

PRACTICAL COMPUTING

FOR BUSINESS AND PROFESSIONAL MICRO USERS



MULTI-USER STRATEGIES

HARDWARE IBM PS/2 Model 30

Epson's laser printer • Macintosh SE

SOFTWARE WordStar 4 • A-T's Rapid File

PLUS Aldus PC Pagemaker

THE NEW SOFTWARE
OS/2 AND
AFTER

The secret of Borland's success is "Quality, Speed, Power, & Price"

We're one of the biggest software companies in the world—and we got that way by making "Quality, Speed, Power, & Price" essential characteristics of every Borland software program. Look for Borland software—then look no further.



Turbo Prolog™

Our new Turbo Prolog has drawn rave reviews—which we think are well deserved—because Turbo Prolog brings 5th-generation language and super-computer power to your IBM PC and compatibles. Turbo Prolog is a high-speed compiler for the artificial intelligence language, Prolog, which is probably one of the most powerful programming languages ever conceived. We made a worldwide impact with Turbo Pascal, and you can expect the same results and revolution from Turbo Prolog, the natural language of Artificial Intelligence. Minimum memory: 384K.

Reflex® and Reflex Workshop™

No matter what business you're in, if you use Lotus 1-2-3® or dBASE® you need Reflex and the new Reflex Workshop to give you all the tools and views to see what your numbers mean. The new Reflex 1.1 with expanded memory support allows you to manage huge databases of up to 8 megabytes of RAM, 32,000 records, and 250 fields per record with "Reflex Lightning Speed." The Reflex Workshop gives you a wide range of analytical tools written for specific applications like Finance/Accounting, Administration, Sales and Marketing, and Production and Operations. You can use the tools "as is" or modify them to suit your business needs. Minimum memory: 384K.

SuperKey® Turns 1000 Keystrokes into 1!

If you use SideKick, you need SuperKey. They're designed to work together—and work for you. SuperKey's an amazing keyboard enhancer for your IBM PC and compatibles. With easy-to-write macros, you and SuperKey can turn 1000 keystrokes into 1. Minimum memory: 128K.

SideKick® Instant Desktop Management!

Powerful desktop management program and the #1 best seller for the IBM PC. SideKick includes notepad, calendar, calculator, appointment scheduler, telephone directory, autodialer, and ASCII table. It's RAM-resident—which means SideKick is always there ready to react when you need to do something, call someone, or find out something in a hurry. And it does all this while you run other programs. Minimum memory: 128K.

Traveling SideKick®

It's the electronic organizer for this electronic age. Neither you nor your secretary need to face 1987 with old-fashioned 1887 diaries. Traveling SideKick has everything they have—and a lot more. (Unlike dusty old diaries, Traveling SideKick doesn't "expire" at the end of '87, because it's electronic and good for '88, '89, '90 and on and on and on.) It's a professional binder, a software program, and a report generator—a modern business tool that prints your ever-changing appointments in daily/weekly/monthly/yearly form. (If your schedule changes hourly Traveling SideKick handles the changes instantly.) Whether you use your own personal computer or have someone's help with that, Traveling SideKick is the smart new way to take your computer with you—without taking your computer with you. Minimum memory: 256K.

Turbo Lightning® Solves All Your Spelling Problems!

While you use SideKick, Reflex, Lotus 1-2-3®, and most popular programs, Turbo Lightning proofreads as you write! If you misspell a word, Turbo Lightning will beep at you instantly, and suggest a correction for the word you just misspelled. Press one key, and the misspelled word is immediately replaced by the correct word. And if you're ever stuck for a word, Turbo Lightning's thesaurus is there with instant alternatives. Minimum memory: 256K.

Lightning Word Wizard™ Technical Reference Manual For Turbo Lightning!

An important addition to Turbo Lightning, Lightning Word Wizard includes fascinating and challenging word games like "Akerue" (try reading that backwards), "That's Rite," "CodeCracker," "CrossSolver," "MixUp," and "FixUp," to name some of them. Lightning Word Wizard introduces you to the "nuts and bolts" of Turbo Lightning technology, and gives you more than 20 different-calls to the Lightning engine. Minimum memory: 256K.



Turbo Pascal, the worldwide standard in high-speed compilers, and Family.

Turbo Database Toolbox®

A perfect complement to Turbo Pascal, because it contains a complete library of Pascal procedures that allows you to search and sort data and build powerful database applications. It comes with source code for a free sample database—right on disk. Minimum memory: 128K.

Turbo Editor Toolbox®

Recently released, we call our new Turbo Editor Toolbox a "construction set to write your own word processor." Source code is included, and we also include MicroStar, a full-blown text editor with pull-down menus and windowing. It interfaces directly with Turbo Lightning to let you spell-check your MicroStar files. Minimum memory: 192K.

Turbo GameWorks®

Turbo GameWorks is what you think it is: "Games" and "Works." Games you can play right away (like Chess, Bridge and Go-Moku), plus the Works—which is how computer games work. All the secrets and strategies of game theory are there for you to learn. You can play the games "as is" or modify them any which way you want. Source code is included to let you do that. Minimum memory: 192K.

Turbo Tutor® 2.0

The new Turbo Tutor can take you from "What's a computer?" through complex data structures, assembly languages, trees, tips on writing long programs in Turbo Pascal, and a high level of expertise. Source code for everything is included. New split screens allow you to put source text in the bottom half of the screen and run the examples in the top half. There are quizzes that ask you, show you, tell you, teach you. Minimum memory: 192K.

Turbo Graphix Toolbox®

Includes a library of graphics routines for Turbo Pascal programs. Lets even beginning programmers create high-resolution graphics with an IBM,® Hercules,™ or compatible graphics adapter. Our Turbo Graphix Toolbox includes all the tools you'll ever need for complex business graphics, easy windowing, and storing screen images to memory. It comes complete with source code, ready to compile. Minimum memory: 192K.



Introducing Turbo Basic, the high-speed BASIC you'd expect from Borland!

Turbo Basic is the BASIC compiler you've been waiting for. And it's so fast that you'll never have to wait again. Turbo Basic is a complete development environment; it includes an amazingly fast compiler, an interactive editor, and a trace debugging system. Because Turbo Basic is compatible with BASICA, chances are that you already know how to use Turbo Basic.



Only £ 69.95

With Turbo Basic your only speed is "Full Speed Ahead"!

You probably already know us for both Turbo Pascal® and Turbo Prolog™. Well, we've done it again!

We created Turbo Basic, because BASIC doesn't have to be slow.

In fact, building fast compilers is a Borland specialty; both our Turbo Pascal and our Turbo Prolog outperform all their rivals by factors, and with Turbo Basic, we're proud to introduce the first high-speed BASIC compiler for the IBM® PC. If BASIC taught you how to walk, Turbo Basic will teach you how to run!

Turbo Basic ends the basic confusion

There's now one standard: Turbo Basic. It's fast, BASICA-compatible, and because Turbo Basic is a Borland product, the price is right, the quality is there, and the power is at your fingertips. You see, Turbo Basic's part of the fast-growing Borland family of programming languages — we call it the "Turbo Family". Hundreds of thousands of users are already using Borland's languages, so you can't go wrong. So join a whole new generation of smart IBM PC users — get your copy of Turbo Basic today. You get an easy-to-read 300+page manual, two discs, a free MicroCalc spreadsheet and an instant start in the fast new world of Turbo Basic. All of this for only £ 69.95... Order your copy of Turbo Basic today!

Free spreadsheet included, complete with source code!

Yes, we've included MicroCalc, our sample spreadsheet editor, complete with source code, so that you can get started right away with a "real program". You can compile and run it "as is," or modify it.

A technical look at Turbo Basic

- Full recursion supported
- Standard IEEE floating-point format
- Floating-point support, with full 8087 (math co-processor) integration. Software emulation if no 8087 present
- Program size limited only by available memory (no 64K limitation)
- EGA and CGA support
- Access to local, static, and global variables
- Full integration of the compiler, editor, and executable program, with separate windows for editing, messages, tracing, and execution
- Compile, run-time, and I/O errors place you in the source code where error occurred
- New long integer (32-bit) data type
- Full 80-bit precision
- Pull-down menus
- Full window management

→ circle 101 on enquiry card ←

Borland products are trademarks or registered trademarks of Borland International, Inc. or Borland Analytica Inc. Other brand and product names are trademarks of their respective holders. Copyright 1987 Borland International



Vive la différence

DEPARTMENT A7
1, GREAT CUMBERLAND PLACE
LONDON W1H 7AL
(01) 258-3797

YES! I want the best!

Copies	Product	Price	Totals
___	Turbo Basic	£ 69.95	£ ___
___	Turbo Pascal (PC/MS-DOS)	69.95	£ ___
___	Turbo Pascal (Amstrad CP/M)	59.95	£ ___
___	Turbo C	89.95	£ ___
___	Turbo Prolog	69.95	£ ___
___	Reflex: the Database Manager	*129.95	£ ___
___	Reflex Workshop	69.95	£ ___
___	Reflex & Reflex Workshop	**129.95	£ ___
___	Turbo Numerical Methods Toolbox	69.95	£ ___
___	Turbo Database Toolbox	49.95	£ ___
___	Turbo Graphix Toolbox	49.95	£ ___
___	Turbo Tutor 2.0	39.95	£ ___
___	Turbo Editor Toolbox	49.95	£ ___
___	Turbo GameWorks	49.95	£ ___
___	Turbo Lightning	69.95	£ ___
___	Lightning Word Wizard	49.95	£ ___
___	Turbo Lightning & Lightning Word Wizard	99.95	£ ___
___	SideKick	69.95	£ ___
___	Travelling SideKick	69.95	£ ___
___	SideKick & Travelling SideKick	125.00	£ ___
___	Superkey	69.95	£ ___
___	Turbo Jumbo Pack	245.00	£ ___
___	Outside UK add £10		
___	shipping per copy	£	
___	Add 15% VAT	£	
___	Amount enclosed	£	

Prices include shipping to all UK cities
Carefully describe your computer system: A7

My computer's name and model is _____

The disc size I use is 5 1/4" 3 1/2" 3"
Payment: Access Visa Money order Cheque
Credit card expiration date _____
Card No. _____

Signature _____
Name _____
Shipping Address _____

Postal Code _____
Telephone _____

CODs and purchase orders WILL NOT BE accepted by Borland. Outside UK make payment by credit card or International Postal Money Order.

*New UK version
**Time limited promotional offer
NOT COPY PROTECTED
60 DAY MONEY-BACK GUARANTEE

If within 60 days of purchase you find that this product does not perform in accordance with our claims call our customer service department and we will gladly arrange a refund.
All prices are suggested list prices and are subject to change without notice.

"Borland has created the most powerful version of BASIC ever... Turbo Basic compiles faster than anything I have seen. What's more, the programs it creates execute faster than those produced by other compilers"
Ethan Winer, PC Magazine
Borland's Turbo Basic has advantage over the Microsoft product, including support of the high speed 8087 math chip.
John C. Dvorak

System requirements
IBM PC, XT, AT and true compatibles. PC-DOS (MS-DOS) 2.0 or later
Hard disk or floppy drive. 320 kb

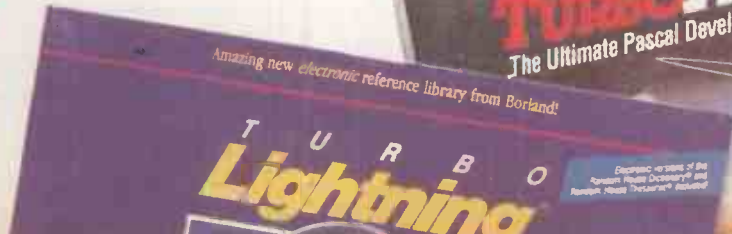

BE 1070



A Minstrel 4 eight-user package – £15,465 complete INCLUDING LASER PRINTER

We've built a proven reputation as leading Specialists in multi-user networking. Each Minstrel computer provides performance and flexibility for 2 to 16 users operating their own individual processors.

- From 2 to 4080 Simultaneous users (up to 16 per machine)
- From 0 to 4080 printers (up to 16 per machine)
- Up to 147,900,000,000 characters of on-line storage (580Mb per machine)
- Network in up to 254 IBM PCs of any description.

Currently, we're offering an eight user Minstrel

system with integral tape back up, a laser printer and a Minstrel office automation Softpack. All for £15,465 excluding VAT. 145Mb formatted capacity Winchester Disk Drive is £3,725 extra. Each additional 2 users are £2190 complete.

Additional high performance software for accounting, point of sale, hospital administration, databases and many other applications are also available.

For further information simply call us or send the coupon below.

HM Systems plc

HM Systems plc,
220 The Vale, London NW11 8HZ.
Telephone: 01-209 0911.
Telex: 266828-HMS G

Please send me full details on Minstrel multi-processor systems.

Name _____

Title _____

Company _____

Address _____

Phone _____

PC7

NEW MINSTREL 4 E.P. OUT NEXT MONTH .. FASTER AND BETTER!

→ circle 138 on enquiry card ←



MULTI-USER STRATEGIES

The latest generation of 80386- and 68020-based micros provides hardware power in abundance for multi-user computing. But what about the software? In this special section we look at the leading operating systems — Unix, Concurrent DOS, Pick and BOS — and assess their strengths and weaknesses **87**

INSIDE



Zenith Z-386 A challenger for the Deskpro 386 — page 42.



PC Pagemaker Aldus DTP goes IBM — page 56.



PRACTICAL COMPUTING

JULY 1987 CONTENTS

ZENITH Z-386

While the world waits for IBM's 386 micro, other manufacturers continue to plug the gap with their own offerings. *Steve Malone* tries out Zenith's latest machine **42**

IBM PS/2 MODEL 30

Last month we looked at the theory of the new IBMs; this month *Glyn Moody* puts the first model through a full hands-on bench test **44**

EPSON GQ-3500

Ian Stobie finds out whether Epson's eagerly awaited first laser will repeat the company's success with dot-matrix machines **46**

MACINTOSH SE

An in-depth look by *Carol Hammond* at Apple's open Macintosh **48**

ALDUS PC PAGEMAKER

The top DTP package on the Mac is now out in the PC version, running under Windows: it could point the way for future OS/2 packages **56**

MICROCHART PLUS

Steve Malone reports on the capabilities of a mid-range presentation-graphics program **60**

WORDSTAR 4

Susan Curran looks at the extra features now on offer to the WordStar-using multitudes **67**

RAPID FILE

New packages from Ashton-Tate are always an event. *Mike Lewis* finds out whether this mid-range database was worth the wait **71**

CONSUMABLES

Buying a micro is a big one-off cost but running expenses can mount too. *Carol Hammond* looks at how to get the best deal for floppies, paper, ribbons and the rest **76**

CHIP WARS

The dispute over cheap Japanese chips has highlighted the vulnerability of European micro makers. *Steve Malone* fills in the background **78**

AFTER OS/2

Ian Stobie reports on how the software houses are coming to terms with the new operating system **81**

ADD-ON BOARDS

We pick 10 ways to titivate your micro **99**



IBM PS/2 We look at the Model 30 — page 44.



Macintosh SE Open-minded Mac Plus — page 48.

NEWS

HARDWARE NEWS	
Hewlett-Packard networks	12
SOFTWARE NEWS	
DR applications programs	13
GENERAL NEWS	
Independent Apple software	18

REGULARS

EDITORIAL	
Decision time for ICL.....	7
SOFTWARE WORKSHOP	
Getting to grips with Grep	23
COMMS LINK	
Telecom Gold's new features	27
CHIP-CHAT	
Cheap components.....	29
LEGAL STATEMENTS	
Software clones.....	36
ASK PC	
Can you read from microfiche?	40
BOOKS	
Big Blue exposed.....	105
DOS UTILITIES	
Finding space for your files	107

Test drive **ZENITH'S** 'Supermicro'

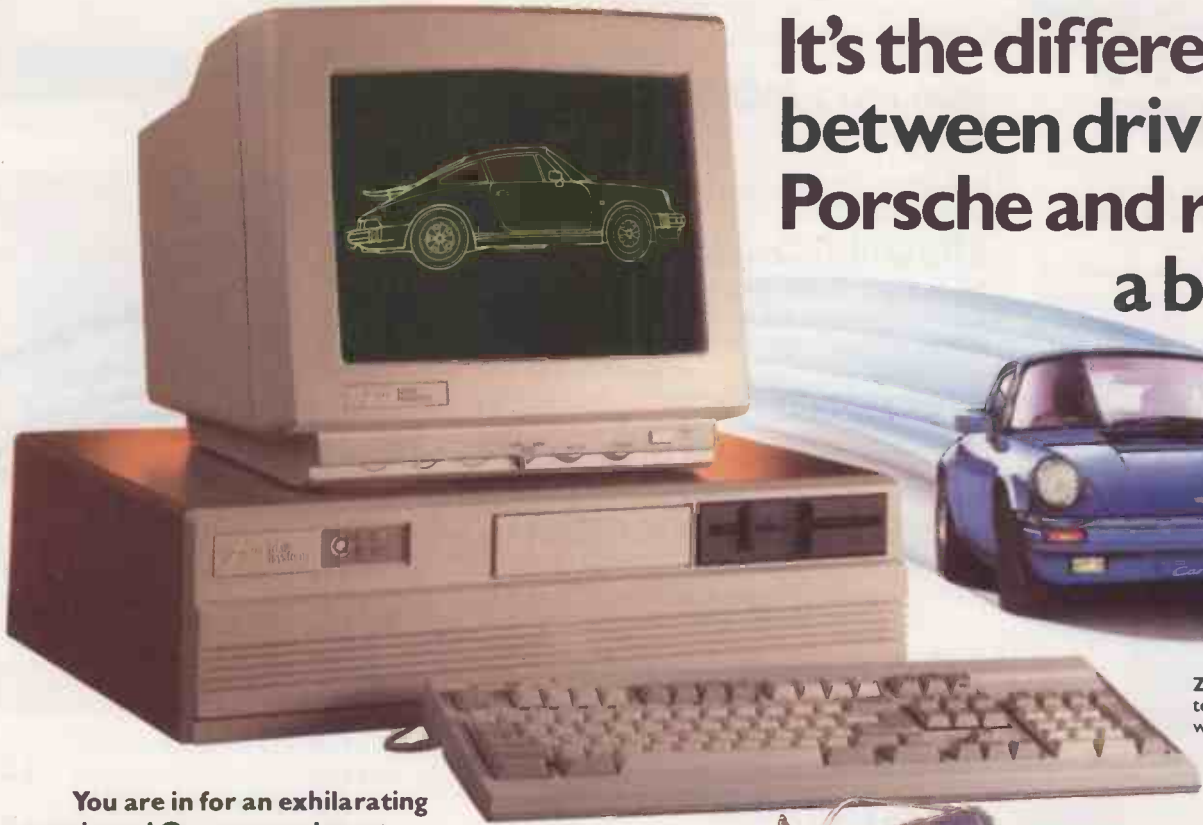

It's the difference
between driving a
Porsche and riding
a bike!

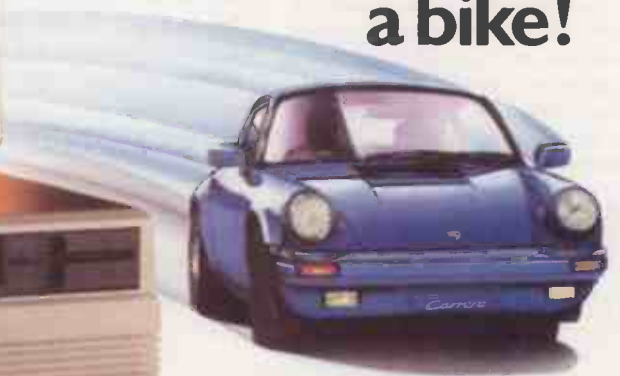

Z-386 32 bit
technology at 16MHz
with 1Mb of RAM.

You are in for an exhilarating experience! Our new and most powerful model, the Z-386, brings supermicro performance to the desktop PC.

To quote 'The Times' it is "The ideal workhorse for Local Area Network (LAN), file servers, Computer Aided Design (CAD), desktop publishing, window applications and program development."

Zenith Data Systems lead the world in multi-tasking, zero-wait-state technology. The Z-386 is part of a full range of advanced portable and desktop systems which includes the Z-248, the world's biggest selling AT, and the powerful Z-159, our enhanced XT PC.

To test drive a Z-386, or to read the brochure, post the coupon, call **0800 444124** or contact one of our national network of authorised dealers and systems houses.

Put your foot down now and move into the winning lane – talk to Zenith.



The world's leading manufacturer of PC compatibles

ZENITH | data systems
'the quiet giant'

See us at 'PC USER' SHOW – STAND 37

To Zenith Data Systems Limited, FREEPOST (BS 333), Bristol BS1 6GZ
 Please arrange a Z-386 test drive without obligation
 Please send brochure (tick appropriately)
 My name _____
 Company _____
 Address _____
 Tel: _____

Circle 126 on enquiry card

PA7

EDITORIAL 01-661 3633 Telecom Gold 81:RPL002 ▷ PUBLISHER/EDITOR GLYN MOODY
DEPUTY EDITOR (Production) JOHN LIEBMAN ART EDITOR HUGH ANDERSON ASSISTANT EDITOR IAN STOBIE TECHNICAL EDITOR STEVE MALONE
REPORTER CAROL HAMMOND EDITORIAL ASSISTANT LOUISE DUFFY CONSULTANTS JACK SCHOFIELD, MIKE LEWIS
ADVERTISING 01-661 3612 ▷ ADVERTISEMENT MANAGER NEIL MARCHANT 01-661 3021
ASSISTANT ADVERTISEMENT MANAGER JANET THORPE 01-661 8626 ADVERTISEMENT EXECUTIVE KATE SCALLY 01-661 8425 JANET THORPE 01-661 3468
MIDLANDS AND NORTH 061-872 8861 ADVERTISEMENT PRODUCTION CONTROL JACKIE PERRY 01-661 8649 BRIAN BANNISTER 01-661 8648
SECRETARY LYNN DAWSON CLASSIFIED SUSAN PLATTS 01-661 3033

DECISION TIME FOR ICL

Try this quiz. Name a major international computer manufacturer, with a turnover measured in billions of dollars, which has increased its sales for each of the last three years by around 10 percent. This company's profits went up by 27 percent last year; it now holds around half of the U.K. multi-user micro market and about 18 percent in Europe. A clue: its name consists of three initials.

The answer, of course, is not IBM — which suffered a fall in profits last year and hardly figures in the multi-user micro arena at all. Surprisingly, the company in question is our very own dapper ICL. Two questions suggest themselves. Is ICL's welcome success likely to be sustained? And how should the company proceed to build on it?

At first glance, ICL is not an obvious candidate for steady growth in today's fickle markets. For a start, it has a pretty odd portfolio of products. It possesses neither the unity of DEC's Vax family, nor the awesome, if somewhat incoherent, breadth of IBM's array of products. Instead, it has adopted a mix 'n' match approach, filling a slot here, and colonising a niche there.

ICL's bottom-end machines are symptomatic of this. The pick of the bunch has to be the One Per Desk work station — an original concept marred by a woefully inadequate implementation. The idea was to bring together computers and communications in a single neat unit for the manager's desk.

At the time of the launch, ICL was confident that this brilliant insight into the nature of executive working would take the world by storm, rendering other PCs obsolete. Unfortunately, things did not quite work out like that. The wonder is not that the One Per Desk bombed so comprehensively, but that it is allowed to linger on as a constant reproach to the company.

Perhaps as a corrective to this wildly visionary product, ICL's other low-end machine is about as conservative as you can get. The multi-user Quattro system is based around an 8088 chip and was grossly underpowered and old-fashioned even when it was launched. Its successor — the DRS-300 series, reviewed a year ago in *Practical Computing* — is better designed, particularly as far as upgrades are concerned. Presumably, it forms the basis of ICL's considerable current success in the British and European multi-user markets.

One reason why ICL seems to have done so well with this motley crew is that far from attempting to offer a consistent, integrated range of products, the company has concentrated increasingly on providing carefully tailored solutions to well-defined vertical markets, working closely with OEMs and VARs. This has worked well so far, but there is still some cause for concern.

Until recently, ICL has avoided any head-on confrontation with rival manufacturers in the sphere of the dominant DOS architecture. The company would doubtless put this down to sound strategy; cynics might see it as a bad case of cold feet. Be that as it may, ICL has now decided belatedly to enter the DOS

world. It has unveiled a version of its DRS multi-user series called the DRS Professional Workstation — the DRS PWS. Unlike its sibling products, this is a single-user machine but a multi-tasking one.

Apart from apparently going against ICL's previous strategy for the lower end of the computer market, the most worrying thing about this new product is the operating systems it will use: MS-DOS 4. Just about every other manufacturer has passed this system over as a complete no-hoper. The appearance of MS-DOS 3.3 and OS/2 confirms the totally inconsequential nature of the product, which must cast some doubt on whether ICL really does have a coherent strategy in this area. If it does not, its successes could evaporate as other manufacturers move in and take over.

However, all is not lost. Just as ICL appears to be losing its nerve, and following a path which everyone else had agreed years ago was a dead end, IBM has kindly stepped in and made such questions irrelevant. The launch of the PS/2 range has made it quite clear that we are entering the second phase of business micros. With the new standard comes ICL's big chance.

Hitherto, it has spurned the mainstream corporate micro market and left business users to buy their standard PC compatibles from elsewhere. This is despite the fact that a misguided sense of patriotism might well have caused them to buy the ICL kit, had it been available. It seems likely that only the bigger companies, like Compaq and Olivetti, will be able to clone the new PS/2 quickly and easily. ICL would be well placed to join that elite club. If it has not already put in an order for the PS/2 Model 50 machine — which uses the mysterious Micro Channel — it should do so immediately, and then gets its research teams busy. Along the way, it might even knock together linking programs to ICL mainframes to complement those which IBM will be offering for its own machines. By its recent successes, ICL has proved it can be a big fish in a small pond; the key question is whether it can manage the same trick in the big pond.

5 YEARS AGO...

A new British microcomputer has been launched, aimed at the top end of the personal-computer market. The M-Three is the latest offering from LSI Computers of Woking in Surrey. The machine is Z-80 based, has 64K RAM, two double-density mini-floppy drives, a VDU with 1,920-character green phosphor display and a full-function keyboard. The keyboard has 14 programmable function keys, and a numeric pad making a total of 109 keys.

M-Three is equipped with a CP/M operating system and is programmable in Basic and Cobol. There is also a range of applications software available from LSI computers. The complete package costs less than £3,000 without software, or £3,500 with one LSI software application included for small-business users.

Volume 5 Issue 7



Olivetti's new M15.

The desk top computer for people without desk tops.

If, like our antiquated architect, you're a businessman who spends a lot of time out in the field, you're sure to welcome the arrival of the new Olivetti M15.

A lightweight computer with heavyweight capabilities.

It weighs in at only 12½lbs – but packed into that 12½lbs is all the performance of a desk top PC.

A 512 KB memory.

Twin integrated 3½" disk drives, with the capacity to transfer data and programmes to and from an external 5¼" drive.

A full 10½" tiltable screen – larger than any other portable. (With normal monitor proportions, to prevent picture distortion.)

And, of course, the standard MS-DOS operating system – making the M15 fully compatible with industry software and hardware.

So you can run all the programmes you've got in the office, out of the office.

The M15 has a dual power supply – 6 hour rechargeable batteries, or mains.

A detachable keyboard – so you don't have to have the whole thing on your lap.

And to round the package off, the computer comes complete with its own holdall. And the service and back-up you'd expect from Europe's leading PC manufacturer.

What you might not expect is the extremely competitive price!

For more information, simply send off the coupon, or talk to your local dealer.

£1355 excluding VAT for the complete system.

To: Carol White, British Olivetti Limited, Olivetti House, 86-88 Upper Richmond Road, London SW15 2UR. 01-785 6666. I'll be out of the office soon. Please send me details of the Olivetti M15 computer.

Name _____ Position _____

Company _____ Address _____

Postcode _____

Tel. No. _____

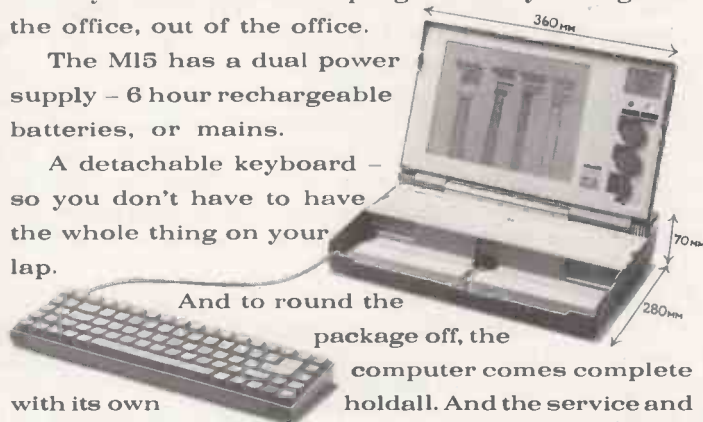

olivetti
YOUR PERSONAL SOLUTION

PC7

How to make sure your Printer doesn't slow your PC down.



See us on stand 66J at the PC user show

Without a Megabuffer your Printer can slow down the rate your PC outputs to the rate your Printer prints. Turning a 5 minute print file into half-an-hour. Which means that the PC can be out of action for long periods. Merely outputting. With a Megabuffer the PC outputs at its top speed into the Megabuffer memory, the PC is then released for further work, and the Printer prints at its own rate from the Megabuffer memory.

- Allows you to use your PC more
- Can emulate special plotter handshake protocols
- Compatible with most computers, printers and plotters: IBM & compatibles, AMSTRAD, HP, ACT, SHARP, EPSON, CALCOMP and many more • Can cut PC output time to one sixth or less.
- Software-independent
- Data Buffer and interface converter
- Pause, 'reprint page' and multiple copy facilities

Full range of memory sizes for every application: 64K **£160**, 128K **£216**, 256K **£278**, 512K **£388**, 1MB **£556**.

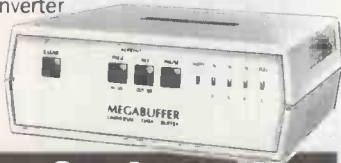

Flexible Interfacing that keeps them all talking

Eliminate miles of spaghetti and all those 'T' and 'X' switches with a simple Megaswitch which allows your PC to instantly connect to a selection of printers and plotters.

MEGASWITCH AS - Serial Data Selector

- Single unit multiplexer and demultiplexer • 2K data buffer
 - RS-232 and RS-422 versions • Can operate as RS-232/RS-422 converter • Diagnostic output • Megabuffer compatible
 - Multiplexer - Ideal for printer sharing. 4 inputs and 2 outputs. Can automatically select any channel supplying data
 - Demultiplexer - Ideal for driving several different printers from a PC. 2 inputs and 4 outputs
- Software and manual selection. Downloadable code translation tables. Hardware and XON/XOFF handshakes

(RS-232) **£189**

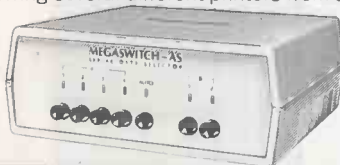

INPUT UP TO 5 PCs

MEGASWITCH S - RS232 Serial Selector

- Connects any of 5 inputs to either of 2 outputs
- Universally compatible - works with all baud rates and handshake arrangements
- LED indication of data flow
- Use it with a Megabuffer for additional time saving **£99**



OUTPUT 2 PRINTERS UP TO 2 PLOTTERS

MEGASWITCH AP - Parallel Data Selector

- Connects any of 4 inputs to either/both of 2 outputs
- Can automatically switch to any channel supplying data
- Ideal for laser printer sharing
- Universally compatible - works with all standard centronics computer and printer interfaces
- Use it with a Megabuffer for additional time saving **£169**

RINGDALE PERIPHERALS

11 Decoy Road, Worthing, West Sussex BN14 8ND
Telephone (0903) 213131
Telex 265871 REF: JBC2021

UK delivery £3/UNIT, cables from £15, VAT extra Dealer and Export Enquiries welcome

→ circle 141 on enquiry card ←

NEXT MONTH

SOFTWARE

Desk-top publishing continues to be one of the hot areas at the moment. We look at **Harvard Professional Publisher**: will it live up to the high standards of the company's other products? Plus a review of **Webster's New World Writer**, a word processor designed specially for writers rather than secretaries.

HARDWARE

Although it was announced some months ago, the **Apricot 386** machine is only just coming through in quantity now. Was it worth the wait, and how will it fare against the 80386 machines - including IBM's - already out there?

FEATURES

Superconductors seem to be bringing science fiction into the realm of fact. We examine the implications for computers and for business. Plus another look at the **Data Protection Act**: has it failed?

SPECIAL SECTION

LASER PRINTERS

A few years ago lasers were luxuries; today it seems that everyone is launching one or buying one. We examine the latest developments, and find out how fast laser printers really are.

TOP 10

UTILITIES

We survey the candidates for every micro user's software toolbox.

Don't miss the August issue of

PRACTICAL COMPUTING

On sale at W H Smith and all good newsagents after 15 July.

Contents may vary due to circumstances beyond our control and are subject to change without notice.

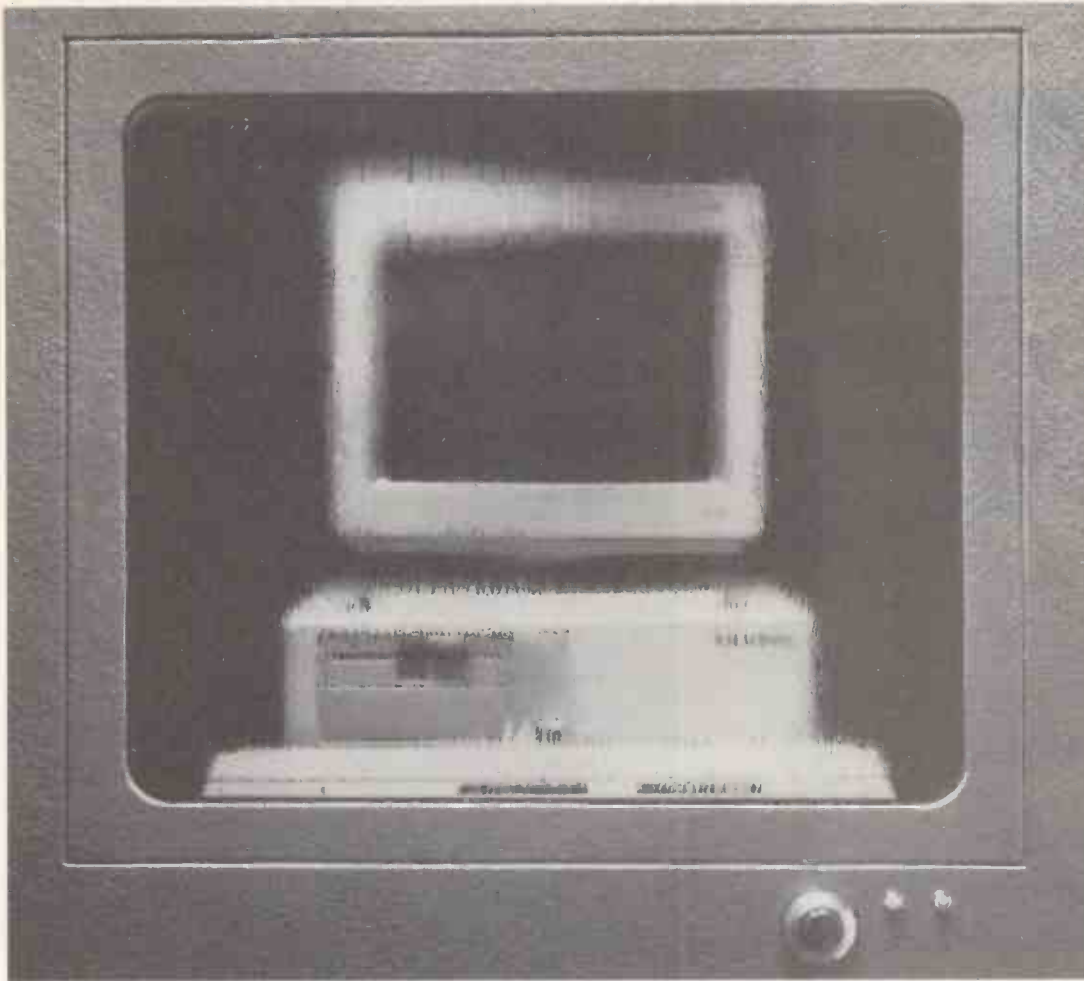

We steamed it.

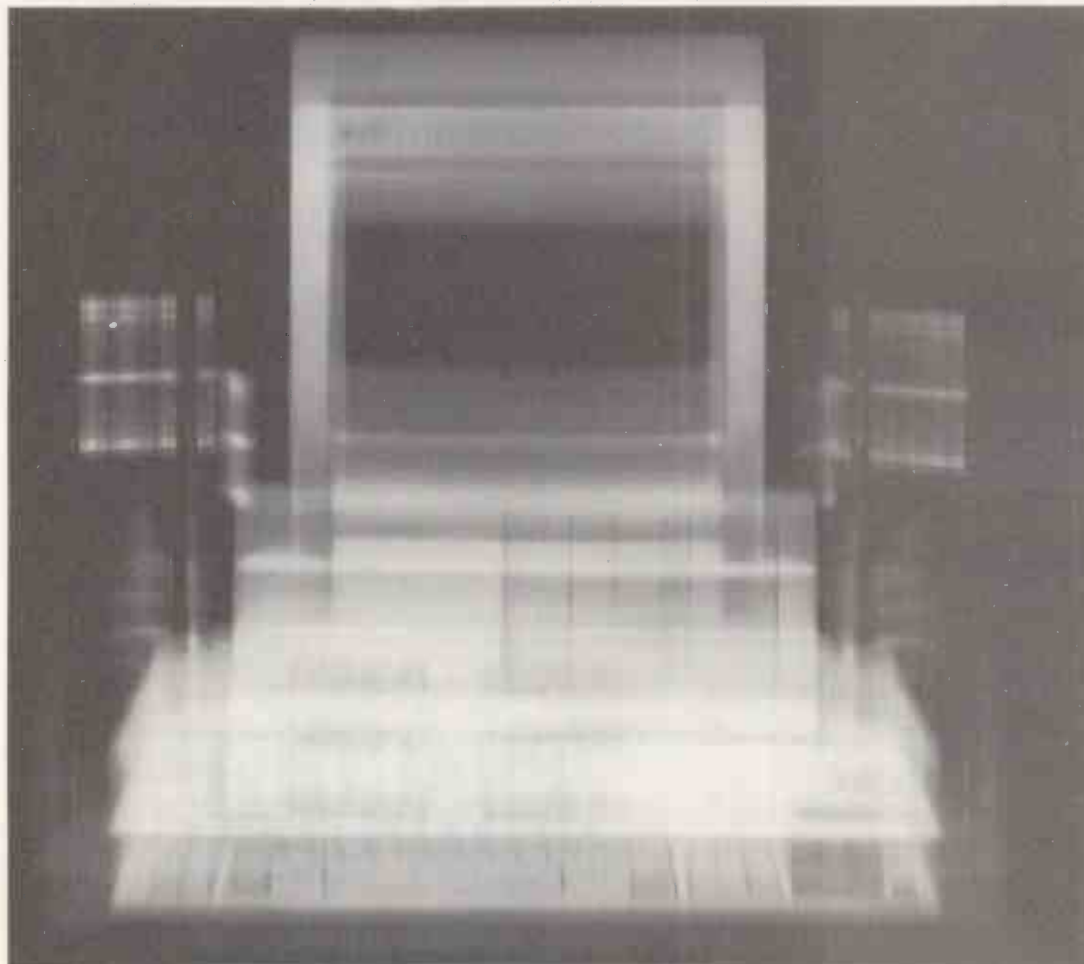

We shook it.





We froze it.



We rocked and rolled it.

To get to your office, the Vectra has to go through hell.

How can we be so sure our Vectra computer won't let you down? Because we asked Lloyd's Register of Shipping to give it a going over.

Lloyd's test all kinds of equipment for seaworthiness. They believe a computer should be able to round the Cape, reach the Pole and spend a week in the Doldrums.

Which is why they tested the Hewlett-Packard Vectra as if lives depended on it.

First, they left it in a temperature of 55°C for 100 hours.

Then they lowered the temperature to -25°C for 16 hours.

In the next test they again raised the temperature to 55°C but this time with a humidity of 95%.

They also rolled the Vectra each side of the vertical, they vibrated it for two hours and they fluctuated and interrupted the voltage and frequency.

The results, we think, will surprise you.

Apart from suggesting we should secure the capacitors and resistor more firmly, Lloyd's gave us a clean bill of health.

For those on dry land, the message is clear.

If the Vectra can cope with life at sea, it should find office life plain sailing.

 **HEWLETT
PACKARD**
We can work it out.

— circle 154 on enquiry card —

Ethernet for IBM and Mac

A RANGE of new products for the IBM PC and the Macintosh II has been announced by 3Com, the US-based network manufacturer.

The Etherlink II card is intended as a successor to the earlier Etherlink adaptor. The new version is claimed to extend the range of a network without the use of repeaters, and is able to use unshielded twisted-pair cables.

The IBM Token Ring adaptor is called Tokenlink and takes over as an entry-level version from the company's Tokenlink Plus adaptor. The Tokenlink card supports both IBM's shielded twisted-pair cable and unshielded telephone twisted-pair cables. Following the announcement of the Tokenlink adaptor, the price of 3Com's Tokenlink Plus card has been reduced by 18 percent and that of the Etherlink card by 17 percent.

In conjunction with Apple 3Com has also developed an Etherlink adaptor for the Mac II to be marketed by Apple under the name of Ethertalk. It plugs into the Mac IIs NuBus expansion slots and will allow users to access the range of Ethernet systems currently available. By this means it can communicate with non-compatible machines on the network, such as IBM PCs.

Further information is available from 3Com, Goswell House, 134 Peascod Street, Windsor, Berkshire SL4 1DS. Telephone: (0753) 868190.

Speedy clone

CLONE manufacturer Digital Matrix has upgraded the maximum speed of its Matrix AT-I clone from 10MHz to 12MHz. The new machine, now called the AT-II, is on a par with the Compaq Portable III in terms of clock speed. As an introductory offer, the machine will have a retail price of £1,199.

Accounts, word processing and database software is being bundled with the standard 20Mbyte hard-disc machine. Options include a 170Mbyte hard disc and 2.2Gbyte optical disc drive.

For further details contact Digital Matrix, 75 Willow Road, Solihull, West Midlands B91 1UF. Telephone: 021-704 1399.

HEWLETT-PACKARD NETWORK OPTIONS

HEWLETT-PACKARD has announced a range of extensions to its Advancenet networking system. The new networks are intended to provide a wide range of business solutions based around the X-25 protocols.

The company is offering five new networks, each one tailored to a specific business requirement. The major announcement is of a wide area network (WAN) based around X-25 and intended to cover an entire company. The significance of X-25 is that it is an internationally accepted standard for network communications which has been adopted by a wide range of manufacturers. Hence the network is able to communicate with a number of otherwise incompatible computers.

The second of the new products is specifically designed for use by

sales and service departments. The network aims to provide access to central processing and local centres. He says that the network is able to cope with a variety of different access methods, including dial-up and X-25 private and public networks.

The Business to Office product is for departmental networks. Local groups in an HP Starlan cluster can be linked together via a backbone network. Away from the office, Hewlett-Packard has designed two networks specifically for the manufacturing process. The Computer Integrated Manufacturing (CIM) network is configured to orchestrate the various controllers and systems installed on the factory floor.

The final network is aimed at design engineers. The Engineering Network is intended to transfer

information between Unix-based cluster work stations, although it will also provide some support for proprietary operating systems, such as those from IBM and DEC.

To support the new set of networks, Hewlett-Packard has released a number of new products. They include the X-25 Private Packet Network, an X-25 Multiplexor and a Buffered Repeater.

The company is also offering several services to support the new products. Network Prepare helps customers integrate the network with their existing hardware, while Netassure is a scheme for contract maintenance.

Further details from Hewlett-Packard Ltd, Enquiry Section, Eskdale Road, Winnersh Triangle, Wokingham, Berkshire RG11 5DZ. Telephone: (0734) 696622.

Parallel processing comes to ATs

MICRO-MARKETING has introduced what is claimed to be the world's first parallel-processing plug-in device for the PC/AT. The IQ-188 is a microcomputer on a board which shares the tasks of the host machine.

The board holds an 80188 processor running at 7.5MHz, a hard-disc controller, 256Kof RAM

and two high-speed RS-232 ports. The RAM is expandable to 1Mbyte and is mapped directly into the AT's address space.

The company claims that the IQ-188 is capable of sorting a dBase file in the background while simultaneously recalculating a Lotus spreadsheet.

The IQ-188 costs \$1,775 for the

256K model, rising to \$1,970 for the 1Mbyte version. Sterling prices vary with the dollar rate. Further information is available from Micro-Marketing (Electronics), Unit 4, Soho Mills Industrial Estate, Wooburn Green, High Wycombe, Buckinghamshire HP10 0PF. Telephone: (06285) 29222.



Portable peripherals

MICROSCRIBE, the manufacturer of hand-held microcomputers, has introduced a built-in printer and portable disc drive for its 600 and Challenger range of machines. The new printer, which is being offered as a built-in option on Microscribe computers, uses thermal roll paper. It can print at 20, 40, 60 and 80 columns with a maximum speed of 65cps to 70cps.

The disc drive is battery

operated and uses 3.5in. discs. It is fed by four AA batteries and connects to the computer via one of the communications ports. The transfer rate to and from the drive is 9,600 baud. Each disc is capable of storing up to 100K.

For information contact Microscribe, Unit 9, Llntaranam Industrial Park, Cwmbran, Gwent NP44 3AX. Telephone: (06333) 73246.

Awesome boost for hard discs

A NEW hard-disc sub-system from CSSL Inc. is claimed to improve dramatically the performance of the PC/AT hard disc. The new product, to be called the Awesome I/O card, is expected to cost \$595.

The Awesome card uses two basic methods of tackling the problem of the I/O bottleneck at the hard disc. The first is to store commonly used accesses in battery-backed CMOS RAM. The second method involves the use of data-compression techniques and cluster compaction. The company claims this increases the disc capacity by at least 50 percent. Data is also retrieved far faster in compacted form.

For more details contact CSSL, 909 Electric Avenue, Seal Beach, Ca 90740, USA. Telephone: (US area code 213) 493-2741.

Victor removable hard-disc modules

VICTOR TECHNOLOGY has improved its range of PC/AT-compatible computers with the launch of the VPC-III. The new machine features the ability to accommodate a second removable hard disc and a flat-screen display.

The removable hard disc, known as the Add-Pak, uses 3.5in. 30Mbyte discs. It is housed in a pull-down flap to the side of the conventional mass-storage devices.

Prices for the VPC-III range start at £2,499 for the 20Mbyte hard-disc machine with monochrome display, rising to £3,899 for a machine equipped with a 40Mbyte hard disc and an EGA display. The Add-Pak disc drives cost £499 each.

For further information contact Victor Technologies (UK), Unit 1, Valley Centre, Gordon Road, High Wycombe, Buckinghamshire HP13 6EQ. Telephone: (0494) 450661.



The Add-Pak removable hard discs slot into the VPC-III.

HARDWARE SHORTS

- NCR has reduced the prices of its Unix-based Tower super-micros by 7.5 percent. The entry-level machine now costs £4,320. Details on 01-725 8337.

- ICCT has introduced the All Card 286, a 16-bit version of its Allcard. The entry-level version without any memory chips installed costs £595. Further information from 01-248 8895.

- The Cipher 1525-CT is a 25Mbyte tape streamer for the Amstrad PC-1512. It is available from First Software. Phone (0256) 463344.

- Video Seven has announced an upgrade for its Vega Deluxe card, which can now support IBM's new Video Graphics Array (VGA) display. Details are available on (0706) 217744.

- The Reel One 20Mbyte tape streamer has been designed to fit into the external floppy-disc drive of the Toshiba portables. For details phone (045382) 3611.

SOFTWARE

Word Perfect for portables

AN INTEGRATED package aimed specifically at business users with lap-portable computers such as the Toshiba T-1100 or Zenith Z-181 is being introduced by Word Perfect Executive. Called Word Perfect Executive, the new package incorporates a spreadsheet and other functions in addition to word processing.

To make the software more suitable for battery-powered use, disc accesses are kept to a minimum. The word processor is a cut-down version of the full Word Perfect, and includes a 50,000-word spelling checker. The spreadsheet has the ability to handle Lotus files, and includes limited database and charting functions. Appointment calendar and alarm pop-ups are also included, along with a simple database and a phone directory.

The package costs £199 on either 3.5in. or 5in. discs. Contact Sentinel Software, Wellington House, New Zealand Avenue, Walton-on-Thames, Surrey KT12 1PY. Telephone: (0932) 231164.

CHANGE OF DIRECTION FOR DIGITAL RESEARCH

IN A move which could herald a shift away from its traditional territory, Digital Research (DR) has launched two significant applications packages: a desk-top publishing program and a word processor.

Gem Desktop Publisher goes on sale immediately at a cost of £295. This pricing means that it is aimed at the bottom end of the DTP market, at users who do not require all the features offered by Aldus and Ventura, but who still want to go a step beyond ordinary word processing. DR hopes it will appeal not so much to the home market but to corporate users put off by the undoubted complexity of the more expensive products.

Gem 1st Word Plus, which goes on sale at the same time, is a bought-in product, acquired on a worldwide basis from GST, a Cambridge-based software house. GST keeps the rights to versions for the Atari ST and other non-IBM compatible machines.

Most users will pay £149.95 plus VAT for Gem 1st Word Plus, getting Gem Paint and the Gem



Gem Desktop Publisher's automatically wraps text round pictures.

Desktop bundled in free. Amstrad PC-1512 users will only have to pay £79.95, including VAT; according to DR this is because they already have the two other Gem programs.

Gem 1st Word Plus is a very Macintosh-like word processor. It makes full use of Gem features, allowing you to have up to four documents open at a time, and to browse and copy text between

them. Mail-merging and a 40,000-word spelling checker are included, as well as the ability to incorporate image files.

In the past Digital Research has always been associated with operating-system and language products. It is the company responsible for CP/M, and more recently for Concurrent DOS and

(continued on next page)

(continued from previous page)

the Gem graphics environment. However, the heart of this market is now occupied by Microsoft, with DR pushed into doing the bulk of its business in a rather fragmented way at either end, in the low-cost Amstrad arena or at the specialised VAR and system house end. Application packages provide a way for DR to get back into the more lucrative mainstream areas on a more favourable basis.

For more information contact Digital Research, Oxford House, Oxford Street, Newbury, Berkshire RG13 1JB. Telephone: (0635) 35304.

Inmac's software products

CONSUMABLES giant Inmac has entered the software field for the first time with two pop-up programs for Lotus 1-2-3. The most interesting is Inword, a full-feature word-processing program costing £68. It lets you link spreadsheet data into documents dynamically; it can also be used to prepare personalised form letters and mailing labels from Lotus data.

Noteworthy costs £54. It lets you attach explanatory notes to the cells in your spreadsheet, allowing up to 8K of text per cell. Like Inword, it was written by Funk Software in the US, and uses the facilities Lotus provides within 1-2-3 version 2 to hook third-party products into the package.

Inmac, one of the largest computer consumable companies in the UK, sells direct to the public. One of the welcome effects of this kind of company getting involved in software distribution may be to improve purchase terms for end-users. Inmac is offering both products with a 30 days carriage-paid money-back trial period and a 12 month guarantee.

Contact Inmac (UK), Westerley Point, Market Street, Bracknell, Berkshire RG12 1EW. Telephone: (0344) 424333.

PRESENTATION SOFTWARE CHOICE GROWS

THREE strong presentation-graphics packages are about to come on to the market. Two of them are established products, the third is new.

Harvard Presentation Graphics is one of the UK's best-selling packages of this type. The new version is called Harvard Graphics and goes on sale in the summer. It is expected to cost slightly more than the £295 being asked for the current version.

New features include a symbol library and an improved free-running carousel-type display. The number of chart types has been boosted, and three-dimensional effects are now available.

Contact Software Publishing Europe, 85-87 Jermy Street, London SW1Y 6JD. Telephone: 01-839 3864.

Boeing Graph is a new colour version of Perspective, a more specialised presentation package. Perspective's claim to fame is that you can use it to produce three-dimensional effects, as well as flat charts. Part of the Boeing Company has done a deal with Three-D Graphics, the program's originator, to jointly produce Boeing Graph. It goes on sale here later

this month, priced at under £400.

Much of Boeing Graph's appeal comes from the fact that you can rotate and zoom the images along any axis, producing stunning effects. New features include more chart types, and support for more printers and file formats. Boeing Graph should be available almost immediately, priced at under £100. Contact Persona, Unit 1, Silverglade Business Park, Leatherhead Road, Chessington, Surrey KT9 2NQ. Telephone: (03727) 29611.

VP-Graphics is the latest offering from Adam Osborne's Paperback Software range. The VP products are usually very good value for money, and VP-Graphics will probably be no exception. You can import ASCII, Pic or DIF files from elsewhere or enter data directly into the package. Along with a wide range of data-driven chart types, VP-Graphics has a large selection of drawing tools inside the package.

VP-Graphics goes on sale later this month. Contact Newstar Software, 200 North Service Road, Brentwood, Essex CM14 4SG. Telephone: (0277) 220573.

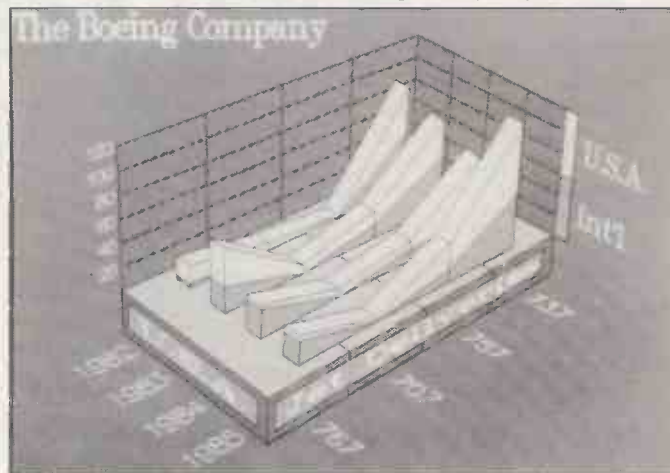

Boeing Graph provides versatile three-dimensional effects.

SOFTWARE SHORTS

● Xerox has released version 1.1 of Ventura Publisher. Enhancements include faster printing, automatic kerning, anglicised hyphenation, and considerably expanded facilities for importing graphics. Contact Rank Xerox on (0895) 51133.

● Psion has released a Lotus-compatible spreadsheet and comms software for its tiny Organiser II hand-held computer. The spreadsheet, which costs £39.95 including VAT, can handle WKS, WRL and DIF files. Used together with the £59.95 comms program it lets you download, manipulate, then upload Lotus files from your office PC. Details from Psion on 01-723 9408.

● Project-management software is not as widely used here as in the US, because few people understand the underlying discipline. Project Helper sets out to change this: it is both a tutorial program and a small project-planning package capable of handling projects with about 100 activities. It costs £78.25 from Parkway Computer Consultants, telephone (0707) 371616.

● dPops is an £30 add-on for dBase III Plus. It lets you output things like instructions, help or error messages in windows which pop up over the ordinary dBase display. Contact Camel Services on (0865) 512675.

● Multiword is a new word-processing and mailing package which links through to the Multisoft range of accounting software. The single-user MS-DOS version costs £390; it is also available under Xenix. Contact Multisoft Systems on (0420) 85572.

● Trendtext/Expert is latest in the Microtrend range of word-processing packages. Features include extensive mail-merge and a spelling checker. The price is £349. More details from Microtrend on (0423) 711878.

● Wordmarc Author is a simplified PC version of a word processor which also runs on Vax and Prime minis. The advantage of using the £200 package is that you can transfer documents both ways. Contact Doric Computer Systems on (0923)52288.

Hard-disc file-security software

STOPLOCK IV is a menu-driven hard-disc security system aimed mainly at large corporate PC or AT users. The £550 product takes the form of an expansion card rather than disc software, as this makes it harder to tamper with. Users get access to the system by typing in a valid ID followed by a password; after that

everything works as it would normally.

Stoplock can be set up to support up to 32 different users, all with different file-access rights. The system also has a real-time clock for logging and controlling access times, and supports automatic file encryption, permanent

file erasure, and extensive audit trail and reporting facilities. These features are all controlled through software built on to the card.

The company launching the product is PC Security, The Old Court House, Trinity Road, Marlow, Buckinghamshire SL7 3AN. Telephone: (0628) 890390.



that you've chosen a printer that is fast, reliable, easy to use and what is more, get's the job done first time.

Take the S series for example. A collection of 9-pin matrix printers designed for today's business user. From the 120 cps SG-15 to the 200 cps SR models, all provide excellent value for money. Indeed, measured against the competition, you could be getting as much as 25% more for your money.

and many...
 Countless users
 have made the right
 decision -
 why not join them?

Star Micronics U.K. Ltd.
 Craven House,
 40 Uxbridge Road,
 Ealing, London W5 2BS.
 Telephone 01-840 1800.

THE Star
 PRINTERS FOR BUSINESS

A division of Star Micronics Co., Ltd., Japan

I would like to be sure I'm making the right decision. Please send me details on the Star range of printers.

Name _____
 Company _____
 Address _____
 Postcode _____ Telephone _____
 Or just call Belinda on 01-840 1829. ICT0111

All Star printers give exceptional print clarity, even in draft mode. The S series has one of the clearest draft fonts available and its near letter quality printing has been widely acclaimed by reviewers and users alike.

Of course, the S series is fully IBM compatible, ensuring that it will work happily in any modern business environment, using either serial or parallel versions.

Whether your paper requirements are for single sheets or continuous with additional copies, the SR range has a tractor feed as standard. The SR models even come with an automatic single sheet feed to make your letterheads really easy to load. The Star pedigree is inherited from many years in the manufacture of precision machine parts and a long

He's made the right decision... So can you.

It's not easy choosing a printer.

So many to choose from, so many different features.

But more and more companies are discovering that after looking at the Star printer range there is no doubt as to the right choice.

Take the ND-15 and the NR-15 for example.

Both are IBM compatible, offering proportional, elite, pica, expanded, super and subscripts in NLQ.

Which means they're ideal for word processing as well as spreadsheets and listings.

With 180 CPS in draft mode and 45 CPS in near letter quality mode for the ND-15 and 240 CPS in draft mode and 60 CPS in near letter quality mode for the NR-15 you won't be kept waiting for your copies.

Every function you'd normally use is on a single touch panel on the front of the printer. The ND-15 and NR-15 let you forget the days of fiddling with little dip switches.

Add to that the fact tractor and single sheet feed are fitted as standard and you'll see you're looking at a pair of star performers.

All Star printers are supported through a nationwide dealer network backed-up by the finest distributors, so you're never on your own.

Discover the Star printer range today.

Fill in the coupon or just 'phone Belinda on 01-840 1829 for more information.

It'll be one decision you certainly won't regret.

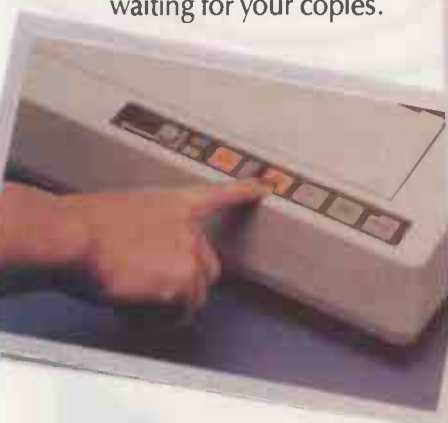

Star Micronics U.K. Ltd.
 Craven House,
 40 Uxbridge Road,
 Ealing, London W5 2BS.
 Telephone: 01-840 1800.

THE **Star**
 PRINTERS FOR BUSINESS

A division of Star Micronics Co., Ltd., Japan.

I would like to be sure I'm making the right decision. Please send me details on the Star range of printers.

Name _____

Company _____

Address _____

Postcode _____ Telephone _____

Or just call Belinda on 01-840 1829.

DPC/7

→ circle 128 on enquiry card ←

The new IBM PC Marry into the future w

The IBM Personal System/2™ range will change the face of personal computing. But even though they have been designed for the future, we haven't forsaken the good things we have created in the past.



*Introducing the new family:
designed for today and tomorrow.*

We've taken great care to ensure that existing IBM PCs can get along perfectly with the new Personal System/2 models.

Take software for example. The Personal System/2 is compatible with most of the software application programs written for the IBM PC family.

And, since the Personal System/2 family uses new compact 3.5 inch diskettes, we offer a series of easy-to-use converters, so that your software applications and data can be simply transferred to your Personal System/2 models.

There are presently three types of converters. One allows current IBM PCs to read data stored on the new diskettes, another allows the Personal System/2 to run programs and read files written on your current



5.25 inch floppies, while a third lets you transfer data directly from the existing family to the new.

So if you're already using IBM PCs your investment is protected.



*The new family can work hand in hand
with your current IBM system.*

Today it is essential that computer users can communicate with each

Personal System/2. Without divorcing the past.



products and service. Improved manufacturing and testing methods, combined with surface mounted technology, result in better performance, lower power consumption and increased reliability. And, since many of the functions previously on optional adapter cards are integrated, you have less connections to worry about.

The place to learn about the future is from the people that have helped you in the past. Our IBM Authorised Dealers will tell you more about the IBM Personal System/2; how you can fit it into your present information processing network today, and what it can do for you tomorrow.

other. With the new Personal System/2 no product is an island.

The Personal System/2 is able to connect in all directions. It connects up to more powerful IBM systems, down to less sophisticated personal computers, back to previous models of the IBM PC family, forward to products we may announce in the future, and sideways to outside information sources.

One Personal System/2 feature is a perfect example of our commitment to the past; IBM's continuing dedication to the highest quality

The IBM Personal System/2 family.



Model 30-002



Model 30-021



Model 50

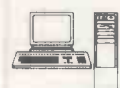

Model 60-041

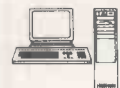

Model 60-071

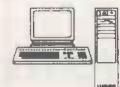

Model 80-041



Model 80-071



Model 80-111

For more details and a list of IBM Authorised Dealers, contact Wendy Castle at The National Enquiry Centre, IBM United Kingdom Limited, 414 Chiswick High Road, London W4 5TF. Or telephone 01-995 7700 during working hours.

Name _____

Position _____

Company _____

Type of Business _____

Address _____

Postcode _____

Phone (Work) _____



APPLE TO LAUNCH A SOFTWARE COMPANY

APPLE Computer Inc. has announced plans to create an independent software company to develop, publish and market applications software for Macintosh and Apple II micros. According to Apple, the new company will market applications software currently published by Apple, but under its own private label. It will also publish software developed by third parties while developing some applications itself.

The new company will initially be a wholly owned subsidiary of

Apple, but will probably become independent of its parent within a year. Apple intends to retain a minority share ownership.

An Apple spokeswoman said that the company was formed to stimulate further activity in the software field. Apple itself will become more like a traditional computer manufacturer, concentrating on hardware, peripherals, systems software and comms products.

Initially the change will have little effect in the UK. But as the

new company starts to distribute applications packages like Appleworks, Applewrite, Macpaint, Macwrite and Macterminal, Apple UK will cease to stock them. Apple will redeploy staff currently employed in developing, marketing and distributing applications software to work in different areas within Apple.

For more details contact Apple Computer UK, Eastman Way, Hemel Hempstead, Hertfordshire HP2 7HQ. Telephone: (0442) 60244.

SHORTS

- Dial Computing, the directory of computer manufacturers and suppliers, is available free to commercial computer users. Ring (0342) 26972.

- A Torus user group has been formed to exchange information on Torus networks. Annual membership costs £75. Contact 01-353 5212.

- Commodore International announced net sales of \$160.5 million and a net income of \$1 million for the fiscal quarter ended 31 March 1987. This compares with net sales of \$182.3 million and a net loss of \$36.7 million for the same quarter a year ago.

- The Inland Revenue has issued a leaflet called *Computerised Payroll*. It aims to show the benefits of running your payroll on computer, and gives hints on where to start. It is available from tax offices.

Unix on show

THE European Unix User Show took place in London between 20 May and 22 May. Among the list of exhibitors were IBM, Olivetti, ICL and Apricot, each demonstrating Unix on a range of machines.

Perhaps the most unexpected exhibitor was IBM — not a regular on the exhibitions circuit. The company demonstrated Aix on the 6150 RT/PC. It also gave visitors a sneak preview of the PS/2 Model 60, although this machine was running MS-DOS, not Unix.

Olivetti had the largest stand at the exhibition, right in front of the main entrance. It showed its commitment to the AT&T 3B minicomputer as well as its more conventional range of personal computers. Given the company's close alliance with AT&T, it was not surprising to find that the Olivetti stand was one of the few running the latest Unix System V release 3.1.

Elsewhere, Torch unveiled its 68020 enhancement for the Triple X range, while ICL announced a new version of the Clan and the porting of Unix to the DRS-300. Apricot showed the Xen-i 386 running as an eight-user system under Xenix 386.

European mobile telephone system

BRITAIN, France, West Germany and Italy have agreed on a standard for a Pan-European mobile telephone system. The four countries will join forces to develop a European digital cellular-radio network, which they hope will be in commercial use by 1991. The network will use a narrow-band system.

This is good news for micro users, since not only will people be able to use the same mobile telephone in the UK and Europe, they

will also be able to use the same modem. The digital network will also allow for faster data transmission than is possible with modems currently in use. Modems could eventually disappear altogether if phones begin to incorporate a digital data socket into which micros can make a direct connection.

For more information contact British Telecom, 81 Newgate Street, London EC1A 7AJ. Telephone: 01-726 4444.

Database directories

A NEW series of directories of international databases has been launched. The first of them, called *Business-line Finance*, gives details of over 300 on-line services worldwide that provide information on financial topics.

Business-line Company Information contains entries for over 200 on-line services, covering areas such as company profiles, company accounts and manufacturing output, business opportunities and company products, along with bankruptcies and defaults.

The *Business-line Management, Marketing and Administration* directory lists over 200 on-line services covering topics like personnel management, marketing strategies, audience research, conferences and administration.

Each title costs £85. New editions are published every six months and discounts are available for annual subscribers. For more information contact Euromonitor Publications, 87-88 Turnmill Street, London EC1M 5QU. Telephone: 01-251 8024.

Microsoft's bid for OS-9 rejected

THE SOFT CENTRE, UK distributor for Microware Systems Corp., recently confirmed American rumours that Microsoft has been trying to buy up Microware and that the bid was rejected. Vice-president of Microware, Andy Ball, said that Microsoft's main motive was to get its hands on the OS-9 operating system. OS-9 has been chosen by Philips and Sony as the software standard for the new Compact Disc Interactive (CDI) players.

Microsoft announced its commitment to the CD-ROM text/software standard last year. At the same time Philips and Sony announced the new CDI format, which provides for several levels of audio and video information. The CDI standard defines a filing structure, operating system, microprocessor and associated interactive support software for using compact discs for interactive data, audio and visual recording and retrieval.

For more details contact The Soft Centre, Software House, Burr Street, Luton, Bedfordshire LU2 0HN. Phone: (0582) 405511. 

Data protection guidelines

A SERIES of eight booklets has been issued by the Data Protection Registrar, updating those published in February 1985. The original guidelines were issued as a single booklet divided into sections devoted to principal topics. Each of these topics is now covered by a separate booklet.

The titles in the series are *Intro-*

duction to the Act, The Definitions, The Register and Registration, The Data Protection Principles, Individuals' Rights, The Exemptions, Enforcement and Appeals and Summary for Computer Bureaux. The book on individual rights advises users on how to prepare for 11 November this year — the date on which

members of the public can demand access to information about themselves held on a computer.

All or any of the guidelines are available free from the Office of the Data Protection Registrar, Springfield House, Water Lane, Wilmslow, Cheshire SK9 5AX. Telephone: (0625) 535777.



Hitachi putting pints into half pint pots.



Capacities from 50 Mbytes to 110 Mbytes

In the fast-moving world of computer technology providing the right product at the right time to satisfy industry needs is vital for both the OEM and manufacturer.

Getting it right calls for concentrated measures.

Dedication and in-depth knowledge have their rewards. Things which seemed impossible to achieve a short time ago can be solved by the experts.

The Hitachi range of half height 5¼" disk drives – the DK 521, DK 522 and DK 522C is designed for industry's needs today. Capacities are

51 megabytes and 103 megabytes and a newly designed custom servo control LS1 and rotary voice-coil actuator ensure very fast access times. Industry standard interfaces ST506/401, ESDI and embedded SCSI give ease of integration and enhanced system performance in a wide application area. And that's not all – unbelievably high reliability of 30,000 hours MTBF.

Find out if the DK 521, DK 522 and DK 522C and Hitachi's leading edge technology measure up to your standards.

For more information call Hitachi today.



Hitachi Europe Ltd.
2nd Floor, Trafalgar House,
Hammersmith International Centre,
2 Chalkhill Road, Hammersmith,
London W6 Tel: 01-748 2001

Sole UK Distributor,
Legend Data Products Ltd.,
Littleton House, Littleton Road,
Ashford, Middlesex TW15 1UU
Tel: 0784 242924 Telex: 928723
Legend G. Fax 0784 258954.

-- circle 132 on enquiry card --

The new
Epson laser
costs less than
the paper
it's printed on.

The new laser printer costs £1,795 (ex VAT). The paper it's printed on here costs us nearly twice as much.

(Expensive stuff this advertising lark.) But we reckon it's worth it.

Particularly since this is the only laser printer you can buy with easy-change IC font cards.

What are they? They're unique to Epson. They're about the same size as your credit cards. They slot into the laser and each gives you a variety of fonts extra to the seven we've already built in.

So you can build up a library of them and never be constrained to just printing in the typeface your software package offers again.

Now then, if you're replacing a daisy wheel, sick of the racket your old printers make, need to print really fast, like to use graphics, fancy flexible fonts or have simply never yet found the printer that makes things look as stunning as you want them to, you want our new laser printer.

Right then, here it is, the new Epson GQ3500 (don't we give them pretty names?).

Two easy-change font card slots; seven resident fonts; prints six A4 pages in sixty seconds; 300DPI graphics; 640K memory; SelecType push-button controls for choosing paper size, line spacing, print modes, number of copies portrait or landscape images and all that kind of stuff; IBM compatibility; prints on any standard paper, envelopes or OHP foils.

What are you waiting for? A bribe?

Oh, all right then, buy the new Epson laser and get an HP emulation IC card as standard, absolutely free (normally you'd have to pay us £125 for one).

Now, please fill in the coupon very carefully. There's about a hundred and fifty quids worth of paper there. Don't waste it.



Best hundred and fifty quid you've ever spent, Epson. Send me details of your new GQ3500, quick.

Name _____ Position _____

Company _____

Address _____

To: Epson (UK) Ltd., FREEPOST, Birmingham B37 5BR; alternatively call up Prestel *280# or dial 0800 289622 free of charge.

EPSON

COMPUMART

WATFORD (0923) 55633

IBM

	Mono	Colour
PC XT (SDD):(640k RAM 2 x 360k Disk)	£1100.00	£1290.00
PC XT (SFD):(640k RAM 360k + 20Mb Disk)	£1400.00	£1600.00
PC XT (286):(640k RAM 1.2Mb + 20Mb Disk)	£2000.00	£2200.00
PC ATX:(512k RAM 1.2Mb + 30Mb Disk)	£2975.00	£3170.00

All prices include Keyboard, Monitor & DOS

8087 Chip £195.00 80287 Chip £295.00 AT 360k Disk £145.00

TOSHIBA

Lap Top Computers

T1100:(256k RAM, 3 1/2" 720k Disk, 80C88 Co-pro, DOS 2.1)	£1122.00
T1100 Plus (640k RAM, 2 x 3 1/2" 720k Disks, DOS 3.2, and A/C Adapter-Charger & Carrying Case:	£1450.00
T3100:(640k RAM, 3 1/2" Disk + 10Mb H/Disk, 8MHz 80286 Co-pro, Clock Cal)	£2772.00

olivetti

	Mono	Colour
M24:(640k RAM 360k + 20Mb Disk)	£1683.00	£1897.00
M24SP:(640k RAM 360k + 20Mb Disk)	£1826.00	£2040.00
M28:(512k RAM 1.2Mb + 20Mb Disk Bs. Con)	£2266.00	£2493.00
M28:(512k RAM 1.2Mb + 40Mb Disk Bs. Con)	£2730.00	£2958.00

All prices include Keyboard, Monitor & DOS

COMPAQ

Portables

Portable II Model 2:(256k RAM 2 x 360k Disk)	£1680.00
Portable II Model 4:(640k RAM 360k Disk + 20Mb H/Disk)	£2275.00

COMPAQ PORTABLE III

640k, 286 Processor, 1.2Mb Floppy, 20Mb H/Disk: **£2914.00**

640k, 286 Processor, 1.2Mb Floppy, 40Mb H/Disk: **£3234.00**

Subject to availability

Portable 286 Model 3:(640k RAM 1.2Mb + 20Mb H/Disk + 10Mb Tape)	£3147.00
---	----------

All prices include DOS

Deskpros

Deskpro Model 2:(256k RAM 2 x 360k Disks)	£1307.00
Deskpro Model 3:(640k RAM 360k + 20Mb Disk)	£1797.00

New 12MHz MODELS 50% FASTER

Deskpro 286 20:(640k RAM 1.2Mb + 20Mb Disk)	£2367.00
Deskpro 286 40:(640k RAM 1.2Mb + 40Mb Disk)	£2718.00
Deskpro 286 70T:(640k RAM 1.2Mb + 70Mb Disk + 40Mb Tape Backup)	£4245.00
Deskpro 386 40:(1Mb RAM 1.2Mb + 40Mb Disk)	£4706.00
Deskpro 386 70:(1Mb RAM 1.2Mb + 70Mb Disk)	£5186.00
Deskpro 386 130: (1 Mb RAM 1.2Mb + 130Mb Disk)	£5989.00

OPTION

40Mb Tape Backup unit	£480.00
-----------------------	---------

All prices include Keyboard, Dual-Mode Monitor & DOS

PRINTERS

All prices include cable

Dot Matrix			
Epson FX800:(240cps, 35cps NLQ, 80col)	£444.00		
Epson FX1000:(240cps, 35cps NLQ, 132col)	£453.00		
Epson LQ1000:(180cps, 60cps NLQ, 132col)	£681.00		
NEC P660:(180cps, 72cps NLQ, 80col)	£410.00		
NEC P760:(180cps, 72cps NLQ, 136col)	£490.00		
NEC P565XL:(264cps, 88cps LQ, 136col)	£885.00		
Toshiba P351	£856.00		

Letter Quality

NEC Spinwriter 8850:(55cps)	£899.00
IBM Quietwriter Model 1	£858.00
IBM Quietwriter Model 2	£1075.00
IBM Quietwriter Model 3	£925.00
HP Laserjet (8ppm)	£1496.00
HP Laserjet Plus (8ppm + graphics)	£2200.00
HP Laser Series II, 512K	£1995.00

Plotters HP 7440A:(A4)	£776.00	HP 7475A:(A3)	£1366.00
-------------------------------	---------	---------------	----------

SOFTWARE

Multimate Advantage	£346.00	Dbase III Plus	£399.00
Wordstar Professional	£290.00	Smart	£486.00
Displaywrite III	£322.00	Symphony	£355.00
Lotus 1-2-3	£247.00	Paradox	£430.00
SuperCalc IV	£230.00	Microsoft Mouse	£140.00

Other Printers, Multifunction Cards & Software available.

EX-RENTAL EQUIPMENT

Please telephone Steven on (0923) 53933 ext 2550 for information and prices on current stock.

SPECIAL OFFERS

Princeton colour monitor 12"	£352.00	Hercules Mono Plus graphic card	£199.00	AST SixPac 384k	£418.00
Princeton EGA monitor 12"	£395.00	Mountain Hardcard 20Mb	£620.00	QUAD EGA (short)	£229.00
Paradise AutoSwitch EGA	£279.00	AST Rampage 512k for AT	£428.00		

Please ring for an immediate response and the latest prices

Prices exclude VAT & Delivery

ALL MAJOR CREDIT CARDS ACCEPTED

All prices are subject to C.W.O.



BY MIKE LEWIS

GETTING TO GRIPS WITH GREP

FOR STRING SEARCHING UNIX HAS THE POWERFUL GREP PROGRAM. NOW THERE IS ALSO AN EQUIVALENT UTILITY THAT RUNS UNDER DOS.

Most micro users know that their word processor's Find and Replace function — and its equivalent in other software — can be a great productivity booster. I use it all the time to correct persistent spelling mistakes, expand abbreviations, and make other global changes to a file of text. But people migrating down from mainframes and minis often find this feature surprisingly primitive compared to the more powerful versions they are used to. Unix folk in particular are disappointed not to find anything equivalent to the Grep utility.

In Unix, searching a file for a given piece of text is a far more elevated affair. It is based on the powerful concept of regular expressions, which with a little ingenuity and imagination can be made to do things that would otherwise be impossible without recourse to programming. Given the undoubted usefulness of regular expressions, it is surprising that they are only just beginning to appear in PC software.

At heart, a regular expression is simply a string of characters that you wish to search for. You might come across it in a text editor or database, where it would form the target for a Find command, or in a program like Grep which searches any number of files for each occurrence of the string.

But the real power of a regular expression derives from the fact that, as well as ordinary characters, it can also contain operators. There are three basic operators. The simplest is concatenation, which simply means that if two characters are adjacent in the expression, the same two characters must be adjacent in the text. Thus the expression `Soft` would match each instance of the string "soft" in the text.

The second operator is alternation. It is similar to an Or operator, and is usually indicated by a vertical bar. So

`H|AT`

would match either "hit" or "hat". The terms on which the operators work can themselves be regular expressions, with parentheses used for grouping. For example,

`(soft)|(software)`

would match either "soft" or "software." As with arithmetic expressions, the parentheses have the effect of changing the precedence. Leaving them out in this example would be equivalent to writing

`soft(t)ssoftware`

Thirdly, there is the closure operator, usually represented by an asterisk. Its purpose is to allow a pattern to be repeated an arbitrary number of times, including zero.

So `AB*A` matches either `AA`, or `A` followed by any number of `B`s followed by another `A`. Unix provides two special cases of the closure: `a +` matches one or more occurrence, and `a ?` matches zero or one occurrence. The expression

`soft(ware)?`

would therefore be another way of searching for either `soft` or `software`.

Another Unix speciality is the character class, denoted by square brackets. These brackets can contain either a list of characters or a range. So

`B[AOU]RN`

would match "barn", "born" and "burn", while

`[A-Za-z]`

would match any letter. A circumflex has the effect of negating the class:

`Chapter[!0-9]`

would match the word "chapter" followed by anything except a digit.

More features of regular expressions are listed in the box. For really useful work, they can be combined in many interesting ways. For example, the expression

`(^*)(&&)`

could be applied to a dBase III program file to locate all comments, these being either lines beginning with an asterisk or those containing a double ampersand. Another example

`[0-9][0-9]$`

would find any line containing a two-digit number and nothing else.

In Unix, regular expressions seem to crop up all the time. Their main application is in the Grep family of utilities, which can search files for a target expression, outputting either the matching lines, the non-matching lines, a count of the matching lines or just the names of the files. So far, very little of

this has percolated down to the world of MS-DOS and the IBM PC. The best implementation I know of regular expressions on the PC is in a program called RPL, which is part of the Turbo Power Programmers' Utilities. It is available, priced at £85, from In Touch, Fairfield House, Brynhyfryd, Caerphilly, Mid-Glamorgan CF8 2QQ; telephone (0222) 882334.

Turbo Power is an extremely useful package. Although it is mainly aimed at Turbo Pascal programmers, many of its functions, including RPL, will appeal to a wider audience. No programming knowledge is needed to use them. It includes a powerful directory lister, a difference finder and a tool for automating operations across sub-directories. It also has a Pascal pretty printer, a structure analyser and an execution profiler.

RPL's implementation of regular expressions goes further than Unix's. The main differences are shown in the table below. Unlike Grep, it also allows for the replacement of expressions, or parts of them, by other expressions. To achieve this, you use braces to delimit the part of the expression that is to be replaced. This is called a tag, and you can have up to nine tags in one expression.

As a simple example, the expression

`~{(Chapter)|(Section)}\s[0-9]`

would find any line containing "chapter" or "section" as the first word, followed by one space and a digit. The word Chapter or Section is tagged, so it is eligible for substitution by whatever is specified in the replacement expression.

Each tag can have a corresponding replacement expression. The simplest consists of a Backslash followed by the tag number: this would cause only the tagged

OPERATORS FOR REGULAR EXPRESSIONS

Unix	RPL	
		Concatenation; no symbol. Matches two adjacent characters
	#	Alternation. Matches term on either side
*	*	Closure. Matches 0 or more occurrences of preceding term
	?	Matches any single character except Newline
*	?*	Matches 0 or more occurrences of any character
+	+	Matches 1 or more occurrences of preceding term
?	!	Matches 0 or 1 occurrence of preceding term
^	^	Matches the start of a line
\$	\$	Matches the end of a line
[]	[]	Delimits a character class
[^]	[^]	Delimits a negative character class
\	\	Interprets next character literally
	{ }	Delimits a tag; RPL only
	\s	Matches a space; RPL only. Similarly, \t is Tab, \n is Newline, etc.

text to be output, all other characters in the selected lines being dropped. Another simple replacement expression is \z, which converts the tag to a null string, thus causing the specified text to be deleted.

However, RPL's regular expressions can get vastly more complicated than this. In fact, the system is sufficiently powerful to be regarded as a very concise special-purpose programming language. Programs in this language can be written as command-line parameters to the RPL interpreter, or they can be put into separate files. These files have the extension Pat. They are limited to 255 characters plus comments, but this is more than enough for the sort of applications for which RPL is intended.

A number of Pat files are included with the Turbo Power package, and some further examples are shown in the listing on this page. Without the help of the comments — which are by definition any text that appears after the first line of each file — it would be difficult for a casual reader to work out what they do. So it is worth taking a closer look at how they work.

Consider for example the following RPL program:

```
-m^{?[+[\s]}\s*-r\1
```

The -m and -r commands introduce the regular expressions for matching and replacing respectively. The match expression

RPL ROUTINES

RMBLKS.PAT

```
-m ^[\s\t]*{?*[\s\t]}[\s\t]*# -r \1  
(strip all leading and trailing blanks and tabs)
```

ONESPACE.PAT

```
-m {[^\s]*\s}\s* -r \1  
(convert multiple spaces between words to single spaces)
```

PDESCR.PAT

```
-i -m ^\s*(OVERLAY)!\s*(\(-)#(PROCEDURE)#(FUNCTION)#(PROGRAM)  
(list Pascal (sub)program declarations, and comment lines that  
start with {-  
-i means ignore case)
```

ADDWRITE.PAT

```
-m (^{?*[\s]}?*)#(^$) -r WriteLn('\1');  
(convert a text file to a series of Pascal WriteLn statements)
```

works like this: start at the beginning of a line (^); match one or more instance of any character (?+); match exactly one instance of any non-space character ([^\s]); and match any or all spaces (\s*).

The result of all this is simply to select for output all lines except those that are empty or contain only spaces. However, the presence of the braces means that all the text in the selected lines, with the exception of any trailing spaces, is tagged. The replace string consists of the tagged text. You end up with a very short program for removing empty lines and trailing spaces from any text file.

It only remains to tell the program the

names of its input and output files. RPL is a filter, so input and output are specified by I/O redirection. If the above program was held in a file named Strip.Pat, it would be run with a command something like:

```
rpl -f strip <oldfile> newfile
```

where the -f option indicates the name of the Pat file.

The snag with utilities like Grep and RPL is that they are batch-orientated. They are designed to work with entire files or sets of files, without user intervention. It would be much more useful if somebody would incorporate the concept of regular expressions in an interactive environment such as a word processor or database. Any offers? PK

MIR MICRO-RENT

MICRO-RENT DO MORE!

MAC-PLUS



TANDON



H-P LASERJET

£58 PER WEEK*

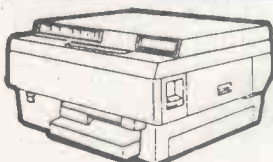

IBM PC AT



Micro-Rent do more than offer you the best rental deals on microcomputers. They rent printers, hard-disk systems, monitors—even some software!

Micro-Rent – the complete rental service – saves you time and money, and solves your problems fast.

Buying? Ex-rental machines often available at reduced prices.

AND NOW – FAX MACHINE RENTAL FROM £40 PER WEEK!

Ring for details

01-700 4848



St. Marks Studios, Chillingworth Road, London, N7

APPLE · APRICOT · IBM PC & XT · OLIVETTI
MACINTOSH · TANDON · SIRIUS · COMPAQ
LASER PRINTERS · DESK-TOP PUBLISHING

*Prices quoted are based on 3-month rental, excluding VAT.

SINGLE PAGE ISN'T BIG ENOUGH TO SHOW ADVANTAGES OF TAXAN'S VIKING 1 MONITOR.

ACTUALLY, IT WOULD TAKE A DOUBLE PAGE SPREAD TO GIVE YOU THE WHOLE PICTURE. THAT'S BECAUSE WITH VIKING 1'S 19" ULTRA-HIGH RESOLUTION MONOCHROME MONITOR YOU CAN NOW DISPLAY TWO FACING PAGES OF TEXT AND GRAPHICS. AND IF YOU USE LOTUS 1-2-3™ AND SYMPHONY™ YOU CAN VIEW SIX TIMES AS MUCH DATA AT ONCE. VIKING 1'S 1280 x 960 DISPLAY RESOLUTION IS REFRESHED AT 66Hz, TO GIVE YOU A STEADY, FLICKER FREE IMAGE. WHICH MEANS, IF YOU'RE A CAD/CAM USER YOU CAN ENJOY THE SORT OF PIN-SHARP IMAGE YOU'D EXPECT FROM DEDICATED ENGINEERING WORK STATIONS. AND BY USING HITACHI'S POWERFUL ACRTC HD 63484™ CONTROLLER CHIP, VIKING 1 OFFERS STUNNINGLY FAST DRAWING SPEEDS. SO IF YOU'RE TIRED OF WORKING IN CRAMPED CONDITIONS, TAKE A LOOK AT VIKING 1. YOU'LL NEVER DO THINGS BY HALVES AGAIN.

TAXAN
PERFECTING THE IMAGE

TO FIND OUT MORE ABOUT THE TAXAN RANGE OF PRODUCTS, CALL US ON 0544 484646.

TAXAN VIKING 1

C O N T A C T

Communications Software for IBM PCs and compatibles

Prestel and Telecom Gold

You will have heard of Contact and will know that it gives simple and trouble free access to the world of information and data communication. Contact allows access to Prestel, Telecom Gold, and many other electronic mail systems, as well as providing a micro to mainframe link. However, you may not be aware of just how powerful and easy to use it is. So here are a few of its features in more detail:

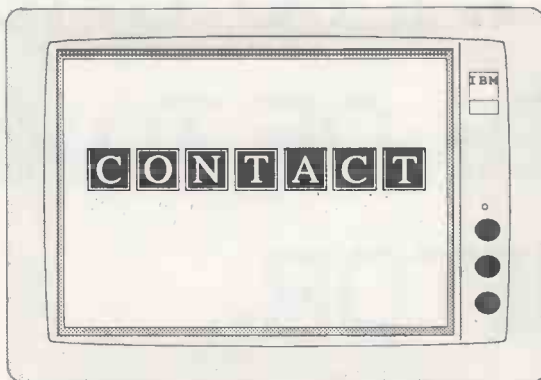

escape sequences removed so you get a text file that really can be edited by your word processor or fed into your database.

Programmable Function Keys

The menus can be pulled down with a mouse or by pressing function keys. In addition you can program each of the 10 function keys with a sequence of commands. For example you could set F5 to contain "Mail Scan Unread" or, for Prestel, F5 could contain *72195# to

Automatic Sequences

With Contact we provide powerful Automatic Sequences to enable your computer to automatically login to Telecom Gold (or One to One, Link7500 etc.) collect your mail and logoff. It can then print the mail out, properly paginated, at any time of the day or night you choose. Of course you can easily write your own sequences too.

take you straight into "Datasearch". Not only can each function key contain up to 80 characters but all 10 can be automatically set up for each of the unlimited number of different services you may want to contact.

VT100 and Viewdata

Contact offers both a high quality VT100 emulation and a full screen Viewdata display. For those with Amstrad PC1512s or IBM PCs with an EGA card the display is in full colour. The VT100 emulation is extensive. With VT100 you can move away from scrolling screens - giving much faster screen update. Files can be captured to disk with all the

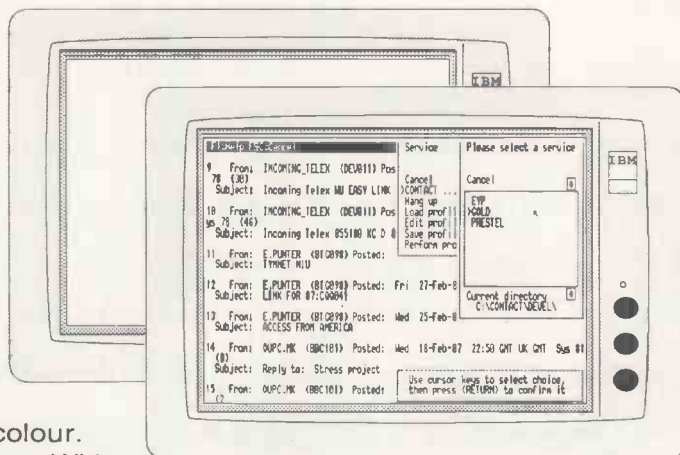

And the price? £79.95

Contact costs £79.95 and is available in two versions: one for the IBM PC and compatibles and the other for the Amstrad PC1512. To place your order or request more information please complete the coupon below and return it to:



X-ON Software Ltd
65 Victoria Road
London N22 4XA
Telephone 01 881 3659

→ circle 140 on enquiry card ←

- Please send me Contact for IBM PC or compatibles
 Please send me Contact for Amstrad PC 1512
 Please send me more information about Contact

I wish to pay by cheque / postal order / Access
 Please debit my Access account with the amount
 of £79.95 - My Access number is

--	--	--	--	--	--	--	--	--	--

Signature _____

Name _____
 (as on Access card)

Address _____

Telephone _____

Pract. 2



COMMS LINK

BY JACK SCHOFIELD

GOLD GROWS UP

AS TELECOM GOLD ATTRACTS MORE USERS IT IS ALSO ACQUIRING NEW SERVICES AND IMPROVED METHODS OF ACCESS

Five years old in April, and Telecom Gold is still growing fast, both in the number of users and the facilities it offers. When you read this, the number of UK users should be around 80,000 and the number on the Dialcom system worldwide will be over 250,000. Italy is now up and running, Finland has just signed up for the system, and Dialcom itself — the US-based parent company bought by British Telecom from ITT last year — has moved to a smart new corporate headquarters in Rockville, Maryland.

The many new users are probably less committed than the pioneers, and will need better documentation than those of us who started even two or three years ago. Help is here in a new booklet by Surya, called *Electronic Mail — A Guide for Humans*. New Info files are going up, and Telecom Gold is in the process of producing a series of small prompt cards which give guidelines on how to use the system. These cards are similar to those already issued for World Reporter and the Official Airline Guide. Also, a new issue of the Dialcom software is having its last bugs fixed.

Among the new databases, Justis is now available from the Network for Law group, while for educational users there is a gateway to the Open University's ECCTIS from system 01, The Times Network Systems (TTNS). Last year TTNS was very successful with helping people find places in polytechnics via its PCAS admissions database; this year the universities will be joining in with UCCA data. In fact, the entire higher-education admissions procedure could be run via Telecom Gold.

Of course, there are still millions of people without electronic mailboxes. But they can still communicate with the in crowd, as long as they have access to a telex machine. The growth of this traffic was revealed in May when Monodata, Telecom Gold's telex bureau, lifted a glass of champagne to celebrate the 500,000th telex routed automatically into a Gold mailbox. The reason why people pay vast sums to send text in capital letters at 50 baud when they could send proper text at 1,200 baud for a lot less money escapes me for the moment. However, should you want to use this facility, send your telexes to 265451 or 265871 Monref G and include the mailbox number in the first line of your text. The software does the rest.

Communicating via Gold from abroad is a problem I have moaned about, but now a Swiss company called Comco has come up



The Comco reader and smart card.

with a solution in the form of a smart card. The Comco system is based on a small card reader which you must insert between your micro and the modem, so you cannot use it with internal modems. Into this reader you insert the smart card, dial the number, hit a full stop and two Returns, and the system puts you straight through to your Telecom Gold computer.

The Bull CP-8 smart card has 4K of memory which holds the user's codes, specifies the chosen network user address (NUA) and the language for prompts, etc, and carries credit for between 200 and 3,200 call charge units. One unit is 50 Swiss centimes — about 20 pence — which buys one connection or 100 seconds of connect time in Europe. The value of a card can be from about £40 to £640; cards can be reloaded, but must be renewed annually. Of course, you also have to pay the cost of the phone call to the nearest Comco node, which will ideally be a local one.

Comco is currently installing Pads in the phone systems of various national telecoms authorities. So far, it offers nodes in London, Paris, Geneva and Amsterdam. Pads are due imminently in Germany and Hong Kong, with Belgium, Australia, Norway, Canada and the US promised. Comco says a CCITT-standard Pad — that is, a European not a Bell-type American Pad — will be opened in the US this year. Once you have called a Comco Pad, your data is routed straight over the international X-25 packet-switched network to the address specified on the card.

There are obvious advantages to this system for European travellers. There is no need to go through the hassle of getting a temporary ID for the local data network, and you do not have to use a long-distance voice line to call London. There is no need to worry about money, as the card is pre-paid. You do not have to learn how to use unfamiliar networks, or try to follow prompts

in a foreign language. You can use the same reader and card in several countries, and even if Comco does not have a Pad in the one you are in, there is probably one closer and cheaper than London.

Because all the network connections are made automatically, you can even send ham-fisted Luddites out with a portable micro and a Comco system, with every expectation that they will be able to log on to their mailbox. If problems do occur, there is on-line help available from a computer located at the head office in Switzerland.

There are also a few drawbacks. First you have to pay a fair amount up front: £295 for the reader and £52 for a basic card. Secondly, it really requires the use of a 300 baud acoustic coupler with your lap portable, though this is probably the most realistic option anyway. Thirdly, each card will only call one NUA: so if I wanted to call one of the *Guardian's* GUA boxes on Sys 79 as well as my own JNL box on Sys 83, I would have to get two cards to do it. Admittedly this is not likely to be a problem for most people; businesses tend to have multiple boxes on the same system.

Fourthly and last, the Comco card reader is yet another thing to carry around. As someone who is in frequent danger of tipping sideways from the combined weight of lap-portable micro, coupler, tape, notebooks, camera and lenses, etc., this is something I could do without. Ideally, the reader should be built into a lap-portable micro like the Tandy 102, also allowing you to use the built-in modem either directly or via acoustic cups. Of course, the major problem with ideal solutions is that no one ever wants to pay for them.

Comco's UK agent is Ben Woolf, who is on Telecom Gold 81:BSD001; telephone 01-387 7792. You can also contact the Comco head office direct on Telecom Gold 84:TXT047; telephone (010 41 21) 365105.

On the whole the Comco smart card system should be of value to regular travellers, or to businesses with less frequent travellers who can share an outfit. The system might also be used for access to databases — but see my article in the March issue for the problems involved. There are several databases I would like to use infrequently, without having to pay dozens of small bills in foreign currencies. But it ought to be possible to use a single pre-payment card like the Comco system — or something similar — to access several databases via a menu, with all the ID and prompt problems taken care of. Worth a thought? 

TOP 20 DESK TOP PUBLISHING SYSTEMS AT TOP 20 PRICES

	RETAIL	OUR PRICE
DTP COMPLETE SYSTEMS		
AMSTRAD PC1512 10MB MONO COMPUTER SENTRONICS LASER PRINTER VENTURA SOFTWARE	3889	3258
MACKINTOSH 512K COMPUTER LASER WRITER PRINTER PAGEMAKER SOFTWARE	7490	5995
IBM PCXT OR COMPATIBLE TURBO SYSTEM ADD ON		
CANON CX + 2MB LASER CARD 1.25MB VENTURA SOFTWARE	3734	2864
LASER PRINTERS		
CANON A1 + 2MB LASER CARD	2939	2195
CANON LB8-8 All	3850	2795
CANON SERIES 2	2195	1795
HP LASER JET PLUS	3518	2749
HP LASER SERIES II	2618	2395
AST TURBO LASER	4150	2995
QMS PS-800 + POSTSCRIPT	4500	3378
KYOCERA F-1010	3395	2795
IMAGE SCANNERS		
CANON IX-12	1100	899
DTP SOFTWARE		
PAGEMAKER MAC & IBM	595	P.O.A.
MAC AUTHOR	199	169
MAC RAGTIME	299	239
MAC PUBLISHER II	175	136
MAC READY SET GO	169	149
XEROX VENTURA IBM	795	669

Prices shown exclude post and packing and VAT and are correct at time of printing.

WHY PAY MORE?

- Call us for our famous eye-testing Price List with over 2,000 items inc: Apple, IBM, Apricot, Epsom software and hardware, printers, monitors, disks. All at great savings.
- Fast delivery.
- Quantity discounts.
- Credit accounts for PLC companies, government depts, hospitals, local authorities, schools, colleges, universities.
- Export a speciality.
- Supplies to many of the World's business computer users.

AC. INTERACTIVE

FREEPOST, LEAMINGTON SPA, WARWICKSHIRE
CV32 5HH, ENGLAND

0926-313345



ROTHERHAM COMPUTER CENTRE.

0709-369912
(2 lines)

AMSTRAD ACORN MICROVITEC
AKHTER SBC BONDWELL STAR
MITSUBISHI CUMNA CITIZEN

AMSTRAD OFFER

FREE 120D CITIZEN PRINTER
with every PC1512, 20Mb Mono
Monitor **£1,033.00**

NEW! SBC

SBC FD, 640K Ram, 4.77/8MHz, Twin
5 1/4 floppy, 4 exp slots, Mono monitor, 1
year free-on-site maintenance **£599.00**

Prices exclusive of VAT.

Education and Business enquiries
contact John or Tony.

ROTHERHAM COMPUTER CENTRE.
135, Wellgate, Rotherham, S60 2NN.
Tel. 0709 369912 (2 lines)

→ circle 143 on enquiry card ←

◆ DIAMOND COMPUTERS

01-445 4456 (4 lines)

◆ Supply of Systems and Peripherals

Tandon

VICTOR

NorthStar

Opus.

AMSTRAD PC1512

- ◆ On-site maintenance available for your PC's and Peripherals. Phone for quotations.
- ◆ Training available in our newly equipped training centre. Individual and company courses.
- ◆ Multiuser and Network Solutions.
- ◆ Industrial and Commercial Applications.
- ◆ Bespoke Software Developments.

"We have the expertise to look
after you."

Diamond Computers Ltd
1390 High Road, Whetstone
London N20 9BH
01-445 4456

→ circle 144 on enquiry card ←

→ circle 142 on enquiry card ←



• C H I P - C H A T •

BY RAY COLES

A MAD, MAD SEMICONDUCTOR WORLD

JAPANESE MANUFACTURERS' ENTHUSIASM FOR PRODUCING THEIR OWN CHIPS COULD RESULT IN HEAVY U.S. TARIFFS THAT COULD SEVERELY AFFECT BOTH US AND UK COMPANIES.

Happy times have returned to Silicon Valley, according to Gordon Moore, Chairman of Intel, who has just reported the company's first quarterly profit since 1985. Yes, the roller-coaster fortunes of the semiconductor industry are about to go into boom mode again, following a three-year bust period which has been blamed largely on over-optimism about the world's appetite for personal computers.

The world, it seems, has now caught up with the optimistic forecasts of 1984, and has started to trade in its eight-bit micro-computers and first-generation PCs for the delights of high-resolution graphics, 32-bit processors and laser printers. The semiconductor industry's prime indicator of health is the so-called "book-to-bill" ratio, which describes the trend in order intake compared with current shipments. It is now climbing well above unity, and those California smiles are gleaming again.

But hang on — what's this? A fair percentage of those new orders now pouring into US chip manufacturers are coming from — can this be true? — Japan. Japanese electronic-equipment manufacturers have suddenly become determined to buy all their semiconductors in the US instead of making their own, or buying only from other Japanese companies. It seems that these Japanese chaps will play cricket if only we explain the rules. Now everybody is happy and fair play has triumphed once again. Perhaps they would buy some British chips if we asked them nicely.

But what innocents we are when it comes to world trade. The canny Japanese are, of course, bent on dominating world markets in as many commodities as possible: cars, watches, cameras, televisions, photocopiers, computers and semiconductors. Fair enough, there is no law against that. Unfortunately, a few local difficulties were caused when the US realised that its semiconductor-manufacturing industry was about to go down the tubes.

The US semiconductor industry put pressure on the US government to do something and gave dire warnings of approaching military impotence if this vital US industry were allowed to fail. The Japanese were accused of dumping memory and micro-processor devices on the US market at prices which were well below cost. This was a justified accusation, but the situation could well have become self-correcting when the Japanese suppliers eventually grew tired of subsidising US equipment manufacturers.

A gung-ho response was called for, how-

ever, and the tough US negotiators eventually persuaded the Japanese government to prevail upon Japanese companies to raise their prices. One result of this was that Japanese semiconductor companies became more profitable and were assured of continued existence. Another was that the profits of US equipment manufacturers slumped as they became less competitive against cheaper, imported Japanese equipment.

The higher margins also made it economically viable for the Japanese to sell their cheaper chips to third parties, who could then sell them on to the US at a shade under the official rate, or build them into cheap equipment to sell there.

The agreement which triggered all this off, the US-Japanese Semiconductor Trade Pact, was signed in the summer of 1986 and has been a dismal failure. In January, for example, Japan's shipments of semiconductors were up by 46 percent compared with the previous year. Shipments to the US were up by only 11 percent — a modest increase — but sales to other Asian countries were up by a massive 114 percent. There are no prizes for guessing where most of those devices ended up.

In the US, equipment manufacturers are incensed. The agreement has effectively established a cartel, setting prices that are artificially higher than what the market would normally pay. Japanese companies are reaping windfall profits from US buyers and are still able to dump their surpluses on other countries. These equipment manufacturers may soon be forced to move their manufacturing operations to other countries, to take advantage of the cheap chips now denied them in the US. Unfortunately, the agreement did nothing to reduce the overproduction in Japan which is at the heart of the problem.

Clearly, gentlemanly agreements were not going to work and so dirty tricks were considered. You may remember the French managed to wring useful concessions from the Japanese when faced with a flood of Japanese video recorders. They simply instituted a regulation which required all video recorders, regardless of origin, to be imported through the single tiny customs establishment at Poitiers. For some unfathomable reason, they forgot to increase the customs staff at Poitiers, with the result that the influx of Japanese videos was reduced to a trickle.

No doubt the US rejected this ploy because their equipment manufacturers

actually rely on being able to use Japanese chips. Drastic action was called for, however, and so the ultimate sanction of trade tariffs was invoked. If the Japanese do not mend their ways — by reducing manufacturing capacity and by starting to use more US chips, for example — then the US intends to impose \$300 million of tariffs on Japanese electronic equipment — not chips — that it imports.

Shortly after the US announcement, the Japanese Ministry of International Trade and Industry (MITI) started to crack down on Japanese semiconductor manufacturers. MITI has set production quotas for Japanese plants, both in Japan and overseas, and has decreed that export licences are now required for all semiconductor shipments worth more than a few pounds. Finally, and perhaps most significantly, MITI has prevailed upon Japanese semiconductor users to buy all the devices they can from the US. Being a well-disciplined crowd, the equipment manufacturers have responded magnificently, placing huge orders with US chip suppliers, pushing up the book-to-bill ratio.

But I have a feeling that very few of those semiconductor orders now being placed with the US will ever result in actual sales. The idea is to show how willing Japan is to cooperate, so that anyone continuing to talk of tariffs is obviously a bit of a bad egg. Once the US relents, I would be surprised if those orders did not melt away.

But suppose the US sticks to its guns and does apply the tariffs? Already hundreds of US manufacturers who have come to rely on Japanese chips are feeling the pinch. Even the mighty Digital Equipment (DEC) has reported that it has a shortage of one-third of a million DRAM chips.

Protests are also likely from the the UK, where Japanese chip-fabrication plants have been established. The quotas applied by MITI apply to them too and I suppose layoffs might be the result. Texas Instruments has taken the fight to Japan's doorstep by building factories there, so it too will now be restricted by quotas, and it will no doubt be adding to the growing chorus of complaints against the US tariff action.

Encouraged by the strong US action, we Brits have now joined in with a spirited complaint about the discrimination against Cable and Wireless in the Japanese telecommunications market. Sanctions against Japanese banking interests have been threatened and the City is terrified of potential Japanese reprisals. It must be spring!

PC

One good idea leads to another.



The Macintosh Plus



The Macintosh SE

— circle 135 on enquiry card —

And another.

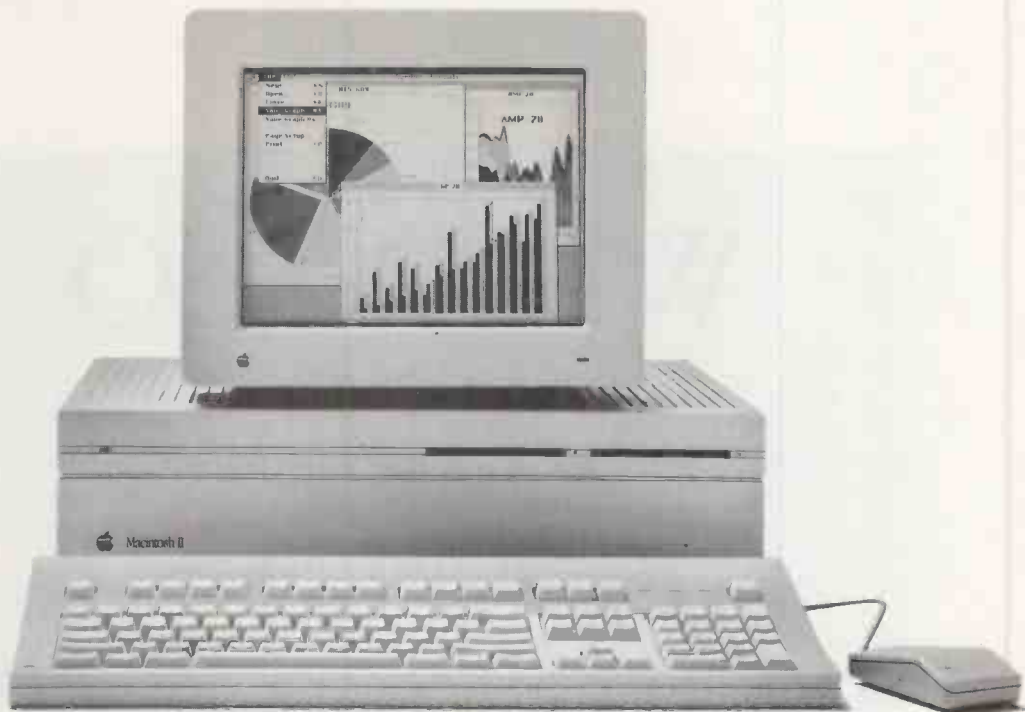

The Macintosh II

In 1984, Apple introduced the Macintosh™. A computer based on the idea that people shouldn't have to work the way computers work. Computers should work the way people work.

In 1986, the introduction of the Macintosh Plus established Macintosh as the new standard in personal computing.

Which of course led to yet another great idea.

The Macintosh SE. The next step in the Macintosh evolution.

The Macintosh SE combines the same intuitive graphic interface of the Macintosh Plus with many of the technological enhancements corporate customers have been asking for.

Like a second 800K internal drive.

Or a built-in 20 megabyte hard disk with a single 800K internal drive.

The Macintosh SE comes with a full megabyte of internal memory that can be expanded to four megabytes.

There's an expansion slot to customise the Macintosh SE to your specific needs.

So you can add a card for a disk drive that lets you work with documents created on an IBM or IBM compatible PC. Or a card that enables your Macintosh SE to communicate through non-Apple networks to host mainframes.

Of course, the Macintosh SE runs all your Macintosh programs. Only faster. And, because it's a Macintosh, you'll never have to become a computer expert to use it.

In addition to the Macintosh SE, Apple proudly introduces the Macintosh II.

A computer so powerful and so flexible it challenges the very definition of what a personal computer can be. And do.

Inside the Macintosh II resides a new microprocessor. The Motorola 68020.

Which takes you through virtually every Macintosh program at four times the speed of a Macintosh Plus.

The Macintosh II also boasts a new coprocessor which enables it to perform mathematical calculations at two hundred times the speed of the Macintosh Plus.

But the biggest news is the Macintosh II's open architecture, with six expansion slots that allow you to customise your Macintosh to serve virtually any function you can imagine.

Internally, the Macintosh II offers you more memory options than a politician. From one to eight megabytes.

And although our internal forty megabyte hard drive is probably sufficient storage for most users, you can employ an internal drive of up to eighty megabytes.

The Macintosh II offers you a choice of viewpoints. A thirteen inch colour monitor or a twelve inch black and white.

Today, the Macintosh II will satisfy the needs of the most power hungry business user, scientist or engineer.

Tomorrow, it will also lead the way into startling new technologies. After all, one good idea inevitably leads to another.

Please send me more information about the new Macintosh range. Post to: Apple Computer (UK) Ltd., FREEPOST, Information Centre, Eastman Way, Hemel Hempstead, Herts. HP2 4BR or dial 100 and ask for Freephone Apple.

NAME	TITLE
COMPANY	
ADDRESS	
POSTCODE	TEL. NO.
	PC7

Apple™. The power to succeed.



©1987 Apple Computer, Inc. Apple, the Apple Logo and Macintosh are trademarks of Apple Computer, Inc. IBM is a registered trademark of International Business Machines Corp.

ADVANCED
DESIGN

WHAT'S SO
SPECIAL
ABOUT THE
WORLD'S MOST
ADVANCED
DESK-TOP
COMPUTER?

£2,999

X E N : H I G H P E R F O R M A N

IBM, Microsoft, Xenix, MUMPS, BOS, PICK, Concurrent DOS, Lotus 1-2-3 and Intel are all registered trade marks of their respective operating companies.

Introducing the remarkable new Apricot XEN-i 386. Quite simply, it is the most advanced desk top computer in the world.

As Which PC so aptly puts it, . . . "specifications which knock the socks off" . . .

Here's why: it will run any of your existing software ten times faster than an IBM PC.

At this kind of speed, even the latest crop of 286 machines cannot come close. Especially with the forthcoming 386 O/S 2 operating system which will enable sixteen different applications to run concurrently.

And the unique skills of Apricot have further enhanced the already staggering performance of the Intel 32-bit processor.

At a glance, the specifications alone can be seen to be rather special.

4 MIPS processor-speed; up to 25 Ms hard-disk access time (with a choice of 30 or 45 Mbyte storage); up to 16 Mbyte RAM; full IBM compatibility; and powerful multi-tasking software.

In addition, it gives the choice of either 5¼" standard floppies, or the new 3½" high-capacity drives.

So any current compatible software can be used to the full. But far faster than ever before.

And it will work together with all existing 'IBM-standard' monitors, cards and peripherals.

More importantly, it opens the door to the dazzling performance that the next generation of 386-based software will bring.

However, this XEN-i is also special in other ways.

Because XEN is unique in being the world's only computer system that can

be upgraded to the level of the most powerful.

It can become the heart of a major network or multi-user installation: running MS-DOS, Xenix, Concurrent DOS, BOS, PICK, or MUMPS. (As well as working with other computer systems and databases across any distance.)

Or turn it into the most sophisticated world-standard Desk Top Publishing system ever available.

Even the simple addition of the 387 co-processor will add yet another mind-boggling dimension to its processing power.

However, what is most special of all is the price.

By comparison, IBM will happily charge you over 50% more for their smallest 386 computer.

In fact you still pay 35% more for their equivalent 286-based P.C.!

And in both cases, that is without all the on-board programs that Apricot take the trouble to include.

Such as the powerful Word-Processing with Graphics. Or the Lotus 1-2-3 compatible spreadsheet, VP Planner. As well as all the current MS Win-

dows software, giving you a calculator, clock, card-index, and personal diary.

To quote a recent independent review, the new XEN-i 386 is ". . . one of the most impressive and innovative PC offerings to appear from the UK for some years . . ."

It's available to you now from £2999.*

From over 250 specialist centres around the UK. Just call Freefone Apricot for more details.



 **apricot**

*Excludes monitor, adaptor card, and VAT. System illustrated is the XEN-i386/45 with High Resolution colour monitor.

E C O M P U T I N G S Y S T E M S

Apricot Computers plc, Apricot House, 111, Hagley Road, Edgbaston, Birmingham B16 8LB.

→ circle 139 on enquiry card ←

Add Multi-user Power to your PC



Microport UNIX

Turn your AT into a full UNIX Multi-user system with 'System V/AT'; includes Runtime, C and Fortran Compilers as well as text processing system. £440



The SK Computer Group has been supplying Multi-user solutions nationwide for the past ten years.

Now with the power of 80286 and 80386 systems, SK brings years of multi-user expertise to the PC market.

If your requirement is to support from 2 to 16 users, let SK configure your complete installation or upgrade your current system by adding SK Multi-user Options.

SK offers complete multi-user solutions. We not only offer hardware, software and expert consultancy but also installation services, customer training and after-sales back-up.

SK for added power!

MULTI-USER SOFTWARE

Status

Multi-user, Multi-company Integrated Accounts, comprising Sales, Purchase, Nominal, Sales Order Processing, Stock and Payroll with front end packages for transport companies, hotels and point-of-sale systems.

Informix SQL

The leading relational DBMS for UNIX and PCNET.

Whatever your Multi-user software requirements, SK can offer powerful, cost-effective solutions.

Transnet

The Local Area Network that covers all options. Supports IBM PCNET, Novell Netware and Transnet software. Simple to install, easy to use. Complete starter pack £500. Each additional LAN card £250.



Tall Tree & Bell Memory



Tall Tree systems JRAM3, 2Mb Lotus/Intel/Microsoft expanded memory card. Use with Concurrent XM and DOS. Bell Technologies Ramdisk, 3Mb card with Ramdisk software drivers for UNIX and XENIX.

Bell Technologies Special Capability Tape Products

PC-AT Multi-user tape back-up from the company that invented it. T60I (internal) & T60E (external) tape systems each with 60Mb per cartridge. Comes with Bell's DynaCache software for UNIX and XENIX.



Bell Technologies Hubcard

Add six terminals to your PC-AT with a single card. Comes complete with software drivers for XENIX and UNIX. £365



Kimtron PC Terminal

Full PC screen and keyboard compatible terminal. Use with Concurrent DOS, XENIX and Multi-link. £365



Disk Drives - SK86

Massively increase storage and speed on your AT by adding the SK86. Provides 86Mb with 25ms access time. Available for XENIX, UNIX & DOS. £1495



PC Slave+

ADC's breakthrough in multi-user DOS systems. Provides two full PCs on a card; just add mono monitors and keyboards.

Each user has own CPU and 512K memory. Runs with IBM PCNET.



DEALER ENQUIRIES
WELCOME



SK Micro Systems Limited,
St. Michaels House,
Norton Way South, Letchworth, Herts SG6 1PB
Tel:(0462)679331 Telex:825647 SKSYS G Fax:(0462)682490

Hard hardcopy entry.



Easy hardcopy entry.

**KURZWEIL
COMPUTER
PRODUCTS**
A Xerox Company



Unit 8, Suttons Industrial Park, READING RG6 1AZ
Tel: Reading (0734) 668421

→ circle 120 on enquiry card ←

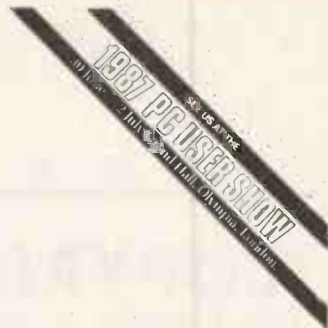

Introducing Kurzweil's *DISCOVER*®!
The only scanning system under £10,000 that lets users enter whole documents—typeset or typewritten text and graphics—directly into their PCs!

Published reports. Correspondence. Technical manuals. Drawings and graphs. *DISCOVER*'s breakthrough technology takes it all in—thanks to Kurzweil's exclusive Artificial Intelligence-based recognition software.

Discover how easy document entry can be. Just enter a command on the PC, then place the document in the feeder. *DISCOVER* does the rest, quickly and automatically, while other work can be done on the PC simultaneously. (That's *another* Kurzweil exclusive.)



**The result:
an exciting
opportunity
to catch the latest wave of desktop
technology.**

For PC users, hardcopy information that's ready whenever and wherever it's needed.

DISCOVER! A whole new world of hardcopy entry. From Kurzweil Computer Products Ltd., a Xerox company.



• L E G A L S T A T E M E N T S •

BY ANNE STAINES

COPYRIGHT AND SOFTWARE CLONES

THE CURRENT COPYRIGHT LAWS APPEAR TO BE IN NEED OF A CHANGE TO PREVENT CLONING. AS THEY STAND, THEY COULD BE DOING MORE HARM THAN GOOD.

There appears to be no end to the controversy over software clones. The United States Supreme Court has recently refused a petition to review by the procedure of certiorari last year's finding by the US Court of Appeals that copyright subsisted in the structure, sequence and organisation (SSO) of computer programs. This decision was controversial, since the computer code of the plaintiff's program had not been reproduced at all.

On normal copyright principles, a literary work has to be substantially reproduced before the defendant can be said to have infringed copyright. For the purposes of copyright law, computer programs have in the past been treated as literary works. But in this case the defendant had written his version in a different language — Basic, as opposed to EDL — and no substantial similarity could be shown between the code of the two programs. Nevertheless, it was held that the screens of the plaintiff's program had been copied, and that this in itself was enough to prove copyright infringement.

At the root of the controversy surrounding this decision are two basic tenets of copyright law. The first of these is that copyright protects original works fixed in a material form; it does not protect ideas. Between the conception of a bright idea and the creation of a copyright work there is, in theory, a lot of hard work. To a large extent it is true to say that the hard work — or in the words of the relevant legislation, the "labour, skill and judgement" — involved at this stage is what distinguishes the idea from the work. A certain amount of effort must go into designing the structure of a program, and one theory being mooted is that the courts are trying to protect the fruits of that expenditure of effort or skill as a work in itself. How much effort, then, is enough?

The second point at issue centres around the fact that copyright works, whether literary or not, are supposed to be artistic rather than functional or utilitarian. Few computer screens would qualify for protection as artistic works in the normal meaning of the phrase. So should they really be getting in through the back door by relying on their SSO?

The US courts are already inundated with claims of infringement based on similarities of program structure, where no copyright

action could be maintained on the basis of reproduction of the code. Copyright in a program is currently held to be infringed if either its SSO or its look and feel are reproduced. Since looking and feeling are essentially subjective activities, each case will have to be decided on a subjective judgement of the similarities of the disputed programs. No clear guidelines can possibly be drawn. The only way of resolving disputes will be through more litigation.

Look and feel are most commonly reproduced by inexpensive clones of popular business applications software. Initial predictions that protecting SSO and look and feel would mean the death of cloning have proved too simplistic. Some clones are, apparently, almost legal. A court in Tallahassee, Florida, recently had to determine whether Softklone's Mirror program infringed copyright in DCA's Crosstalk. It was found that Mirror reproduced the arrangement and design of the Crosstalk status screen and that copyright in that screen had therefore been infringed. Nevertheless, the Mirror program as a whole was held not to infringe the copyright in Crosstalk as a whole. Softklone intends to modify the offending screen and carry on.

There are indications in the Mirror case that the judge wished to restrict the effect of the look and feel line of authority to cases where there is blatant reproduction of a substantial number of screens. That approach falls more easily into line with the principles applicable to copyright in cinematograph films. Computer programs cannot usually qualify as films for copyright purposes since they do not satisfy the statutory requirement that the screens appear as a continuous moving picture.

The real significance of all this is not just the difficulty of applying old rules to new technology. The more fundamental questions are whether these rules are at all appropriate, and whether they may be doing more harm than good. The economic justification for copyright and other intellectual-property laws — such as those protecting patents and trade marks — is that they encourage the creation of new works by giving the creators a monopoly on any financial reward which their work might generate.

But is profit the sole motivation for creativity and inventiveness? Is the long-term

protection granted by copyright the most appropriate tool for profit maximisation? That might successfully be argued of industries such as pharmaceuticals, where the cost of R&D is high and the shelf life of the product in which to recoup these costs is long. It is much less easy to justify that argument in respect of the software industry as a whole.

Although there are some sections of the software industry which depend on lengthy research and development, they are often too specialised to be vulnerable to cloning in any event. The brief shelf life of many of the most cloneable programs make this industry more inclined to pick up the profits fast and move on, rather than sit counting them for 50 years. On the other hand, the advantages to society of greater availability of good, cheap software do not need listing here. The presence of protectionist copyright laws may even discourage inventiveness and creativity in the software industry, by permitting producers to rest on their laurels.

Whichever of these viewpoints is true — and there is probably an element of truth in both — the real cause for concern is that they are not being debated with a view to formulating any sensible policies about the software industry. What does the government want this industry to do? How can regulation help it to achieve these ends?

Any policy documents the government does circulate are invariably contradictory. For example, whereas a discussion paper in 1983 advocated legislation to encourage the creation of small businesses in the computer industry, another in 1986 argued that it was precisely because UK computer companies were comparatively small that they were falling behind in world competitiveness.

The US approach to software protection has been, by contrast, strategic. A Congressional committee debated long and hard before finally recommending the US legislation now in force. One of the strongest arguments put to the Supreme Court against the protection of SSO was that it results in a law bearing no resemblance to that which the Congressional committee thought it had created.

In the US, copyright in any strict sense may no longer govern the issue of software cloning. In Britain it is high time we thought more deeply about whether it should.

PK

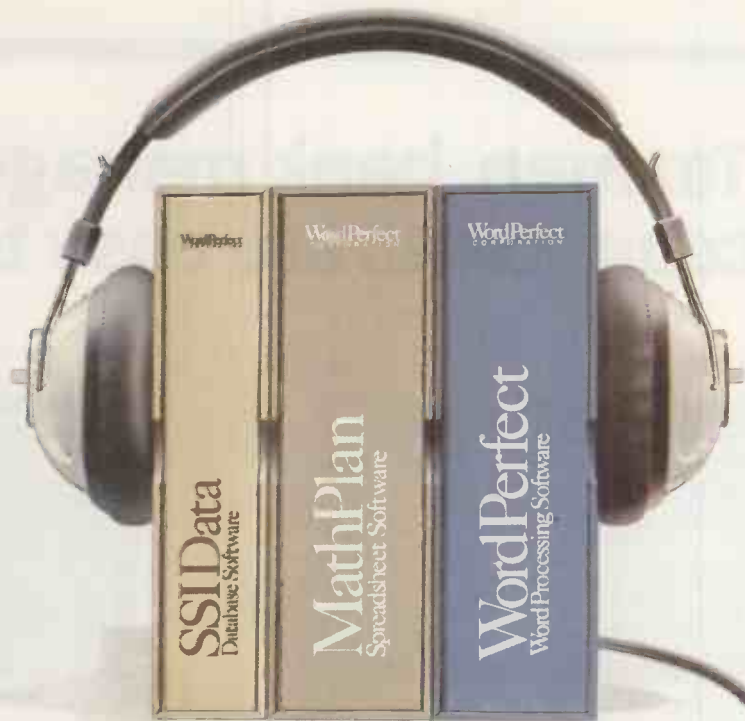

WordPerfect Library. Speaks volumes for software integration.

WordPerfect Library brings new meaning to the subject of software integration by linking three of today's most advanced software packages – WordPerfect, MathPlan and SSIData.

Programs are immediately accessed from the Shell menu by a single key stroke as are the 6 powerful utilities which provide a full function Calculator, Calendar, Notebook, File Manager, Macro and Program Editor.

The movement of text, figures, graphs and records

is simplicity itself within WordPerfect Library, which gives an impressive degree of flexibility, in operation and is simplified by the use of function keys and a colour coded template dispensing with the need for complex control codes. Create your own menu structure, from which you can run DOS commands and batch files.

To improve your knowledge and to find out details of how you too can join the WordPerfect Library, telephone or write to Sentinel Software.



SENTINEL
SOFTWARE

Wellington House, New Zealand Avenue,
Walton on Thames, Surrey KT12 1PY.
Telephone: (0932) 231164
Telex: 916005. FERGUS G.

WordPerfect

Mathplan

SSIData

→ circle 121 on enquiry card ←

Taxmen, bank managers and accountants are easy to defeat.

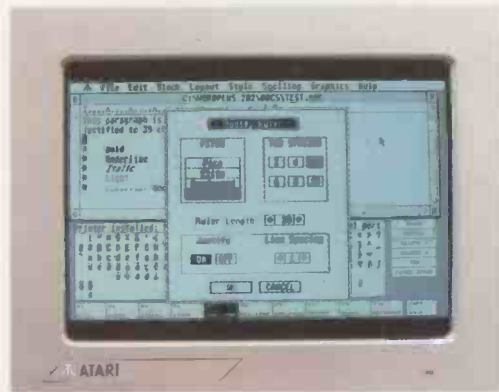

1st Word Plus – G.S.T. Professional word processor featuring U.K. spellings and integration of graphics including 1st Mail for full control of form letters etc



Superbase Personal – Precision Software. All the features of GEM combined with full relational database power. Easy to set up, flexible, plus unique picture index facility.



Fleet Street Publisher – Mirrosoft. The complete desk-top publishing package. Gives you page make-up combining text and graphics for sophisticated, professional looking documents.

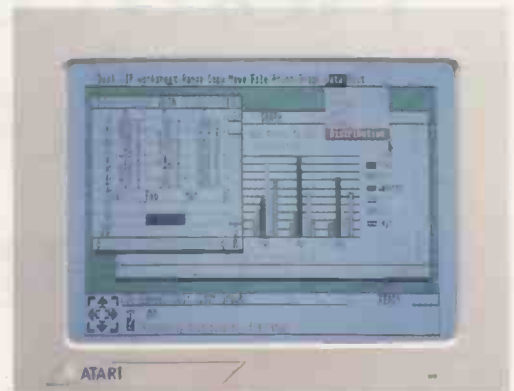

VIP GEM – Silica Distribution. VIP Professional is an integrated spreadsheet, database, and graphics package. GEM environment plus Lotus 1-2-3 compatibility.

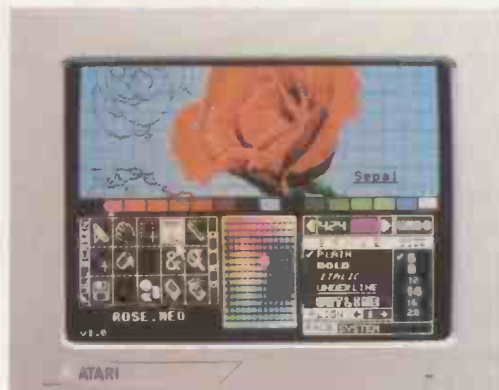

Neochrome – Atari. A powerful, sophisticated painting program for unsurpassed graphics. Work boldly on full screen canvas or in minute detail using Neochrome's magnifier.



Fastcom – Atari. A professional communications software package giving access to most major databases worldwide. (Integrated ASCII/Viewdata package).

These other fiends may be a bit trickier.

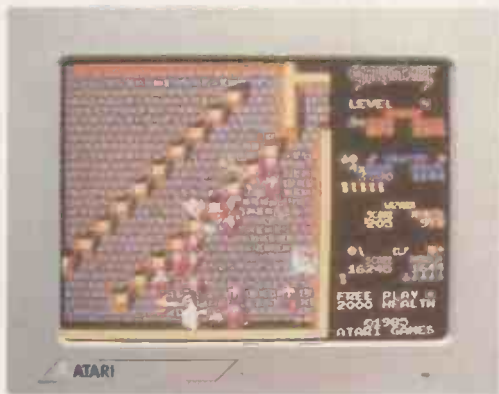

Gauntlet - U.S. Gold. Enter a world of monsters, mazes, mystery and combat in the ultimate role-playing fantasy game.



Tai-Pan - Ocean. Voyage to 19th Century Hong Kong for action and excitement with pirates, smuggling and mutiny.



Metrocross - U.S. Gold! It takes lightning reflexes to get past the potholes, obstacles and forbidden zones to reach the other side. And that's just the beginning!



Arkenoid - Imagine! The latest smash-hit coin-op game! Are your reactions quick enough to handle 33 different play screens?

Mixing business with pleasure is no problem with an Atari 520 ST. Not when you've got over 1,000 software titles to choose from.

You'll find all the latest games and a huge range of business titles from the top business software houses. And the range is growing all the time.

You won't be short of power, either. The Atari 520 ST is twice as powerful as most business micros.

So you'll be able to create spectacular colour graphics. Even animate them to make your own films. If you're musically minded, you can compose and play a full symphony.

Or, for those who'd rather write programs than music, the 520 ST supports over thirty programming languages.

In fact, whatever you're looking for in a computer, you'll find it in the Atari 520 ST.



ATARI 520 ST
WORKS HARD · PLAYS HARD

→ circle 122 on enquiry card ←

*Screenshots are from the original Arcade game.

To help you defeat
the taxman



and destroy the
aliens,

we've massacred
the price.

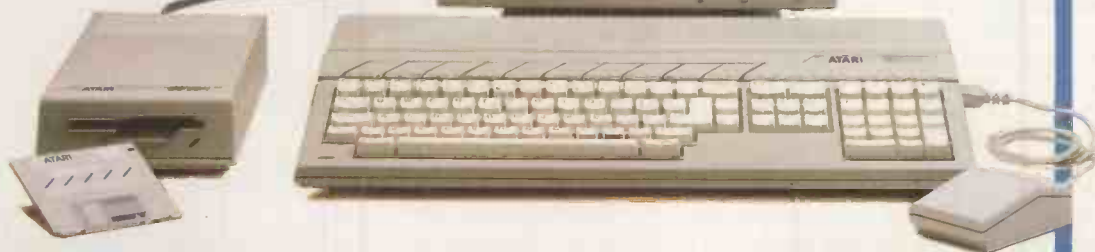

For a limited period, the Atari 520 STM is even more of a knockout than usual.

We're offering it for just £449.95 (inc. VAT) complete with SF354 disk drive, SM125 mono monitor,* a mouse worth £24.95 and 1st Word, worth £49.95.

So as well as saving you from the enemy, the 520 STM will also save you £184. You'd better hurry though, because it won't be long before our stocks are wiped out.

ATARI 520 STM
WORKS HARD · PLAYS HARD

*Offer includes mono monitor. The 520STM plugs into a standard colour T.V.

→ circle 123 on enquiry card ←

ZENITH Z-386

PERFORMANCE AT CLONE

By Steve Malone

On speed alone this AT clone is up with the best, but will compatibility problems prove the downfall of them all?

Undaunted by IBM's pre-emptive strike, the clone manufacturers continue with the flood of 80386-based AT compatibles. While British companies have been circumspect with their products, many of the US-based manufacturers see IBM's divergence from the standard and the late delivery dates as an error they are ready to capitalise on.

The Zenith Z-386 was previewed at the Which Computer? Show in February. It became one of the stars of the show with a tour de force graphics display that was ably assisted by a Turbo-PGA card that Zenith had quietly slipped in. The very same machine was provided by Zenith for review, although sadly the Turbo-PGA had been removed. The review model was fitted with a 1.2 Mbyte floppy-disc drive and a 40Mbyte hard disc.

The machine comes in the hulking three-box format that we have become used to with the AT and its clones. However, the keyboard provided was of the old PC type, with 10 function keys and a combined cursor-control and numeric keypad. Zenith informed us that the production models will come equipped with the new enhanced keyboard, similar to the layout used with later versions of the AT and with the PS/2 range. The AT/E keyboard originally provided with the machine had managed to get broken on its travels.

The enhanced colour monitor provided with the review system will be an optional extra for purchasers. The monitor is unusual in having a switch on the front which allows you to select a white, amber or green display when working in monochrome mode. Although we can understand the reason behind this switch, we found it a bit pointless — and a positive disadvantage if you are using colour.

The front of the main system unit follows the standard AT design. On the left-hand side is a keyboard lock, along with LEDs indicating power and hard-disc activity. On the opposite side is a 1.2Mbyte 5.25in. floppy-disc drive. Adjacent to the floppy there is a plastic slot covering the housing for a second optional disc drive.

On the right-hand side of the machine there is a grille for the transformer fan, and



round the back there are the I/O ports for 10 expansion slots. The keyboard socket is also on the back, as is the power input and an odd 80mm. by 95mm. removable plate. The people at Zenith's UK arm say they have no idea what this panel might be used for, but hinted darkly at the number of machines that Zenith sells to the Pentagon. The military will doubtless be pleased at the robustness of the machine. Six screws have to be

removed before you get inside — two on the back and two on each side.

When we finally got to the guts of the Z-386 it was noticeable how warm it had become in the hour or so we had been running it. The reason behind this was obvious when you took a close look at the architecture. Zenith has adopted a backplane construction, which means that almost all the components have to be installed on



SPECIFICATION

CPU: Intel 80386 running at 16MHz
RAM: 1Mbyte static-column RAM; cache memory fitted to production models
Mass storage: one 5.25in. 1.2Mbyte floppy-disc drive and one 40Mbyte or 80Mbyte hard disc
Interfaces: one RS-232C serial port, one parallel printer port
Display: none with 40Mbyte model; EGA with 80Mbyte model
Price: 40Mbyte version £5,099; 80Mbyte version £5,599
Manufacturer: Zenith Data Systems Corporation of Glenview, Illinois
UK distributor: Zenith Data Systems, St. Johns Court, Easton Street, High Wycombe, Buckinghamshire HP11 1JX. Telephone: (0494) 459266
Available: now

IBM, have taken the opposite tack to Zenith. On their recent machines the I/O and other ports which were formerly housed in expansion slots are fitted to the motherboard. They thus consume less power, and the machines are consequently fitted with lower-power transformers.

The hard disc and floppy disc are both half-height devices. As an AT is half as high again as a PC, this should leave room for a possible six storage systems. Further examination of the inside of the Z-386 confirmed something else we suspected: the metal shield on the front of the outer casing limits you to the two drives in the front, plus hard discs. Most people will be quite happy with this arrangement, but there is a minority of power users who would like a hard disc, two floppies and a tape streamer. This the Z-386 is unable to provide.

Most of the space inside the system box is occupied by the 10 full-length expansion slots. There are two eight-bit slots, two 16-bit slots and six 32-bit slots. In common with those of most other 80386-based AT compatibles, the buses have been rigged to

ZENITH Z-386

VERDICT

	POOR	AVERAGE	GOOD	EXCELLENT
Performance	<input type="checkbox"/>	<input type="checkbox"/>	<input checked="" type="checkbox"/>	<input type="checkbox"/>
Ease of use	<input type="checkbox"/>	<input type="checkbox"/>	<input checked="" type="checkbox"/>	<input type="checkbox"/>
Documentation	<input type="checkbox"/>	<input checked="" type="checkbox"/>	<input type="checkbox"/>	<input type="checkbox"/>
Value for money	<input type="checkbox"/>	<input type="checkbox"/>	<input checked="" type="checkbox"/>	<input type="checkbox"/>

A challenger for the Deskpro 386.

run at different speeds. Thus the eight-bit slots run at 4.77MHz with one wait state; the 16-bit slots run at 8MHz and the 32-bit slots at the full 16MHz, both with no wait states. The necessary duplex circuitry is built on to the motherboard.

Zenith, like other manufacturers, has developed its own architecture for the 32-bit slots. Now that it is apparent there is not going to be an IBM standard to follow, the various compatible manufacturers really ought to get together and set a standard 32-bit bus architecture. The likes of AST and Orchid are not going to want to produce a dozen different versions of the same board just to suit the compatible manufacturers. If they don't hang together on this one, IBM will hang them separately.

In the review machine, five slots were being used. A Paradise EGA card occupied one of the eight-bit slots and the disc-controller board took up a 16-bit slot. Three 32-bit slots were used by daughter cards: the main processor card, a memory card containing 1Mbyte of RAM and an I/O card.

The processor card held the 80386 CPU running at 16MHz along with assorted logic and support chips. On the finished models there will be an option to alter the clock

speed between 16MHz, 8MHz and 4.77MHz by pressing the Ctrl, Alt and Enter keys. There are sockets for both 80387 and 80287 maths co-processors. An interface is also provided for a static-RAM cache memory — something between 32K and 96K will eventually be available.

The second 32-bit card inside the computer is a general-purpose I/O sub-system. It is equipped with the serial and parallel output ports on the outside of the machine as well as the DMA controller and other internal I/O systems. The 1Mbyte of RAM supplied as standard on the Z-386 is fitted on the final 32-bit card. Zenith has followed Compaq's lead in this respect and used static-column RAM to boost performance.

The wisdom of this decision is borne out by the Basic Benchmarks. The Z-386 breezed home in an average time of 1.86 seconds, putting it in second place behind the IBM Model 80 at 1.83 seconds and in front of the Compaq Deskpro 386 at 1.89. Incidentally, by the time you read this, the placings may have changed. Compaq is said to be somewhat miffed at being overtaken by IBM, and is rumoured to be tuning the Deskpro 386 so that it can regain pole position.

The Disc Benchmarks were almost as impressive. The hard disc came home in 32.4 seconds — once again slightly behind the IBM Model 80, but not much. The floppy-disc timing was a respectable 208 seconds. But despite the speed, it was apparent that there was something wrong with the disc setup. On power-up, the machine hung around for a couple of minutes before deigning to read the disc, and even then it came up with an error message. The computer seemed to think that there was an additional floppy-disc drive. We tried using Zenith's Setup and DSKSetup, but none of the facilities provided would persuade the computer to go straight to the hard disc.

This fault seemed to have a follow-through effect on our software trials. When we attempted to load Sidekick, the computer continually generated a disc-read error. The same disc ran on a Deskpro 386 with no problem. On the other hand, Word — a program we had trouble with last month on the Kaypro 386 — booted with no problem. Lotus 1-2-3 worked in CGA mode, although attempting to generate a graph in EGA mode resulted in multi-coloured snow.

CONCLUSIONS

- The Zenith Z-386 is a reasonably priced entrant in the power-user stakes.
- The backplane design requires more power than most machines, but a hefty power-supply unit is built in and we had no problems running the machine.
- Along with the other 80386 AT-compatible manufacturers, Zenith really ought to be formulating an agreed standard for the 32-bit bus.
- The machine is very fast, although not quite as fast as the IBM Model 80. We had trouble with the disc drives, although hopefully this problem will be fixed on the production machines.

expansion slots. The motherboard was almost empty, except for a bit of circuitry grouped around the keyboard socket. To drive all the electronics on the daughterboards Zenith has fitted its computer with a healthy 200 Watt power supply.

It has been impressed upon us recently that a considerable amount of the power is required to run expansion slots. Some other companies, notably Research Machines and

REVIEW

IBM PS/2 MODEL 30 WHO NEEDS IT?

By Glyn Moody

It looks like one of the new IBM family, but beneath the skin this elegant and well-built machine is more like a high-performance upgrade of the original PC.



SPECIFICATION

CPU: 8086 running at 8MHz

RAM: 640K as standard

ROM: 64K BIOS and Basic

Mass storage: two 720K 3.5in. floppy-disc drives, or combination of one 720K floppy and one 20Mbyte hard disc

Keyboard: standard IBM layout with 12 function keys, separate cursor keys and numeric keypad

Display: MCGA resolution offering 630x480 pixels with two colours or two levels of grey; 320x200 pixels with 256 colours or 64 shades of grey; 80x25 characters in 16 colours or grey shades with eight-by-16-pixel character matrix

Software in price: Basic

Hardware expansion: optional 200Mbyte optical disc drive

Size: 406mm. (16in.) x 398mm. (15.6in.) by 101mm. (4in.)

Weight: 7.1kg

Price: £1,106 for twin-floppy Model 30-002; £1,559 for 20Mbyte hard-disc Model 30-021; keyboard £189, monitors from £201, DOS 3.3 £70, mouse £60

Manufacturer: made in the UK by IBM

UK supplier: IBM UK Ltd, National Enquiry Centre, 414 Chiswick High Road, London W4 5TF. Telephone: 01-995 7700

Available: now

Improved graphics, 3.5in. discs and a more stylish appearance set the PS/2 Model 30 apart from its predecessors.



The first thing which needs to be said about the initial release of the new IBM Personal System/2 series is that the Model 30 is not really part of that new generation. True, it uses 3.5in. discs and shares a similar casing, but it lacks the key elements of the Micro Channel and the new graphics standard. Furthermore, it will not be able to run the strategically crucial new OS/2 operating system. In effect, the Model 30 is a repackaging of the basic PC. As such it provides some interesting insights into IBM's approach to this new series.

Superficially, the differences between the new and old PCs are striking. The main system box has a low profile with rather more character to the styling of the front. The on-off switch is placed here for the first time, so you will no longer need to go scrabbling around the side for it. On the right-hand side of the Model 30-021 hard-disc system we reviewed there is a lock that secures the system.

At the back there are again a number of obvious changes. On the left is the power cable and in the middle two new DIN sockets — one for the keyboard, the other for the optional Microsoft mouse. The new socket is different from the old keyboard connector, which means that you cannot transfer your old PC keyboard to the Model 30 without some messy surgery on the cable. The ports from any expansion cards that may be fitted now emerge horizontally rather than vertically, a change necessitated by the new slim-line approach. Underneath the expansion slots are the video output and the parallel port. The serial port is to the left. All these ports are now directly on the motherboard and are included as standard in the price; previously they were located on additional cards.

Unlike the earlier PC and AT, the Model 30 has a plastic casing with a metallised interior. The thought which has gone into the design is evident, even down to the way you remove the cover from the machine. Although IBM has not yet gone for what is probably the most sensible solution — a hinged casing which tilts up — it has nonetheless improved on its earlier design. Where before you had to remove screws and pull the cover forwards and up, the Model 30 has four screws at the side of the machine which do not drop out and fall on the floor, but remain captive in the casing once it is released. This will come as a great relief to everyone who has continually lost screws in the course of adding and removing cards. Unfortunately the physical process of lifting off the lid remains rather awkward.

Inside, IBM's new approach to micro construction is manifest. In contrast to the rather cluttered interior of the old PC, the Model 30 uses custom chips to reduce the chip count considerably. Chips are mounted directly on to the motherboard, again saving space.

The hard disc and floppy drive are side by side at the front; both use the 3.5in. format. The power supply is at the back to the right. It is rated at a surprisingly low 71W, which confirms the suspicion that this machine is

designed as a low-end model without real expansion capability. The on-off switch at the front of this unit is connected mechanically to the switch on the power supply itself by a stout piece of wire six inches long.

Another piece of makeshift mechanical design is used for the expansion slots. There are three of them, mounted sideways on a small card which sits in a main expansion slot on the motherboard. A flimsy plastic brace is used to support it. Inserting expansion cards the proper way into this vertical card proved much harder than with the old design, and is likely to lead to frayed tempers.

The rest of the construction shows a more high-tech approach. Since much of the video and disc-controller circuitry is on the motherboard, the interior is blissfully free of connectors. The main 8086 chip is next to the power supply, along with an empty socket for the 8087 maths co-processor. The RAM chips are of the single in-line module variety; there is 640K of RAM as standard. Also noticeable are the large square custom

IBM PS/2 MODEL 30	
PC VERDICT	
	POOR AVERAGE GOOD EXCELLENT
Performance	<input type="checkbox"/> <input type="checkbox"/> <input checked="" type="checkbox"/> <input type="checkbox"/>
Ease of use	<input type="checkbox"/> <input checked="" type="checkbox"/> <input type="checkbox"/> <input type="checkbox"/>
Documentation	<input type="checkbox"/> <input type="checkbox"/> <input type="checkbox"/> <input type="checkbox"/>
Value for money	<input type="checkbox"/> <input checked="" type="checkbox"/> <input type="checkbox"/> <input type="checkbox"/>
<input type="checkbox"/> Not a bad machine — just a bit pointless.	

chips dotted around the board, as well as the Immos chip used for colour graphics. A couple of jumper leads were visible on the motherboard, suggesting last-minute patches.

In use the Model 30 comes across as a quality machine. The keyboard has a good feel — though not up to the original PC version in terms of robustness — and the machine can support graphics that make the old PC's colours look sick. The Model 30 uses the Multi Colour Graphics Array (MCGA), which IBM says works with most software written for the existing CGA. The fact that the new top-of-the-range Video Graphics Array (VGA) is not an option on the Model 30 is a further indication that this machine is not designed as an integral part of the PS/2 series. The display monitor on the review machine was the 8513, one of the four new models launched with the PS/2. It is not possible to use the older monitors with the Model 30. The new monitor has tilt and swivel as standard; the image is steady, and we experienced none of the annoying snow found with the older display adaptor.

Running the Basic benchmarks, the machine turned in an acceptable 6.4 seconds; that makes it faster than an AT,

and even faster than an Amstrad. The discs are similarly impressive; the hard disc gave a figure of 87 seconds and the floppy around 288 seconds. Compare this with 254 seconds and 742 seconds respectively for the original IBM PC and you can see the great strides IBM has made.

Prices for the Model 30 start at £1,106 excluding keyboard, monitor and DOS, positioning it well above the average clone. The advanced assembly techniques used on IBM's automated production line means that unit costs are low, leaving considerable scope for dropping prices. This also means that clone makers will find it harder to copy the details of the Model 30 — though quite why they would want to anyway is not clear.

In fact, it is not really clear who exactly would want the machine for any purpose. Assuming the Model 50 arrives on time — and there is no reason to doubt that IBM will stick to its timetable — it is likely to become the standard PS/2 machine for business. It will be able to run most old DOS programs, plus the Eldorado of new OS/2 software once it comes through. The Micro Channel will play host to all kinds of intelligent add-in cards that were inconceivable on the older PC or Model 30, and there will be the potential to boost colour graphics.

If it is straight DOS packages that you will be running, there are going to be some tremendous bargains in the PC and AT world in the coming months. Mainstream manufacturers will gradually discount on their lines as they introduce their own answers to PS/2. Meanwhile the clone makers will be forced to intensify their efforts to win market share in this increasingly competitive sector. Unlike the Compaqs and Olivettis of this world, they do not have the resources to come up quickly with compatibles to the new series.

One likely explanation for the Model 30 is that it is designed to cater for the American education market. The pricing would be about right — though it would be too high for this country — and the combination of a neat unit with a speedy processor and durable discs would be attractive. It could also serve as a terminal — though so could even cheaper PCs. For the general market the machine is something of a curiosity. To be sure, there is nothing wrong with it, but neither is there really enough right with it to justify buying it instead of the full-blown Personal System/2 which will follow in due course.

CONCLUSIONS

- The Personal System/2 Model 30 is an 8086-based machine which shares many of the features with the others in the PS/2 family.
- It lacks the crucial Micro Channel and VGA option and cannot use OS/2. As a result, it logically forms part of the PC family rather than the PS/2.
- The Model 30 is fast, both in terms of processor speed and discs. IBM's advanced production techniques should mean that it is highly reliable too.
- Given its mixed parentage, it is hard to see who should buy it. Better to wait for the later PS/2 models or stick with straight PCs. **IK**

EPSON GQ-3500 PERSONAL LASER

By Ian Stobie

Epson makes virtually every other sort of printer and dominates the dot-matrix market, but this is its first laser.

The arrival of the GQ-3500 is an important event, as Epson dominates broad swathes of the printer market. It is Epson's first laser printer, and the inevitable high-profile Epson marketing campaign should generate a good deal of interest in this machine and laser printers in general. The GQ-3500 goes on sale immediately at a very competitive price of £1,795. This positions it at the bottom end of the laser market, in direct competition with top-end daisywheel and matrix printers.

The machine is very compact. At 35lb. it weighs just half as much as the typical first-generation laser printers such as the Canon A1 and the Hewlett-Packard Laserjet. It is also lighter and less bulky than the latest Hewlett-Packard machine, the 50lb. Laserjet II. This difference is important; you can reasonably expect to get the Epson laser printer on to the same desk as an AT and still leave room for work, which is not the case with the first-generation machines.

Internally the GQ-3500 is based around a new laser engine from Ricoh. This engine is not very fast in laser terms, being rated at six pages a minute, but this may not matter in the machine's likely market. The GQ-3500 is intended mainly for stand-alone word processing and general-purpose PC work where relatively low print volumes are the norm.

Apart from small size, the main advantage of using the Ricoh engine is that it is relatively economical in the consumables it uses. Running costs work out at 2.5p a page, not counting the paper itself, based on the toner and drum-life figures quoted by Epson.

The overall styling of the machine is good. The deeply sculpted top functions as a paper output tray. A second output tray folds down on the left-hand side of the machine. The one on top is used when you want the paper to emerge face down; this preserves the sequence of the pages in long documents. The tray on the side is for when you want the output face up, so you can read it as it comes out of the machine. I preferred to keep the machine as compact as possible by leaving the side tray folded up out of the way most of the time; if you never use it you could just remove it.

The paper input tray on the right-hand side of the machine holds about 150 sheets of A4 paper. If you need more, Epson will be offering a second input tray which will go underneath the machine. The price of this option has not been finalised, but it is known that this tray will hold 250 sheets. You can use paper in various sizes down to around A5 in the standard input tray. Envelopes and transparency film are best fed in manually, one at a time.

One of the big advantages of laser printers compared to older types of machine is that they are very quiet. The GQ-3500 is no exception; when you turn the machine on a fan starts up, but the hum is no louder than that from an AT. During actual printing it makes louder humming and whirring



Extra founts are loaded from cartridges not much bigger than credit cards.

SPECIFICATION

Description: A4 laser printer based on a new Ricoh engine

Resolution: 300 dots per inch horizontally or vertically

Speed: claimed six pages per minute

Founts: Courier 10, Modern in 12 pitch, EDP in 13 pitch, and IBM graphics founts built-in; extra founts available on plug-in cartridge or disc; two cartridge slots provided

Memory: 640K, expandable to 1.5Mbyte

Noise: claimed 52dB(A)

Paper handling: 150-sheet input, 150-sheet output, manual envelope feed; optional second input tray; prints on A4 paper, transparency film and card up to 128gsm.

Interfaces: Centronics parallel standard; RS-232C and RS-422 serial optional

Consumables: toner cartridge lasts for a claimed 1,500 pages and costs £19.50; collector unit lasts for 10,000 pages and costs £85; drum lasts 20,000 pages and costs £155, including a collector

Dimensions: 418mm.(16.5in.) x 405mm.(15.9in.) x 215mm.(8.5in.)

Weight: 16kg.(35lb.)

Price: £1,795; HP-emulation card included in price during introductory period.

Options: 1.5Mbyte upgrade memory board £340, HP-emulation card £125, Diablo-emulation card £125, fount cards £125; additional 250-sheet paper tray will be available in July, price not known

Manufacturer: Made in Japan by Seiko Epson Corporation of Nagano, Japan

UK supplier: Epson (UK), Dorland House, 388 High Road, Wembley, Middlesex HA9 6UH. Telephone: 01-902 8892

Available: now

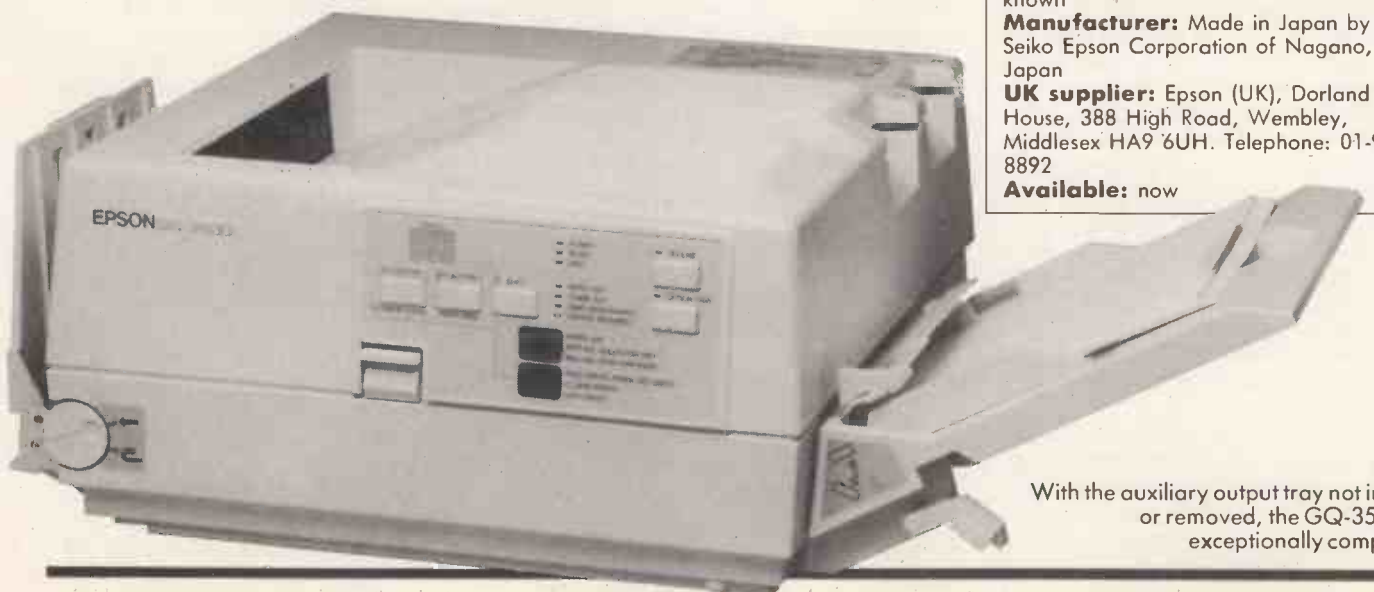

With the auxiliary output tray not in use or removed, the GQ-3500 is exceptionally compact.

MEASURING SPEED

Speed figures from all printer manufacturers are apt to be misleading, and this is particularly the case with laser printers. The speed of a laser is usually quoted in pages per minute, but you are only ever likely to get near the quoted figure when printing repeat copies of the same page, or when running out very long documents. We therefore now put printers through our own tests.

The GQ-3500 is nominally rated at six pages per minute, but as expected it comes out slower on our test at slightly under four. For comparison, we found that the new HP Laserjet II, rated officially at eight pages a minute, came out at around five. Our standard test files are short: the sample letters and listings are each three pages long, the spreadsheet two. With longer documents you get a higher average speed. This review, for example, which is a 14-page document when printed double-spaced on A4, took us 2 minutes 35 seconds on the Epson machine, which corresponds to an average of 5.4 pages a minute.

With laser printers outputting text only, the speed is not affected much by how the printed page is laid out or how full the page is. With most other types of printer this factor has a major bearing on the speed, which is why we give separate figures for printing out different sorts of material. Most of the variation in the figures for the Epson laser can be attributed simply to the length of the documents, so they should not be taken too seriously.

All laser printers take a long time to do the first page of any document, however much text is on it. The GQ-3500 takes 23 seconds to print a page with a single A on it. This is actually quite quick by laser standards; the more expensive new HP Laserjet II only manages one second better.

As you increase the amount of text on the page, the time does not go up appreciably until you start printing images that incorporate graphics. Graphics always takes longer than text on a laser, and the speed chart reproduced here took 51 seconds. By installing the optional memory upgrade you would improve the quality of the image, but printing it out would take longer still.

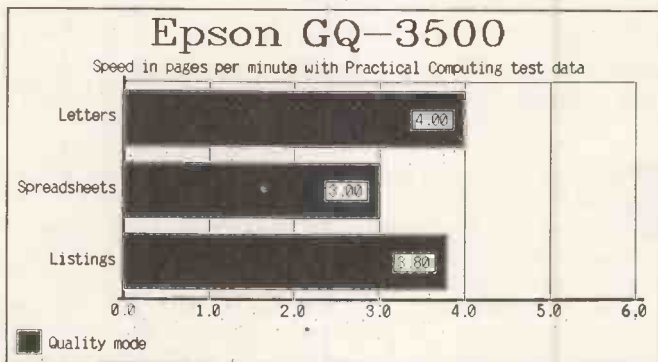

Epson GQ-3500
This is Courier

Epson GQ-3500
This is Modern Proportional

Epson GQ-3500
This is EDP, a small fount
good for drafts and spreadsheets

The three built-in founts. Printing is at 300 dots per inch, so output quality is well up to normal laser-printer standards.

sounds, but the noise level still falls far below that of any impact printer. It is not distracting if you are on the phone, for example. Epson quotes a figure of 52dB(A) during printing.

Print quality is very good — you would expect no less from a laser. All office-level laser printers are much the same in this respect, although HP's newly launched Laserjet II probably just takes the prize for quality over other popular machines. Both the Epson and the HP machines print at a resolution of 300 dots to the inch, and you are not likely to better that with current technology until you get above the £15,000 mark.

The Epson comes with three main founts; you can select the one you want using the buttons on the front panel or under software control. As well as Courier in 10 pitch and a proportionally spaced fount which looks very similar to it, you get a very useful smaller fount called EDP. In this fount the characters are about 7 points high, but they have plenty of white space top and bottom so it is a particularly good fount to use for draft work. Many people feel unduly reluctant to alter laser documents because the print looks so good, but I found EDP gets round the problem. With both Courier and EDP you can print in landscape mode — that is across the long dimension of the paper. This is obviously useful for spreadsheet work.

Among the founts built into the machine is the IBM graphics character set. Extra founts are available on cartridge, or they can

EPSON GQ-3500

PC VERDICT

	POOR	AVERAGE	GOOD	EXCELLENT
Performance	<input type="checkbox"/>	<input type="checkbox"/>	<input checked="" type="checkbox"/>	<input type="checkbox"/>
Ease of use	<input type="checkbox"/>	<input type="checkbox"/>	<input checked="" type="checkbox"/>	<input type="checkbox"/>
Documentation	<input type="checkbox"/>	<input type="checkbox"/>	<input checked="" type="checkbox"/>	<input type="checkbox"/>
Value for money	<input type="checkbox"/>	<input type="checkbox"/>	<input type="checkbox"/>	<input checked="" type="checkbox"/>

Well-specified, compact and cheap — bang on target for general-purpose office use.

be downloaded from your PC. The cartridges are very neat little things, about the size of a credit card. Both Diablo and HP Laserjet emulations are available on these cartridges as options. During the initial period following the release of the machine the HP-emulation card will be included in the purchase price.

The GQ-3500 should not be regarded as simply a daisywheel replacement. It is also capable of printing graphics. The standard machine comes with enough memory to print a whole page at 150 dots per inch (dpi). With optional expanded memory you can boost this to the full 300 dpi resolution of the printer.

While the HP Laserjet printer language is now widely supported by software and well established as the standard language for controlling lasers, Epson has opted to intro-

duce its own. This is not as daft as it sounds, as the new Epson control language is a superset of its existing Esc-P code that is the standard for matrix printers. This means that the Epson GQ-3500 is automatically capable of emulating most of the matrix printers currently on sale, which should ease problems of software installation.

The documentation that comes with the system is very comprehensive. It is divided up into a series of manuals of progressive difficulty, and it is particularly good when it comes to diagnosing faults during the initial setting-up process.

As a general-purpose laser printer for relatively low-volume use, Epson's very compact offering is excellent value. For heavier use you may need more speed, and for high-grade desk-top publishing maybe a page-description language. But Epson has targeted the mass laser market very accurately with this compact machine.

CONCLUSIONS

■ As Epson is dominant in the dot-matrix printer market, its first laser is bound to attract interest.

■ The GQ-3500 has all the features you would normally expect to find on an office laser and produces output of good quality.

■ Compared with its competitors, the GQ-3500 is light and compact; this is a significant asset for a general-purpose office printer.

■ Although not fast, the SQ-3500 has the right specification for the market it is aimed at. Coupled with a low price and Epson's marketing clout, it is hard to see it failing. **PC**

MACINTOSH SE

THE HALF-OPEN MAC

By Carol Hammond

With its new-found ability to accept expansion cards, the SE could help ease the Mac family out of the ghetto and into the wider world.

Since Apple launched the Macintosh in 1984 the machine has appeared in many guises. The original 128K Mac was joined by the 512K version, which was in turn superseded by the Mac Plus. The Mac SE — the "SE" stands for System Expansion — is the latest upgrade. It differs from its predecessors in accepting expansion cards — albeit only one at a time — making this Mac open to the outside world.

The Mac SE looks very much like the Mac Plus. Give or take a few millimetres, it is the same height, depth and width. The brightness control knob is in the same place and it has the same 9in. monochrome screen. The casing is finished in a new off-white shade that Apple calls "Platinum", which makes the old-style Macs look grubby in comparison. Depending on what disc drive you have installed, the Mac SE may be a few pounds heavier than its predecessor.

The most obvious difference is that the SE has two disc drives instead of one. One 800K 3.5in. floppy drive comes as standard; the second drive can be either a second floppy drive or a 20Mbyte hard disc. When the upper position is taken up by a hard disc the slot is covered by a piece of plastic, complete with indicator light. If you want the internal hard disc and a second floppy drive as well you can buy the stand-alone 800K Apple 3.5 Drive.

More changes are apparent at the back of the machine. From left to right lie two Apple Desktop Bus connectors, an external disc-drive connector, an SCSI port, two RS-232 ports and a sound port. Above them lie an expansion connector, the power input socket and an On/Off switch. The expansion connector is covered by a piece of plastic when not in use. You flip it out to expose the Mac's innards to the outside world and feed through any internal expansion card cables. Above and to the right of the expansion connector lies the outlet to a fan — a new addition to the Mac — which is barely audible in a normal office.

You can connect both the mouse and the keyboard via the Desktop Bus connectors; alternatively you can daisy-chain the mouse to the keyboard. You can attach the mouse to either the left or the right connector,

whichever is the more convenient. The mouse itself is lighter and flatter than the old Mac mouse. It also slopes slightly, making a more comfortable rest for your hand.

The keyboard has undergone a number of changes too. The basic model, the Standard Apple Keyboard, is like that found on the Apple II GS. An alternative keyboard, called the Extended Apple Keyboard, is available for those who want something more IBM-like. The Extended Keyboard resembles the now standard IBM layout, with 105 keys including 15 function keys — a new departure for the Mac and an indication of its move towards the IBM world — a cursor pad and a numeric pad. It costs £165.

The Standard Keyboard is flatter and wider than the unit provided with the Mac Plus. The keys have moved around as well. An Escape key is situated at the top left,

MACINTOSH SE				
PC VERDICT	POOR	AVERAGE	GOOD	EXCELLENT
	Performance	<input type="checkbox"/>	<input type="checkbox"/>	<input checked="" type="checkbox"/>
Ease of use	<input type="checkbox"/>	<input type="checkbox"/>	<input checked="" type="checkbox"/>	<input type="checkbox"/>
Documentation	<input type="checkbox"/>	<input type="checkbox"/>	<input type="checkbox"/>	<input checked="" type="checkbox"/>
Value for money	<input type="checkbox"/>	<input type="checkbox"/>	<input checked="" type="checkbox"/>	<input type="checkbox"/>

A mature version of the Mac Plus.

while at the top right a Delete key has replaced Backspace. The Return key has not moved, but Shift now takes up the space of two keys. To the left of the space bar lie the Caps Lock, Option, Apple and Backslash keys. The Shift, Control and Tab keys are placed one above the other on the left of the keyboard. You can use the Apple key instead of the mouse to choose commands from the menu.

A large new key at the top of the keyboard is called the Reset key; at present it does nothing, though when the same keyboard is used with the Apple II GS it does reset the system. As with old-style Macs an optional programmer's switch clips on to the left side of the machine. One of its two buttons resets the machine while the other acts as an interrupt switch.

The Mac SE still runs a basic 68000 CPU at 8MHz, but Apple claims that its performance has been enhanced by around 10



SPECIFICATION

CPU: 68000 running at 8MHz
RAM: 1Mbyte, expandable to 4Mbyte
ROM: 256K
Disc storage: one 800K 3.5in. floppy as standard; second floppy or 20Mbyte hard disc optional
Display: 9in. 512- by 384-pixel monochrome screen
Keyboard: choice of Apple II GS style or 105-key model with 15 function keys
Interfaces: two Apple Desktop Bus connectors for keyboard, mouse, etc.; two RS-232 ports; external disc interface; SCSI interface; sound port; expansion connector
Size: 345mm.(13.6in.) x 244mm.(9.6in.) x 277mm.(10.9in.)
Weight: between 7.7 kg. (17lb.) and 9.5kg. (21lb.), depending on discs installed
Hardware add-ons: external disc drives; IBM-compatible 5.25in. floppy-disc card
Software in price: none
Price: twin-floppy version £2,495; 20Mbyte hard-disc versions £3,195
Manufacturer: Apple Computer U.K., Eastman Way, Hemel Hempstead, Hertfordshire HP2 7HQ. Telephone: (0442) 60244
Available: now

percent to 25 percent over previous machines. Apple claims that this improvement arises from its use of gate arrays; 19 chips have been squeezed on to a single chip. The Mac SE seemed faster in operation than the Mac Plus, and our benchmark tests confirm this subjective impression. Benchmarking the Mac is an awkward task since there are no standard benchmark routines to run. We tested it out by timing how long it took to load and save a typical file, using the internal floppy and hard discs of the Mac Plus and the Mac SE.

When it came to running old Mac applications the SE did not exhibit any compatibility problems, and ran whatever we gave it. Packages we tried included Macwrite, Write Now, Reflex, Jazz and Just Text.

The most significant innovation on the Mac SE is its expansion slot. But while IBM machines are truly open to the user you have to get an Apple dealer to remove the casing of the machine and install an expansion card. This seems rather silly. Not only is it time-consuming to have to get someone else to do the job for you, it can also be expensive. You might have to pay around £35 an hour if you ask your dealer to install a card you have acquired from another source. Even if you are prepared to invalidate your war-



Above: A lot is packed into the limited space inside the SE.
Right: The 256Kbit RAMs can be replaced by larger chips to boost the memory.

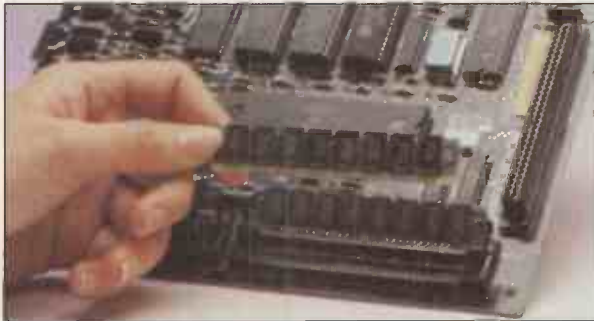

Below: The Mac SE's motherboard.

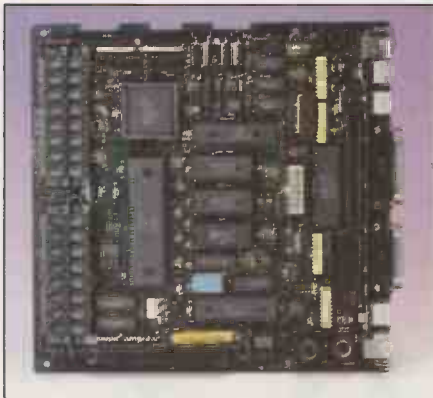

rantly by opening the case yourself, you may still run into problems. You need a long-handled screwdriver to cope with the Mac's unusual five-point star screws. If Apple really does want to let users expand the Mac and encourage third-party manufacturers to devise add-ons for it, the company really should make it easier for users to get inside and install their cards. The inside of the Mac SE is more crowded

even than the Mac Plus, with the new fan and hard disc all taking up scarce space. The hard disc is mounted above the floppy disc, and below that there is space for expansion-cables. The motherboard lies right at the bottom of the machine.

On previous Macs the battery for the clock was accessible from outside the machine, but on the SE it is mounted on the motherboard. It is said to have a life expectancy of seven years. The Euro-DIN bus used by the expansion cards is accessed through a 3 x 32-pin connector and ties in directly to the full bus of the 68000. This allows add-ons to take full control of the machine or carry out functions independently of the main processor. The hard disc and floppy-disc drive plug straight into the motherboard. Expansion cards lie face-to-face with the motherboard.

Memory chips are mounted on cards which plug into single in-line memory module (SIMM) slots. There are four such slots which take little cards tilted at an angle to the motherboard; on the standard SE each card carries eight 256Kbit chips, making a total of 1Mbyte. Memory can be increased by

swapping in new chips. Apple offers 1Mbyte cards, allowing memory to be upgraded to 4Mbyte.

There have been a number of alterations to the Mac's Finder, which has now progressed to version 5.4. An Access Privileges option is now available from the Apple menu to allow users of the Appleshare file-server software to regulate access to certain files and folders. The Get Info option gives additional details about where files and folders are, along with when they were created and last modified.

The Control Panel allows you to change the desk-top pattern, rate of cursor blinking, speaker volume and RAM cache just as on earlier Macs. In addition you can now use the Control Panel to change the menu blinking rate and date, and choose whether you want a 12-hour or 24-hour clock.

The Apple menu has a new option labelled Find File, which you use to find any folder or file on a disc. If you choose Find File, a box appears in which you key in the name or part of the name of the folder or file you are searching for. Matching names are displayed in turn; you click on any that you are interested in, and Find File displays information about when it was created, when it was last modified, its size and how to get to it.

The Chooser has also changed. You can now use it not only to select printers and modems, but also to indicate whether you have a network connected to Appletalk. If your network has zones, the Chooser lets you scan them for the devices they contain. The Special menu has an addition too in the form of Restart. This option ejects any inserted discs, saving any necessary information first, and then restarts the Mac SE.

Learning how to use the Mac SE is made reasonably painless by the clearly presented information in the manual, which includes helpful screen dumps throughout. The Guided Tour on the hard disc takes you in hand-holding fashion through the basics of using a mouse and pull-down menus. The System Tools application on the hard disc contains an Update folder, which gives details of late changes not included in the printed documentation. The manual comes with a booklet called the *Macintosh Utilities User's Guide*. It describes six utility programs, but only people well used to using a micro are likely to resort to them. They include Find File, Hard Disk Backup and Disk First Aid.

CONCLUSIONS

■ The Macintosh came of age as a business machine with the Mac Plus; the Mac SE is faster and more powerful and has more features of benefit to business users.

■ Those wanting to compare the worlds of IBM and Apple will have to wait for the Mac II to give Apple a fair showing.

■ Apple has made gestures towards opening up the Mac but access to the SE's single slot is too difficult for it to be called an open architecture. However, the Mac SE offers data compatibility with MS-DOS, as well as links to Ethernet and hence to Unix; this should widen its potential appeal.



SETTING THE STANDARD

TRISOFT LTD 0629-733111

PROFESSIONAL ADVICE ► LOW PRICES ► HOT LINE SUPPORT ► FAST SERVICE

Whether you are seeking specialist advice or simply wish to buy at a competitive price, we believe that Trisoft Ltd. offers a service second to none. Apart from offering around 300 software packages and a large range of add-on boards, we are also authorised dealers for APRICOT, OLIVETTI, TANDON and NORTHSTAR.

► SOFTWARE

DBASE III PLUS.....	£335
LOTUS 1 - 2 - 3.....	£239
FRAMEWORK 2.....	£320
SUPERCALC 4.....	£195
WORDSTAR 2000.....	£245
DATAEASE.....	£385
REFLEX.....	£79
MULTIMATE.....	£199
MS WORD 3.....	£260
WORDCRAFT.....	£320
WORD PERFECT 4.2.....	£260
WORDSTAR PROF.....	£215
MULTIPLAN 2.....	£145
VP PLANNER.....	£75
JAVELIN.....	£380
SMART 3.....	£395
SYMPHONY.....	£339
DOMINO.....	£375
LATTICE C.....	£275
MS C COMPILER.....	£265
PEGASUS.....	P.O.A.
MULTISOFT.....	P.O.A.

► BOARDS

INTEL ABOVE BOARD FROM	£295
RAMPAGE.....	P.O.A.
AST SIX PAK PLUS 384K.....	£245
AST 5251 MOD.11.....	£599
HERCULES MONO PLUS.....	£189
HERCULES COLOUR.....	£115
PARADISE AUTO EGA.....	£295
ORCHID TINY TURBO 286.....	£395
INTER QUADRAM EGA + (SHORT).....	£275

► PLOTTERS/LASER PRINTERS ETC.

ROLAND DXY-880A A3 PLOTTER.....	£675
ROLAND DXY-980A A3 PLOTTER.....	£945
ROLAND DPX 2000 A2 PLOTTER.....	£3245
HP LASER JET.....	£2185
HP LASER JET PLUS.....	£2885
CALCOMP 1043 A0 PLOTTER.....	£7643
CANON LBP A1 LASER.....	£1985
CANON LBP A2 LASER.....	£2985
TONER CARTRIDGE FOR A1/A2.....	£85
8087/80287.....	P.O.A.
MS MOUSE.....	£145
PC MOUSE.....	£145
SUMMA MOUSE.....	£89

► COMPUTER SYSTEMS

ALL SYSTEMS INCLUDE MONO SCREEN, KEYBOARD AND MSDOS

OLIVETTI M24 SP, 10 MHZ PROCESSOR, 20 MB HARD DISK, 640K RAM.....	£1995
OLIVETTI M28, 20 MB HARD DISK, 512K RAM.....	£2295
OLIVETTI M28, AS ABOVE BUT 40 MB HARD DISK.....	£2995
FOR COLOUR MONITOR ADD.....	£235
APRICOT XEN-i HD, 20 MB HARD DISK, 1 MB RAM, PAPER WHITE MONITOR.....	£2495
APRICOT XEN-Xi10, 10 MB HARD DISK, 512K RAM, PAPER WHITE MONITOR.....	£1695
APRICOT XEN -Xi20, AS ABOVE BUT 20 MB HARD DISK.....	£2045

►► FULL TANDON RANGE ◀◀
►► NOW AVAILABLE ◀◀

ACCOUNTING SOLUTIONS FROM TRISOFT

TRISOFT LTD. are authorised dealers for SAGE, PEGASUS, MULTISOFT, TETRA and MULTIPAC accounting software.

PEGASUS, MULTI-USER and XENIX systems.

MULTISOFT & TETRA, XENIX systems.

Unrivalled accounting expertise in London and the Midlands.

We supply software only or full systems.

Full range of training and maintenance support services from our qualified accountants.



► EXAMPLE SYSTEMS

TANDON PCX 10, 10 MB HARD DISK, 1x360K FLOPPY, 256K RAM KEYBOARD, MONO MONITOR, MS-DOS, ANY 4 PEGASUS MODULES.....	£1595
OLIVETTI M28, 2 MB RAM, 4-WAY SERIAL CARD, LEVEL V XENIX, KEYBOARD, MONO MONITOR, 3 x WY-50 WYSE TERMINALS, 4 x MULTISOFT XENIX MODULES.....	£8995.00

► ENTRY LEVEL CAD SYSTEM

OLIVETTI M24, 20 MB HARD DISK, 1 x 360K FLOPPY, 640K RAM, 7 EXPANSION SLOTS, MONO MONITOR, KEYBOARD, MS-DOS, ROLAND DXY-880A A3 PLOTTER, CALCOMP 2200 DIGITIZER, AUTOCAD, AUTOCAD ADEX 1 + 2, 8087 8 MHZ CO-PROCESSOR ..

£5495.00

► PROFESSIONAL CAD SYSTEM

TANDON PCA 20, 80286 PROCESSOR(8 MHZ), 640K RAM, 20 MB HARD DISK, MONO MONITOR, KEYBOARD, MS-DOS, CAMBRIDGE 1024 20" MONO SCREEN (1024 x 768 RESOLUTION), AUTOCAD WITH ADEXS 1,2 AND 3 (VERS. 2.5), 80287 CO-PROCESSOR, CALCOMP 25120 DIGITISER, CALCOMP A0 1043 PLOTTER, FREE ON-SITE INSTALLATION IN MOST PARTS OF THE U.K. 3 MONTHS ON-SITE WARRANTY ..

£13950.00

► COMMUNICATIONS

We supply the complete range of HAYES and DOWTY (HAYES-Compatible) MODEMS and SUPPORTING SOFTWARE for most communications requirements. Please call for details.

► EDUCATION

Users in Education please call for details of special prices available on certain products.

Attractive LEASE and LEASE PURCHASE Facilities Available.



► All prices are subject to carriage and V.A.T. ► All software prices are for IBM and compatibles. For other formats, please enquire.

TRISOFT LTD

DARLEY DALE, MATLOCK, DERBYSHIRE DE4 3BP

TELEPHONE (0629) 733111, TELEX 8950511 ONEONE G (please quote ref - TRISOFT.)

► ELECTRONIC MAIL - TELECOM GOLD 83: NTG344 ONE TO ONE 12977001 PRESTEL 533544601...►

→ circle 134 on enquiry card ←

"It's a great machine".



From only
£499

A PC which can beat the likes of Amstrad, Tandy and Zenith in a press comparison of IBM-compatibles, deserves your attention. So does a company whose computer sales in Britain now exceed the entire production of some of its rivals.

The Company in question is Opus and its class-beating compatible is the PC II Turbo, now being built in Britain in monochrome, colour and EGA versions. 'PC User' Magazine which conducted the comparison test said of the PC II Turbo:

*"Even in its basic £499 form, it is a superior beast.
This is a great machine."*

. their words not ours

But what really makes the PC II Turbo stand out from the compatible crowd? The answer it seems depends on which computer magazine you read.

"Performance is above average, thanks to the NEC V20 chip. The PC II exhibits excellent compatibility, no doubt due to its US-registered legal ROM Bios."

'What Micro?'



"The Opus PC II looks and feels like a solid beast. Expansion cards fit firmly inside, the keyboard doesn't feel like it might break if you hit it too hard and the monochrome display offers a clean and rock-steady picture."

'Which PC?'



"It is extremely solid and well built. It lacks the thrown together feel of many cheaper clones from small companies."

'Which Computer?'



NEED WE SAY MORE? . . . YES NOW THE PC II TURBO IS EVEN BETTER

Even our £499 entry level PC is now equipped with a new dual-mode graphics card supporting both the Hercules monochrome and IBM colour graphics standards and featuring a mouse port and PAL-compatible video output. It keeps the PC II Turbo's standard specification out in front.

- Software switchable NEC V20 super processor 4.77/8 MHz
- Dual-mode mono/colour graphics card
- High resolution monochrome monitor, tilt and swivel base and anti-glare screen
- Quality AT-style keyboard
- 256K of RAM expandable to 1Mb on motherboard creating 384K RAM disk
- 360K floppy disc drive
- 8 expansion slots
- Highly compatible BIOS
- Parallel printer, mouse and joystick interfaces
- Real-time clock/calendar with battery back-up
- Keyboard security lock
- PAL-compatible video output
- 150 watt UL-approved power supply
- 12-month guarantee
- Comprehensive user manual.

Options include dual drives, 20 Megabyte Winchester and 1 Megabyte RAM expansion, maths co-processor and on-site maintenance cover.

We offer special education and government discounts and welcome dealer and export enquiries. For details call Opus today on **0737 65080**. Price quoted exclusive of VAT and carriage.

Opus.

PC II TURBO

A small price to pay for quality

Opus Supplies Ltd, 53 Ormside Way, Holmethorpe Industrial Estate, Redhill, SURREY RH1 2LW.

→ circle 136 on enquiry card ←

FREE

Full preview disk
in PC Plus on
June 18th issue

ABC

THE ONLY ALL-IN-ONE BUSINESS PACKAGE FEATURING!—

● **TYPING & WORDPROCESSING**

wordprocessing for business letters, quotations, etc; with mail merge and calculations.

● **FILING**

card-index database; multi-index; with report generator and label print routines.

● **BOOK-KEEPING**

incorporates INVOICING, SALES PURCHASE, NOMINAL and CASHBOOK. Prints Statements, Daybooks, Audit Lists, Remittance Advice, VAT Return, Profit/Loss and Balance Sheet, foolproof double-entry system. Approx Capacities.

● **STOCK CONTROL**

Linked to Sales Invoicing. Keep records of stock history and movements. Ideal for valuation reports and controlling stock levels.

● **SPREADSHEET CALCULATOR**

Mathematical operations; percentage calculating and replication of functions are all performed on this easy to use 26x60 spread sheet calculator, ideal for Cashplan forecast, Costing and "What If" calculating.

PLUS . . .

● Electronic Notepads, Phonebook, Diary and Alarm Calls, Backup routine, Printing Calculator, Access to MSDOS within program, Links to DESKTOP PUBLISHING Packages, User definable Printer Definitions, Screen Colours, Help Screens, Passwords.

● **AFTER-SALES**

User Club with telephones Help-Line, and Newsletter full of hints and tips.

● **OPERATION**

A-B-C is completely Menu driven, with many Help Screens, making it ideal for beginners. However, experts will find there are many shortcuts and powerful "hidden" features for when you want to go faster.

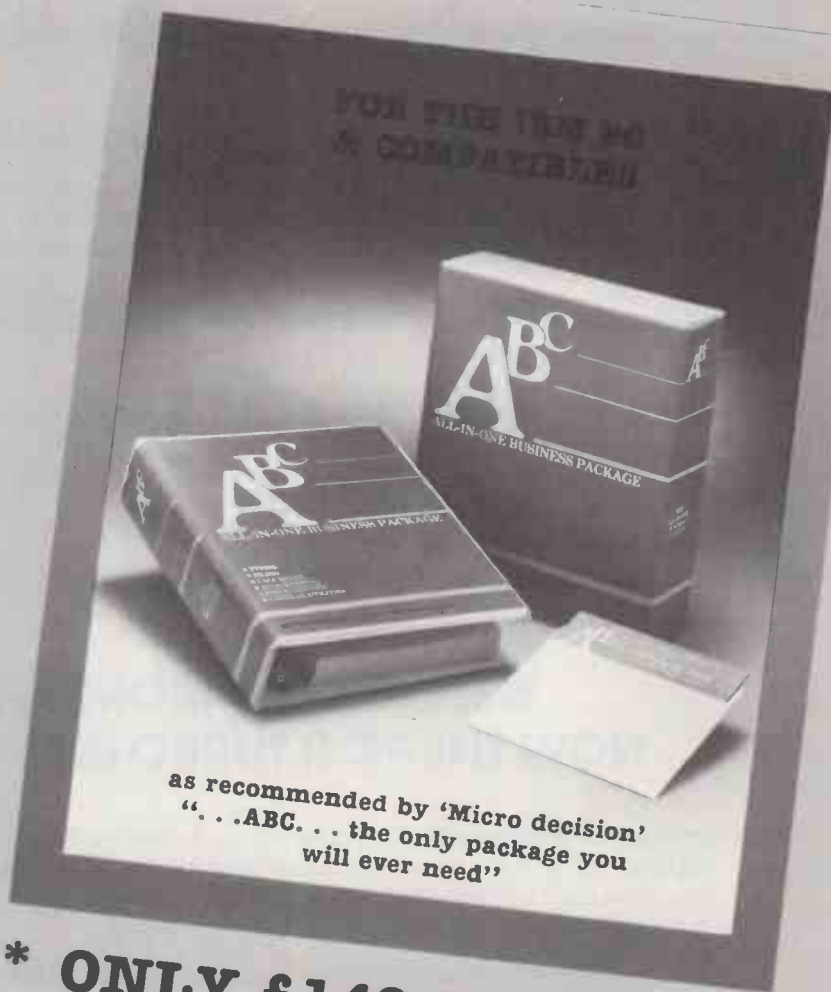

as recommended by 'Micro decision'
". . .ABC. . . the only package you
will ever need"

*** ONLY £149.95 + VAT ***
ABC available on 5¼" & 3½" diskettes

Available from

SOFTSAL 021-356 3388

CENTRESOFT 01-568 8866

A-B-C SYSTEMS LTD 01-661 0488

A-B-C SYSTEMS LTD., Regent House, 188 High
Street, Sutton, Surrey, SM1 1HH.

Telephone: 01-661 0488 Tele gold 265871 MONREF G/MAG70113

→ circle 137 on enquiry card ←

The data protector.

(A SOFTWARE LOCK ON YOUR MICRO OR NETWORK)

Is 'personal' data on your micro secured in accordance with the Data Protection Act?
Is sensitive data secure on your micro?

If the answer to either of these questions is NO then you need CLAM from MICROFT TECHNOLOGY. CLAM, as the name implies, provides a software 'shell' around your computer to prevent unauthorised access to programs and data. It can be used to protect either individual files or subdirectories or both. Each copy of CLAM includes a copy of Microft's popular menu generator MENUGEN, so that users, if required, can be presented with a friendly menu interface.

On starting the computer users are asked for a password. They will then be presented either with a menu or the normal DOS prompt. In either case they will only be able to access those files and subdirectories for which they have authority.

Files are protected using 'Dynamic File Encryption'. Under this technique the files are held on disk in a permanently encrypted form. When an authorised user reads the file the data is automatically decrypted by CLAM after it is read from the disk but before it is given to the user. The time taken is imperceptible. When a file is updated the data from the user is automatically encrypted before it is written. This is the only failsafe way to secure data.

CLAM is available for most micros with PC/MS DOS version 2.0 or later. These include the

MAIN FEATURES

1. All data held on a hard or floppy disk or a network can be kept secure from unauthorised access.
2. Security is by default and is failsafe. Once CLAM has been set up the user does not have to take any positive action to secure data.
3. Access to all activities can be controlled via user defined menus within CLAM.
4. Each user is given a user name and password. These determine which menu options the user will see and which files he or she may use. Each user needs to remember only one password.
5. Protected files are kept in a permanently encrypted form on the disk. Even if there is a power or hardware failure the data will never be readable by an unauthorised user.
6. The algorithm that encrypts all files and subdirectories uses the individual CLAM serial number in its key. One copy of CLAM cannot therefore access files or subdirectories encrypted by another copy.

IBM PC and all compatibles. CLAM costs £148 + VAT for a single user licence. Site and corporate licences are available. Existing MENUGEN users may upgrade to CLAM for £110 + VAT.

CLAMNET, the network version will run on all PC/MS DOS based networks. The cost is £580 + VAT per ten or part of ten workstations on the network.

CLAM may be purchased from MICROFT TECHNOLOGY LTD, The Old Powerhouse, Kew Gardens Station, Kew, Surrey TW9 3PS or from most dealers. To order or obtain further information telephone 01-948 8255.



CLAM

THE DATA PROTECTOR

There are now over 10,000 users of Microft products worldwide.

ALDUS PC PAGEMAKER

THE PRICE OF BEING FIRST

By Carol Hammond

When Aldus launched its desk-top publishing package on the Mac it had the field to itself, but the PC version is up against some stiff competition from more modern software.



Pagemaker appears within Windows, complete with menu and scroll bars.

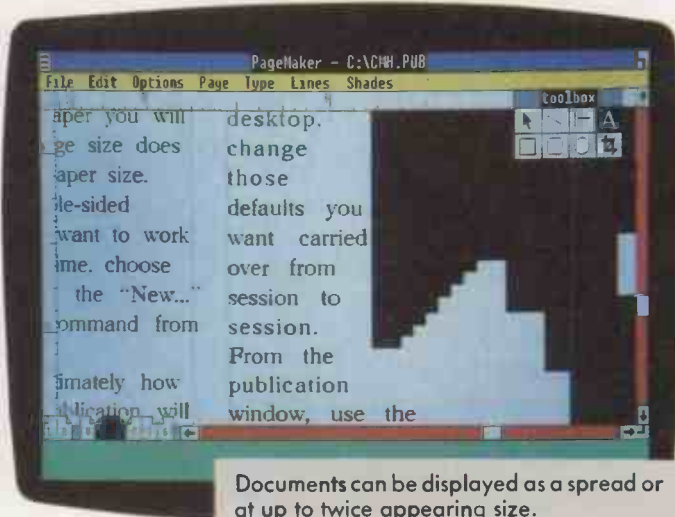

Documents can be displayed as a spread or at up to twice appearing size.

Aldus coined the phrase "desk-top publishing" (DTP), and the combination of Aldus Pagemaker, the Macintosh and the Apple Laserwriter is what really created the DTP market. Since we reviewed the original version for the Mac back in January 1986, Aldus has gone on to sell 50,000 copies of Pagemaker worldwide and it is now considered to be the industry standard. The appearance of a PC version of the package is something many people have been waiting for, especially those reluctant to opt for DTP on a Mac.

The arrival of PC Pagemaker is important because of its exploitation of Microsoft Windows to provide a Mac-like user interface, and because Aldus probably hopes to repeat its success on the Mac in the PC market. Its use of Windows has become of even greater interest since the announcement of OS/2. Many people may be keen to look at the package, not just as an example of a DTP package, but also as an indication of the shape of things to come.

How Windows is displayed on your screen depends on how you have installed your system. If, like us, you have a run-time version of Pagemaker with Windows then you will only have access to those features included with Pagemaker. If you have a separate full version of Windows on your system you will be able to use all of its features. This means you will be able to run Pagemaker in one window and a different Windows application in another.

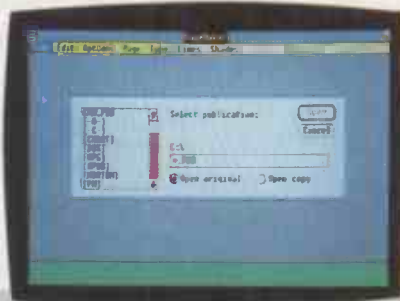

Selecting Open from the File menu calls up a listing of the current sub-directory.

Each Pagemaker window is divided into several areas. The System menu box lies at the top left corner of the screen, rather like the Apple menu on the Mac. To the right lies a title bar to show the name of the current file. Underneath lies the menu bar, which lists the names of the pull-down menus: File, Edit, Options, Page, Type, Lines and Shades. Scroll bars lying to the right and bottom of the screen allow you to scroll through a window or dialogue box. Finally, the size box to resize the window lives at the top right corner of the screen. The scroll bars can be removed to give you more room on-screen if you wish — something you cannot do on the Mac.

If you are used to using a Mac, the transition to Pagemaker and its use of windows is absolutely painless. The scroll bars work in the same way. You cut, paste and edit the same way. The menus pull down and pop back up once a selection is made, as they

would on the Mac. An egg-timer icon, like the Mac's watch icon, tells you to wait while operations are being performed. You click on your mouse in a similar fashion; you can use the keyboard if you wish, but this is not easy when using a DTP package.

When you read or save a file, Pagemaker displays a Mac-like dialogue box in which you can specify a file name. This is not as straightforward as on the Mac, where you can choose any name you like. The dialogue box contains a list of file names, drive icons and directories you can choose from, plus a blank text box where you can type in a file name acceptable to DOS. It is here that



MS-DOS users are going to feel most at home, and pampered Mac users are not.

If you click on the parent directory marker [...]

Windows displays the next higher level of file organisation. For example, if you are looking at a list of files in a particular sub-directory, double-clicking on the parent directory marker displays a list of sub-directories, including the one you were in. Doing the same again then displays a list of directories.

If you have a file open, its name will appear above the text box. File names can have up to eight characters and include a full point followed by a three-character extension. You can also include a drive letter followed by a directory name, such as C:\WINDOWS\WORKPG.PUB

If you do not see the file name you want in the list box, you can use wild cards to specify a file name. To move to another directory you double click on the parent directory marker, which will list all the directories available in the current drive. Similarly, to move to another disc drive you double click on one of the drive letters enclosed in brackets and this will list all the directories on that drive.

The System menu functions like the Apple menu on the Mac, though there are some differences. It is here that you access Help specific to Pagemaker; the Mac's Apple menu contains only system information. On PC Pagemaker the Clipboard is accessed from the System menu, whereas on the Mac it would typically be present on an Edit menu. Although the Spooler controls printing, it is nothing like the Mac's Chooser, where you choose what port your printer is connected to. To do this with Pagemaker you choose Control Panel from the System menu then choose the Connections command from the Setup menu. Spooler displays the print queue.

The Control Panel is where you adjust the date, time, cursor blink rate and mouse click rate. You can also access the Preferences, Installation and Setup menus where you change screen colours and currency format, set up printers and communication ports, and add or delete printers and fonts.

Obviously in our version of Pagemaker we could not zoom and move windows around, but as it was the only application running under Windows this did not matter. We were unable to use the MS-DOS Executive window for the same reason. If you install Windows separately, you can carry out DOS commands such as copying and deleting files by choosing commands from one of the three MS-DOS Executive menus without having to close Pagemaker and return to the DOS prompt.

Worthy as Pagemaker's use of Windows may be, this alone is unlikely to sell many copies: Developers and users may be keen to see what Pagemaker looks like, as a taster to OS/2, but even then the version of Windows incorporated in Pagemaker is 1.3, not the new version. Aldus will, of course, have to win sales on its product's merits as a DTP package, and its performance in this area is rather disappointing.

One of the reasons Pagemaker became the industry standard is that it was there first. It

ALDUS PC PAGEMAKER				
PC VERDICT				
	POOR	AVERAGE	GOOD	EXCELLENT
Performance	<input type="checkbox"/>	<input checked="" type="checkbox"/>	<input type="checkbox"/>	<input type="checkbox"/>
Ease of use	<input type="checkbox"/>	<input type="checkbox"/>	<input checked="" type="checkbox"/>	<input type="checkbox"/>
Documentation	<input type="checkbox"/>	<input checked="" type="checkbox"/>	<input type="checkbox"/>	<input type="checkbox"/>
Value for money	<input type="checkbox"/>	<input type="checkbox"/>	<input checked="" type="checkbox"/>	<input type="checkbox"/>
<input type="checkbox"/> Windows makes it easy to use, but already looking dated.				

took personal computers into a new area and allowed users to combine word-processed text and graphics in a form fit for publication. Things have moved on a long way since then, and despite the PC version of Pagemaker being a great improvement on the original Mac version, it seems run-of-the-mill compared to packages such as Xpress on the Mac and Ventura Publisher on the IBM PC. It is as though Aldus has spent so much time getting Pagemaker on to the IBM PC that it has been unable to include some of the advanced features now to be found in other packages.

Admittedly, Pagemaker does have the great advantage that it uses Windows, which puts it one step ahead in the race towards OS/2 DTP packages. However, Ventura Publisher is already being rewritten to run under OS/2 and the publisher of Harvard Professional Publisher is said to be thinking about it. These rival packages may yet be able to catch up on the system side so as to compete on DTP prowess alone.

When you first enter Pagemaker, the screen shows the menu bar along the top. You select New from the File menu, which will bring up a dialogue box where you specify page size and orientation, margins, and the starting page and number of pages. Documents can be up to 128 pages long.

You also specify whether your pages are to be single- or double-sided and whether single or facing pages are to be displayed on-screen. Your page will then appear in the working area.

Although the scroll bars, menu bar, etc. appear in colour, the working area and your page are shown in black and white. Pagemaker does not handle colour in the way, say, Xpress — reviewed last month — on the Mac can. You cannot assign colours to text or graphics on-screen, nor does it have facilities for making colour separations. To do this you would have to move chunks from a page, section by section, and print them separately according to the colour you wish them to appear in. For example, you could print only a headline, because it will be blue, then print the body text because it will be black. But Pagemaker does not print registration marks to help you line pages up afterwards. It is ironic that a package on the Mac — hitherto notorious for its lack of colour capability — does this while packages for PCs with colour capability do not.

The page will have dotted lines where the margins are and a toolbox will appear in the working area. It contains eight tools, like those in the original Pagemaker, with which you select and edit text and graphics, draw lines and shapes, and crop graphics.

MEASUREMENTS FOR BOXES AND PAGE GRIDS

Using the Options menu, you can include rulers, guides and column guides, and choose different corner shapes for boxes. By choosing preferences from the Edit menu you can select what unit of measurement you want to use: inches, millimetres, picas, points or ciceros. Column guides allow you to choose how many columns you want to a page and what gutter width you want.

You can view your page at actual size or at 50 percent, 75 percent or 200 percent of actual size. You change the size using the Page menu. You can also have your page or pages fit in the window, which will give you a rough idea of what your final pages look like and can be used for entering large chunks of text. This option is, however, useless for detailed work, since it renders illegible anything except large headlines.

Files can be imported from Microsoft Word, Microsoft Windows Write, Word Perfect, Multimate, WordStar 3.3 and IBM Display Write 3. Graphics can be imported from the usual IBM paint-type programs and scanners as well as from Autocad and EPS-format files.

Icons representing pages appear at the bottom of the screen, with the current page highlighted. Two of the page icons are labelled L and R. These are the master pages, which you can set up as grids for your other pages to follow. Anything you want repeated on every page — like running heads, logos and suchlike — you set up on the master page. However, you cannot apply global settings to items so that all headlines appear in a certain type size and style, as you can, for example, in Ventura Publisher. Automatic features like these are

SPECIFICATION

Description: WYSIWYG page makeup program with built-in word processor and run-time version of Microsoft Windows 1.3

Hardware required: IBM PC/AT or compatible with at least 512K RAM, 10Mbyte hard disc, IBM EGA or Hercules Graphics Card; Microsoft Windows compatible mouse; Postscript-compatible output device or printer supported by Microsoft Windows, such as HP Laserjet

Copy protection: master disc required to print

Price: £549

Publisher: Aldus of Seattle, Wa

UK supplier: Aldus (UK), Craigcrook Castle, Craigcrook Road, Edinburgh EH4 3UH. Telephone: 031-336 1727

Available: now

(continued on next page)

(continued from previous page)

particularly useful when handling long documents.

You can insert and remove pages using the Page menu. Pagemaker will renumber pages as necessary, and reposition text and graphics to accommodate differences between the inside and outside margins where appropriate. But Pagemaker does not generate continuation lines automatically, nor does it have the facility to generate an index or table of contents. Pagemaker is page-orientated and is not as suited to handling long, heavily formatted documents as some of the more sophisticated word processors like Lotus Manuscript, or DTP packages like Ventura Publisher.

Compared with other packages, Pagemaker seems to require more layout work on the part of the user and does less work for you automatically. For example, when you import text using the Place command, a text icon appears, which you position where you want. The text flows into the column, stopping when it ends or, if it is a long file, at the bottom of the column. If the text does spill over the bottom of the column, a line appears at either end of the text, with a tab at each end. The bottom tab will have a + sign indicating there is more to come. This is like the original Pagemaker; to get the text to flow into the next column you have to click on the tab so that the text icon reappears. You move it to the point where you want the text to continue from and enter it again. The whole procedure accurately

mimics the real-life paste-up operation, but we have been spoilt by DTP packages which allow text to flow automatically from one column to the next, wrapping round graphics as it does. Pagemaker seems pretty laborious by comparison.

Wrapping text around graphics also proves to be a chore. Just as a paste-up artist would pick up a scalpel and cut up every line to fit it around an awkward shape, so in Pagemaker you have to hit Return at the end of a line to stop it from running over a graphic. Not only would doing this automatically save time, it would also produce a tidier result, as the program could be set to leave the same amount of space between text and graphics all the way round.

WORD PROCESSING

Pagemaker's word-processing capability is fairly rudimentary. There is no search and replace, though there is a 100,000-word dictionary. Doing headlines, in particular, proved tiresome. I could not make a text box to span two columns, but instead had to type out the headline on the pasteboard area surrounding the page and select that text block, using the pointer tool. I then had to drag a corner handle of the text block until the headline was the width I wanted, and place it in the position required.

Obviously, by the time pages are being laid out, most of the word processing has been done elsewhere and the files imported are in a fairly finished form. Nevertheless, headlines are a major part of most publica-

tions and I did not expect to have to go to the Advanced Techniques part of the user manual to find out how to do two-column headlines.

The manual itself was adequate, but as with all large packages, finding your way around the documentation can prove difficult. There are numerous cross references to other parts of the manual, and in this case to the Microsoft Windows User's Guide too.

CONCLUSIONS

■ Pagemaker is still a reliable DTP package which, thanks to its use of Windows, is easy to use. Unfortunately for Pagemaker the DTP market has matured a lot over the past 18 months, which makes some of its features appear clumsy.

■ It does not handle long documents as well as some of its rivals on the IBM PC; sophisticated word processors such as Lotus Manuscript and Write Now will force it towards requiring more sophisticated features, which DTP packages like Xpress on the Mac already have.

■ Pagemaker may have the edge over some of its rivals in the OS/2 packages race because of its implementation of Windows, but it will have to maintain its lead by adding more features and improving its handling of long documents.

■ Aldus may succeed in pushing Pagemaker to the top of the pile because of the strength of its reputation and its alliances with other manufacturers. Aldus and Microsoft have a joint dealer-training scheme in the UK, while Apricot is offering a ready-to-go Pagemaker-based system: Pagemaker could yet become the Lotus 1-2-3 of the DTP world. 



MULTI-USER SYSTEMS

DESK TOP PUBLISHING

ON SITE TRAINING

ON SITE SERVICING

AFTER SALES SUPPORT

**CALL FOR A PRICE
AND GET
PROFESSIONAL ADVICE
(0280) 816087**



Visit our demonstration
showroom and see the
complete Apricot range
including the Xen multi-
user system.

Also see Apricot's high
performance Desk Top
publishing system
incorporating Aldus
PageMaker and both the
Kycocera and the Apple
Laserwriter Plus printers.

Bristle Hill Buckingham
Bucks MK18 1EZ
(0280) 816087



FRASER
Associates Limited





MICROCHART PLUS

BUSINESS GRAPHICS

By Steve Malone

Compsoft's general-purpose graphing package is looking for a niche between the complex heavyweights and the ultra-cheap small-business programs.

Mid-priced presentation-graphics programs are thin on the ground, as activity in the genre has traditionally been concentrated at the two extremes, rather than in the middle. At the top end are the advanced, high-performance packages such as Harvard Presentation Graphics and VCN Concorde. Programs like Gem Graph, at the bottom end of the range, are intended mainly for the small-business user who occasionally wants to knock up a simple presentation chart. In between there is an obvious niche for a modestly priced program which can nevertheless produce a wide and varied selection of graphs and charts. Microchart Plus claims to be just such a package.

Most presentation-graphics packages have a formidable installation menu offering any number of display types, printers and plotters. We were therefore surprised to discover that Microchart Plus supports only a modest selection of displays and output devices. The display menu, for example, only offers IBM monochrome graphics, CGA and Hercules graphics. There is no mention of EGA mode.

The manual does refer to the EGA card, but suggests that owners might install the card to display monochrome graphics, as this offers a better resolution. In this case, the manual is absolutely right; including colour reduces the resolution drastically, and makes all but the largest text annotations unreadable.

We encountered a similar problem with printer installation. Laser printers, with their capability for high-resolution graphics, generally produce the best presentation documents. We therefore intended to install a Mannesmann-Tally 910 laser printer for use with the package, but unfortunately Microchart Plus has no drivers for any laser printers at all. It simply provides you with a list of fairly standard dot-matrix machines. We ended up installing our laser printer as though it were an Epson FX dot-matrix, which seemed a bit of a waste.

The selection of plotters supported by the package is more generous, covering a variety of Hewlett-Packard and other systems. When we spoke to Compsoft, Microchart's distributor, we were told that the company was aware of the deficiencies in the display and printer drivers. Compsoft says it is

working on a driver for the EGA and is considering including laser-printer drivers.

The program is run from a series of menus and function keys. I found the various methods of moving the cursor around the screen confusing. The machine used for the review was fitted with the new-style AT keyboard with a numeric keypad and separate cursor cluster; sometimes the program responded to the cursor cluster and sometimes it would only accept input from the numeric keypad.

Life is made even more complicated because in some of the sub-menus you move the cursor by pressing the space bar, while a cursor within a data chart can be moved only

MICROCHART PLUS				
VERDICT				
	POOR	AVERAGE	GOOD	EXCELLENT
Performance	<input type="checkbox"/>	<input checked="" type="checkbox"/>	<input type="checkbox"/>	<input type="checkbox"/>
Ease of use	<input type="checkbox"/>	<input checked="" type="checkbox"/>	<input type="checkbox"/>	<input type="checkbox"/>
Documentation	<input checked="" type="checkbox"/>	<input type="checkbox"/>	<input type="checkbox"/>	<input type="checkbox"/>
Value for money	<input type="checkbox"/>	<input checked="" type="checkbox"/>	<input type="checkbox"/>	<input type="checkbox"/>

A program that is badly in need of renovation.

by means of the shifted numeric keys, and in another instance the Tab key is used to move the cursor to the left. It was only after some practice that we got the hang of when to use which combination. The program accelerates training in this regard by the Pavlovian method of issuing a loud beep every time you hit the wrong key; it is very effective and you soon learn. Meanwhile we found ourselves wishing that Microchart supported a mouse.

From the main menu you can load both raw data and finished charts for editing. When you load data you are presented with a typical worksheet with letters across the top and numbers down the side. Once in the worksheet, the data can be edited by the user. As well as accepting data direct from the keyboard, Microchart can import data from a variety of standard business packages, including Lotus 1-2-3 and Multiplan. The



SPECIFICATION

Description: presentation-graphics program
Hardware required: IBM PC, PC/AT or compatible with 256K of RAM; Colour Graphics Adaptor, Hercules Graphics Card or higher; MS-DOS 2.10 or higher
Copy protection: none
Price: £145
Publisher: Praxis Software, 71 St. Johns Road, Tunbridge Wells, Kent TN4 9TR. Telephone: (0892) 42267
UK distributor: Compsoft, Compsoft Manor, Farncombe Hill, Godalming, Surrey GU7 2AR. Telephone: (0486) 25925
Available: now

program can also accept space- and comma-separated data.

Once the data has been fed in, you select the Graphs option to display the data on-screen. In order to display a graph, Microchart has to fetch two files from disc: one contains the data and the other the information required to generate the graph. We would have preferred to see the data appear when it is loaded in Graph mode, rather than having to call another command first, but the programmers in their wisdom decided against it.

At the bottom of the Graph screen is another grid, known as the Dataset. It is here that you select your options for the finished graph. You name each series in the Dataset key column, and in this menu you move from one row to the next by pressing Return. In addition to the Dataset key, each column has a default value which appears after each Return. The type of Graph chosen is displayed alongside the Dataset key. Possible types include all the usual formats such as scatter, pie, bar and line charts.

Other columns available from the Dataset menu allow the user to set the parameters for

Graphs Frame 1

		1986					
		Jan	Feb	Mar	Apr	May	Jun
SALES		128	125	122	138	148	145
Bought	Parts	68	68	45	48	36	31
Raw	Material	18	13	15	28	15	28
Process	Labour	3	4	8	8	18	11

Dataset Key	Type	Proc	Par	rom	to	St	DP
F1 D1	Bought Parts	BAR	S	1	1	RAW	0
F1 D2	Raw Materials	BAR	S	1	1	RAW	0
F1 D3	Process Labour	BAR	S	1	1	RAW	0
F1 D4	Assembly Labour	BAR	S	1	1	RAW	0
F1 D5	Factory Overhead	BAR	S	1	1	RAW	0
F1 D6							
F1 D7							
F1 D8							

F1 Undo F2 Ins Row F3 Del Row F4 Copy Row F5 Copy F6 Frame F7 View

The Dataset screen overlaid on a table of raw data.

CHART: V18L Graphs H Axis Scales Titles Format Notes Output MAIN 12854

		1986					
		Jan	Feb	Mar	Apr	May	Jun
SALES		128	125	122	138	148	145
Bought	Parts	68	68	45	48	36	31
Raw	Material	18	13	15	28	15	28
Process	Labour	3	4	8	8	18	11

title
F1 I1 'Costs - 000's
F1 I2
F1 I3 Month
title

chart SALES Data A:DEM COS F6 Frame F7 View

Setting up titles for one of the active frames.

the graphs. Thus the Process column asks you how the data is to be displayed: for example, you can choose to have the data shown in its raw form, or as cumulative or average totals. Likewise the Mode command asks you to specify whether you wish to have the data displayed in valued, stacked or ranged format.

The range of data to be charted is entered in the From and To columns of the worksheet. Once the cursor is within one of these columns you can mark a block of data by using the arrow keys on the numeric keypad to move around the background spreadsheet. Although this is an acceptable way of working, we would have liked to have had the option of entering the cell addresses directly. Whizzing around the spreadsheet is not always the easiest way of doing things.

The settings for the function keys are displayed at the bottom of the screen. Function-key assignments have been chosen to help speed up common activities. For example, once a row of settings has been chosen, pressing f2, the Ins Row key, duplicates the line on the next row down. This enables you to set the line and make any changes with the minimum of fuss.

Microchart can support two frames or charts in memory at once. The current frame is indicated on the far left of the Dataset menu by the label F1 or F2. Using the func-

tion keys, you can copy data from one frame to another and change the frame which you are currently working on. When all the data has been set, pressing f7 displays the graph.

In the View screen you can edit the graph further using a series of pull-down menus. The same menus are also available from the Data screen. As well as graph-editing functions they contain general functions, such as the facility to retrieve further charts and data from disc and return to the data menu.

The H-Axis menu sets the horizontal axis of the chart to record calendar months or plain numbers; it can also be left blank. Using the Scales menu allows you to set a pre-defined limit on the size of the chart, or leave it to be set automatically by the computer. The horizontal and vertical axes for each frame can be assigned a label or title in a sub-menu on the Data screen. Strangely enough, the main title of each graph is not set under this menu but under the Notes menu that is to be found further along the top bar.

It is the Format menu which has the most direct bearing on the chart, as it contains a large number of commands that alter the basic chart defaults and generally prettify the graph. From this menu you can set the styles of the graph — for example, by altering which kind of pattern is used to fill

the bars and pies. As is common with this kind of presentation-graphics program, a separate side menu shows examples of the various kinds of pattern that are available. An arrow superimposed on this menu can be moved around using the cursor keys to select the pattern you want. Once again we wished we had a mouse when using this facility.

The size of the text is also selected from the format menu. You scroll through a selection of sample type that is displayed in different sizes. We would have preferred to have been given a selection of point sizes, as this would have provided a more precise guide. You make a separate selection from the format menu for the font sizes used for the Dataset labels, titles, notes, etc. Sub-menus are also available to allow you to set the text in italics and to choose standard or bold styles for the lettering.

Microchart Plus appears not to have its own built-in print utility; instead it simply dumps the contents of the screen to the printer. Together with the lack of proper EGA support, this means that the resolution of its graphs is poor. As the prime purpose of a presentation-graphics package is to provide attractive illustrations of data, this is a serious defect. Even at maximum resolution the text is rough and jagged, and any attempt to jazz up the chart suffers because of it.

CONCLUSIONS

Microchart Plus is a mid-range presentation-graphics program aimed at the small to medium-sized business.

The program lacks a number of installation options that it should be possible to take for granted in a modern piece of software. The lack of support for up-to-date display formats affects the final result badly.

The program has a confusing number of ways of moving a cursor around the screen. On the new-style AT keyboard the package seems to have problems with its cursor-control functions.

While the package offers a wide range of options for creating different styles of graph, these features are vitiated by the poor quality of the final output, which is simply too rough to be acceptable in a modern presentation-graphics program.

Part of the printout generated from the data shown at the top of the page, reproduced actual size. Resolution is poor, even on the laser printer we used.

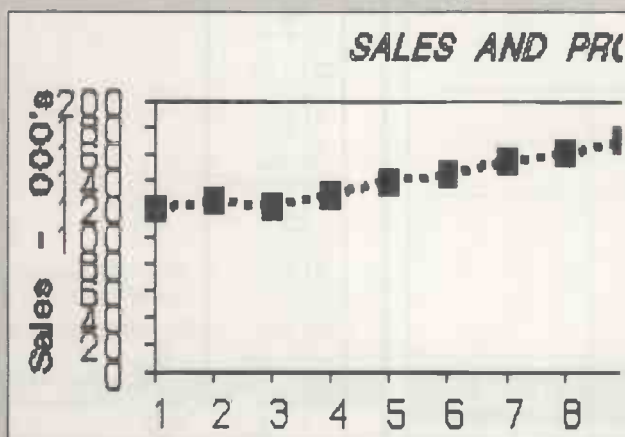

DISKS

DISKS

ACCUTRACK FLEXIBLE DISKS

Engineered for critical accuracy and reliability
by Dennison Magnetic Media.

top quality

certified 100% error free

lifetime warranty

post and packing free

why pay more?

Cash with order only. Please complete the order form
below and send it to:—

Moor House Marketing
Moor House, Ratcliffe Wharf Lane,
Forton, Preston PR3 0AN
or telephone 0524 792101 with Access Card No.

PC7	Per box of 10 disks			Amount	
	Prices				Qty
	1	2-9	10+		
5 1/4"					
48tpi SS/DD	10.95	10.45	9.95		
DS/DD	13.95	13.45	12.95		
96tpi SS/DD	13.95	13.45	12.95		
DS/DD	16.95	16.45	15.95		
HE (IBM-AT)	26.95	25.45	23.95		
3 1/2" SS	19.95	19.45	18.95		
3 1/2" DS	23.95	22.95	21.95		

Remember
post & packing
free

Total
VAT@ 15%
Payment

Name _____

Address _____

Access Card _____ Expiry _____

Number _____ Date _____

Signed _____ Date _____

DISKS

DISKS

DISKS

H-Graphics

Programmers Toolkit

for full

HERCULES GRAPHICS

support when using

BASICA
Pascal

GW BASIC
C

QuickBASIC
Clipper

IBM PC and Compatible Computers
fitted with Hercules Graphics card or compatible graphics cards

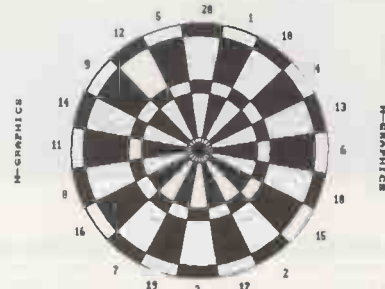

38 Graphics Functions for Selecting Graphics Pages,
Creating Windows, Drawing, Writing Text on the Graphics Screen
7 Different Text Styles plus Underlining and Inverse Video
Save and Load Screens to disk Versatile Screen Print facilities

"Easy Graphics" - PC User March 1987

£45.00 + VAT and postage

Send for brochure and review reprint

Laboratory Software Ltd.,
2 Ivy Lane, Broughton, Aylesbury,
Bucks HP22 5AP Tel. 0296 431234

LS

LS

→ circle 105 on enquiry card ←

SIMULTANEOUS**Data Transfer Control**
Between Computers & Peripherals

The **Peripheral Manager**
has a 256K Buffer, and will
store data for fast transfer
between all attached
devices.

The unrivalled flexibility of
the **Peripheral Manager**
is fully programmable.



Ports inter-connect with manual or software
control.

Pause channel controls data into and out from
the port.

Printer can give multi copies.

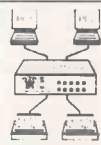

Centronic EPM1 Model
Four Ports 36 pin female

£395 + VAT
carriage paid

Serial/Centronic EPM2 Model
2 RS232 Serial Ports
(25 way female)

2 Centronics Ports (36 pin female) **£395** + VAT
carriage paid



**Each Peripheral Manager has a
comprehensive manual**

Ex-stock for immediate delivery

**HOMESTEAD DATA PRODUCTS LTD**

145 EDINBURGH AVENUE SLOUGH SL1 4UA
Ftx 107531 691037 Tlx 846086 CABLIN G

©1987

Tel: (0753) 691661

→ circle 104 on enquiry card ←

→ circle 106 on enquiry card ←

TASTM Database and Application Developer

Ready Made Applications

Two application suites are available from MEGATECH. TAS Modifiable Accounting and TAS Advanced Accounting. These were developed using the £199 TAS Plus Developer and this package is included in the price. But besides the database you also get the source code (that's the original database code the accounting systems were written in) and all other information and tools, including an excellent tutorial and reference manual. This allows you or your supplier to add modules or make changes to existing modules that will become your 100% accounting solution.

Modifiable Accounting £499

This includes the £199 TAS Plus Developer's version and consists of:

Nominal Ledger

3 years totals by month. Budgeting by month. Multiple departments/profit centres. Full VAT analysis for up to 10 rates of VAT. Post to previous periods and reclose. Financial statement writer. Up to 5 bank accounts. Detailed history files.

Purchase Ledger

Easy to enter invoices. Recall last nominal distribution. Pay invoices automatically or by hand. On-line account enquiry. Full supplier history and ageing reports. Real time updates.

Sales Ledger

Invoicing and sales analysis. Easy adjustments of current ledger entries. Statements, aged debt reports, bad debt letters, daybooks etc. define individual customer history.

Advanced Accounting £799

In addition to Modifiable Accounting you get three more modules:

Stock Control

Wholesale distribution-type. Regular and non-stock items. Average and last cost. Multiple selling prices. Easy stock adjustments. Month and year to date sales and costs. Post to individual nominal accounts. Full reporting.

Purchase Order Processing

Provides for regular and non-stock items. Automatic last cost check. Easy adjustments. Allows for part delivery, over/under shipments.

Sales Order Processing

No limit sales order entry with invoicing and backorders. Full salesman support. Unique price matrix "remembers" specials per individual customer. Picking slips. Easy adjustments and much much more.

System Requirements

TAS Plus runs on any IBM PC, XT, or AT compatible machine (including the AMSTRAD PC1512) with at least 384KB RAM and two floppy discs or a hard disc. A version for Concurrent CP/M with a different specification is also available. Ask MEGATECH for more information.

TAS Plus Database and Application Developer

The TAS Plus database and application developer is an invaluable tool for anyone requiring quick access to information. It allows you to enter, store, display, report and manipulate data, quickly, and easily and is suitable for both programmers and beginners.

Fast and Easy to learn

An excellent tutorial and reference manual teaches you step-by-step how to create your own applications using the TAS facilities. You start by "painting" the screen the way you want it and then the TAS Plus program generator writes the program for you. Producing reports is just as easy. When you have created your application, the database browser and report generator allow you to retrieve the information quickly and print it to screen, disc or printer. You will learn how to use the automated source code editor to add commands to your programs in order to produce professional menu-driven applications supporting multiple files, reports and screens that include pop-up menus and windows. Finally, when it comes down to the speed of developing and, more importantly, running your applications (because that's what you do every day) you will find that the compiled code makes TAS quicker than any other database.

Suitable for Most Applications

Use It for mailing lists and mailmerge applications, client records, stock systems, membership records, subscription accounting, and virtually any other application where you want to enter, store, display, report and manipulate data, quickly and efficiently. Our integrated financial accounting system is written in TAS (available with the TAS source code included) which proves conclusively that almost any database application can be produced with TAS.

At £99 TAS Plus is Complete

It consists of a Screen Painter, Program Generator, Database Browser, Report Generator, Command Language, Source Code Editor and Compiler. TAS Plus opens up to 16 files simultaneously where each file may have up to 16 key fields (through which you may locate a record) which are automatically kept in sorted order. Each file may have up to 65,000 records and each record may have an unlimited number of fields with up to 10,000 characters per record. TAS Plus supports excellent array handling, string manipulation and full arithmetic and bracketed expressions as well as time and (European) date arithmetic. Read and write non-TAS (ASCII) files and automatically convert to and from dBase 3 files. Use all IBM compatible colours and business graphics. User definable printer control characters, full function key access and control and more.

TAS Plus Developer £199

This is for those that need even more power and flexibility. Open 32 files, each

What the Press Says

"Combination of good, basic menu driven facilities with powerful programming tools make it excellent value for money, especially for novices wanting to learn, and developers wanting economical runtimes systems". (Personal Computer World)

"On a value for money basis, this must be one of the most attractive databases on the market". (Accountancy Magazine)

"TAS manages to pack plenty of power into its small price. It performed well in our tests and you can quickly write dense and efficient code for custom applications". (PC Magazine)

"There is no doubting that TAS is a very capable product—it handles serious-sized applications and does so with speed." (What Micro Magazine)

with up to 32 keys. Save up to 17 million records per file. It includes ext:2 commands and allows you to develop programs using an ASCII text editor. Study the developer source code of the browser, screen painter, program and report generator and the 120K command editor all of which were developed in TAS!

TAS Multi-User Version £349

The multi-user developer's version of TAS will work with IBM PC Network, Novell Advanced Netware, Torus Netware, 3-Com Netware, Transnet, D-Link, Multilink Advanced, MS-Net (Apricot Xen-I) and all other MS-DOS 3.1 NETBIOS compatible networks.

30-Day Money Back Guarantee

The package you receive contains a sealed unsealed set of floppy disks. The unsealed set is fully operational but can only save a limited number of records. This allows you to use the complete working system at your leisure. If you find that TAS does not perform in accordance with our claims and provided that the sealed set remains unopened and all goods are returned to us (in a good condition) within 30 days of purchase, we will refund your purchase price less handling and a 10% restocking charge.

Order Your Copy Today



NOT COPY PROTECTED

Please send me the following items

More information: _____

TAS Plus @ £99: _____

TAS Plus Developer @ £199: _____

TAS Plus Modifiable Accounts @ £499: _____

TAS Plus Advanced Accounting @ £799: _____

Add handling & shipping @ £6: _____

Add 15% VAT: _____

I enclose a total of: _____

Payment: Cheque Access Visa

Card Number: _____

Card Expiry Date: _____

Card Name: _____

Card Address: _____

Postcode: _____

Daytime Tel. No.: _____

Signature: _____ PCI7187

A VAT invoice will be included in the parcel. Enclose a company letterhead if invoice name and address need to be different from card name and address

MEGATECH
CORPORATION

111-113 Wandsworth High Street
London SW18 4HY
Telephone: 01-874 6511. Telex: 21768

PC-SIG LIBRARY

Now over 700 Disks

Only £6 per disk
special introductory offer all disks
£5. Offer ends June 30.

**Finally software you don't have
to be rich to own**

We're ISD, UK's Sole Authorised Distributor for PC-SIG. We offer the world's largest library of public domain and user supported software, (whose authors request a donation from satisfied users) For £6 per disk, you buy software that has been selected from leading authors, thoroughly analysed and professionally supported.

UTILITIES

- 66 GINACO54 polished routines written in basic for any beginner or experts.
- 133 ULTRA-UTILITIES 4.0 recover lost files, modify sectors, etc.
- 245 ULTRA-UTILITIES FILES UNSQUEEZED.
- 405 PC-DESKMATES Better than all of the rest of the memory resident desktop utilities.
- 273 BEST UTILITIES All of the most requested utilities on one disk.
- 478 HARD DISK UTILITIES A collection of the best in the library.
- 414 UNPROTECT Various routines to disconnect protection schemes.
- 376 PATCHES make back up copies of some of the most popular commercial programmes with this collection.
- 507 PC-SPRINT Software and instruction on how to cheaply speed up your system 2-3 times.

EDUCATION

- 403 PC-TUTORIAL A great introduction to DOS.
- 105 PC-PROFESSOR Learn Basic the easy way. One of the best tutorials on BASIC.
- 254 PC-DOS HELP type "help" for the DOS command you forgot.
- 320 TOUCH-TYPE Advanced type tutor.

WORD PROCESSORS

- 78 PC-Write 2.4 a fully featured word processor.
- 415 W-ED LETTERWRITER Word Processor - editor. Controls letter processing.
- 480 PC-OUTLINE Outline and organise information, much like Thinktank.

DATABASE PROGRAMMES

- 5 PC FILE III most popular database program.
- 398 ESIE EXPERT SYSTEM Artificial intelligence shell to build a custom knowledge-base.
- 503 RELIANCE MAILING LIST Keeps track of multiple lists, sorts and prints by specific group - good for custom mailing.

FINANCIAL PROGRAMMES

- 423 PROJECT MANAGEMENT handles over 1,000 tasks with CPM
- 430-431-432 ANALYTICALC DISKS (3) Complete spreadsheet, database, graphics, word processor- fast!

COMMUNICATIONS

- 212-334-621-622 RBBS 14.1 A bulletin board classic. (4 disks)
- 310 QMODEM the fastest communications programs you can buy at any price.
- 499 PROCOMM Communications with XMODEM, KERMIT, ASCII protocols, supports, IBM-3101, DEC VT52/100, ADM-3 and ANSI.

MANY GAMES AVAILABLE
DEALER ENQUIRIES WELCOME

GRAPHICS

- 344-345 PC-KEY DRAW A Colour Graphics system. Lots of demonstration files.
- 418 PC-GRAPH Allows user to create graphics from PC-File report files.

MATHS AND STATISTICS

- 88 EPISTAT 3.0 Statistical analysis of small to medium-sized data samples.
- 654 655 Kwikstat Grphac Orientated programme for scientific statistical analysis.

LANGUAGES

- 148 XLISP 1.4 Lisp language interpreter.
- 417 PROLOG VERSION 1.9 Complete with editor and documentation.
- 409, 410 SNOCREST BASIC two disk set. Real basic interpreter. Can be used with a multi-user system.
- 424 PASCAL COMPILER Written in Turbo Pascal.
- 510 VISIBLE PASCAL COMPILER Learn to programme PASCAL

SPREADSHEETS

- 199 PC-CALC Fabulous 123 work-a-like from the author of PC-File.
- 406 FINANCIAL PROGRAM Lotus worksheet
- 301-303 Lotus financial and budgeting applications (3 disk set)

LATEST ADDITIONS

- 522 INSTANT RECALL memory resident programme that stores and retrieves a wealth of information.
- 523 SIDE WRITER Print your large spreadsheets sideways on the printer.
- 528 NEW YORK WORD The most powerful wordprocessor we have; all the standard features plus automatic indexing, table of contents and foot-noting.
- 568 PC-PROMPT Memory resident helper for DOS command and syntax.
- 576 PC-TICKLE The perfect reminder for appointments and 'thing to do' list.
- 577, 578 C TUTOR Perfect for those wanting to programme in C.
- 579, 580 PASCAL TUTOR Learn to programme in PASCAL in the convenience of your own home.
- 598 DISKTOOL Like Norton's; recover erased files, or fix damaged files.
- 608 AUTOMENU Create professional menus, without all the hassle.
- 611 BLACKBEARD The programmer's editor for writing code in PASCAL, C, or FORTRAN.

QUICK START EVERYTHING FOR THE NEW USER, includes

CATALOGUE LISTING OVER 600 DISKS
403 COMPUTER TUTOR 5 PC FILE III
78 PC WRITE 273 BEST UTILITIES
199 PC CALC 476 PATRICK'S BEST
406 DESK TEAM GAMES
£70 VALUE - ONLY £40
10 DISKS - £50

STOP!

WE'VE GOT THE PRICES YOU NEED!

WHY PAY MORE?

CLIPPER	352	RRP 595
DATAEASE	385	RRP 545
DBASE II	265	RRP 395
DBASE III PLUS	339	RRP 595
DELTA 4 PRO	365	RRP 545
FRAMEWORK II	325	RRP 550
FREELANCE PLUS	249	RRP 395
GENIFFER 3	219	RRP 295
JAVELIN	166	RRP 245
LOTUS 1-2-3 2.01	235	RRP 395
LOTUS MANUSCRIPT	249	RRP 395
MS MOUSE	125	RRP 175
MS WORD 3.1	239	RRP 425
MULTIMATE	194	RRP 395
MULTIMATE ADV	259	RRP 495
PARADOX	325	RRP 550
QUICKSILVER	299	RRP 460
RAPID FILE	200	RRP 275
SAMNA IV	371	RRP 550
SMART 3.1	365	RRP 695
SUPERCALC 4	199	RRP 396
SUPERPROJECT PLUS	255	RRP 495
SYMPHONY 1.2	335	RRP 550
TURBO BASIC	55	RRP 70
WORD PERFECT 4.2	249	RRP 425
WORDCRAFT 3	309	RRP 475
WORDSTAR 2000 PLUS	275	RRP 549
WORDSTAR 2000 2.0	224	RRP 465
WORDSTAR PRO 4.0	193	RRP 399
XCHANGE	235	RRP 495

- This is a small selection - call for details!
- Fast delivery!
- Friendly professional service!
- Credit accounts available!
- Government/export orders welcomed!

0480 · 53044/413122

Elite Computer Systems

UNIT 2 · HALCYON COURT · ST MARGARET'S WAY
HUNTINGDON · CAMBS PE18 6DG

Prices shown are for IBM/compatibles. All prices subject to carriage and VAT and are correct at time of going to press

QTY	DESCRIPTION	PRICE	VALUE
	DISKS		
	QUICK START	40.00	
	SHIPPING		2 00
	SUB TOT		
	VAT		
	TOTAL		

PC-SIG
AUTHORIZED
DEALER

ISD INTERNATIONAL
SOFTWARE DISTRIBUTORS Ltd.
P.O. Box 872, Sutton Coldfield,
West Midlands, B75 6UP
Telephone: 021-378 2229

USER GROUP ENQUIRIES
WELCOME

MEMBERSHIP AVAILABLE

0008

ADMICRA

An  Company

AMSTRAD

Tandon

ATARI

Roland

AUTOCAD

MANNESMANN TALLY

TAXAN

AMSTRAD

PC1512 from £449 inc. Free 640K Upgrade

Opus

Authorised Dealer from £499

PCX & PCA SUPPLIED WITH 12 MONTHS FREE ON-SITE MAINTENANCE

BASIC AUTOCAD SYSTEM

Opus System 4 (20MB, IBM RAM) 720 x 348 resolution mono parallel serial ports. Basic Autocad. Summarmouse, Hitachi A3 plotter

£1799

ADVANCED AUTOCAD SYSTEM

PCA20 (20MB, 1MB RAM) 720 x 348 resolution on 14" screen 1 parallel & 2 serial ports Autocad plus ADE 2 & 3. Cherry A3 digitiser Roland DPX2000 A2 plotter and stand

£6599

We can tailor Autocad systems to your requirements due to our extremely wide range of support peripherals (see below) Installation and training - independent consultancy service available. Please call for details.

VIKING ULTRA HIGH REVOLUTION 19" DISPLAY - Ideal for Desk Top Publishing & CAD. Please call.

ALLOY MULTI-USER Turn your XT/AT into a Novell compatible multi-user system from **£1199 per station**

1040 ST

£559

HARD DISK & MEMORY UPGRADES

IBM & Compatibles 20MB.....	£359
IBM & Compatibles 30MB Hardcard.....	£379
Sanyo Memory upgrade to 256K + RAM disk + 25% extra disk capacity.....	£65
Amstrad PC 1512 upgrade to 640K.....	£29

APRICOT ADDS ONS

512K Memory Board.....	£115
20MB Hard Disk Upgrade.....	£65
Hi-Res Monitor for Portable.....	£109

PRINTER PROMOTIONS

Panasonic 1081.....	£169
MP 165.....	£189
Star NL 10.....	£215
Epson LX800.....	£219
Epson FX800/1000.....	£319/£399
M. Tally MT85/86.....	£299/£399
Epson EX800/1000.....	£399/£539
NEC P6/P7.....	£409/£499
Epson LQ800/1000.....	£459/£619
Juki 6100.....	£259
Quendata 1120.....	£169
HP Laserjet.....	£2195

SHEETFEEDERS Please Call

ACOUSTIC HOODS Please Call

PRINTER BUFFERS

Serial/parallel In/out 8K-2MB from.....£79
*New * All Purpose X-buffer - Please Call

FANFOLD PAPER All sizes available

11" x 9 1/4" 60gm.....	£9.75 (2000 sheets)
12" x 9 1/4" 60gm.....	£3.99 (2000 sheets)
A4 Clean Edge-70gm.....	£15.95 (2000 sheets)*
Edge - 85gm.....	£9.30 (1000 sheets)
11" x 14 1/2" 60gm.....	£13.50 (2000 sheets)*
Delivery £2.65 (fixed) - £1 per box	
Extra £1 per order for items marked*	

LABELS 70mm x 36mm.....£2.95 1000

89mm x 36mm.....from £3.25 1000
Please call for other sizes.

RIBBONS for all printers eg

EPSON FX, MX, RX 80/100.....	£2.49/£3.75
EPSON LX 80.....	£2.95
JUKI 6100 single strike.....	£1.15
SHINGWA/M TALLY MT80.....	£3.79
KAGA/CANON.....	£3.99
QUME MS4.....	£2.65
APPLE IMAGEWRITER.....	£3.35

Multitech 910 Small footprint 80286, 10Mhz 20MB monographics IP &25. Superb value **£1395**

PRINTWHEELS from.....£3.75

Delivery 95p Quantity ribbons/printwheels

SOFTWARE SPECIALS

Ventura DTP.....	£695
Supercalc 4 Lotus Eater.....	£195
VP Planner Lotus Clone.....	£65
VP Info.....	£65
Perfect Writer 2.....	£99
Wordstar 3.0 (IBM).....	£349
Wordstar 2000.....	£225
Wordstar Prof 4.....	£229
Word Perfect.....	£265
Turbo Pascal (8087 + BCD).....	£55
Turbo Reflex.....	£79
CADpower.....	£259
Turbocad.....	£299
CADD inc. mouse.....	£169
Autosketch.....	£79
Ability-Integrated Package.....	£79
Moneypower.....	£79
Sage Financial Controller.....	£249

PLOTTERS - DIGITISERS etc.

Hitachi 672 A3.....	£449
Roland 880A A3.....	*£679
Roland 885 A3.....	£929
Roland DPX2000 A2.....	**£2495
Hewlett Packard 7570A A1.....	£4495
Graphtec GP9001 AD.....	£6,195
Summasketch 12" x 12" digitiser.....	£395
Cherry A3 digitiser.....	£495
Logimouse Plus.....	£85
Summarmouse with GEM + Write & Paint (IBM).....	£179
*inc FREE 11k buffer *Inc stand	

DISKS - POST FREE Packed in tens No quibble guarantee

Prices for ONE box. 10% EXTRA DISCOUNT for each extra box.

5 1/4"	DYSAN	SONY	P'SION
SSDD	£13.40	£11.90	£8.90
DSDD	£16.90*	£14.90	£10.90
DSQD	£23.90	£17.90	£13.90
HD 1.6MB	£29.90	£27.90	-

***DYSAN DSDD - 1 EXTRA DISK PLUS LIBRARY CASE**

SONY 3.5" SS £16.90 DS £23.90
AMSOFT 3" £28.90

SONY PLAIN LABEL UNBOXED - Please deduct £2

LOCKABLE 40 3 1/2 DISKS.....£7.95

DISKS BOXES 70 5 1/4 DISKS.....£9.95

Official Government/Educations Authority orders welcomed.

Please add 15% VAT to all prices (inc. carriage) Limited space precludes listing of our full range of products. Please telephone if you do not see the item you require.

ADVANCED MICROCOMPUTER APPLICATIONS LTD, 1ST/2ND FLOORS
40 HIGH ROAD, BEESTON, NOTTINGHAM NG9 2JP. Tel: 0602 25262

FOR VALUE

Born Leader.

With daisy wheel heritage and second generation laser technology the Qume Laser TEN sets a new standard in clarity.

When Laser TEN first saw the light of day last year it had a formidable family reputation to live up to: Qume's world supremacy in letter quality printing.

In fact, it is this heritage which has given Laser TEN the edge over competition in the office. All founts are modelled on daisy wheel type faces, subtly refined to adapt them to laser technology.

The clean impression created by the characters is highlighted by the brightness on the page: no fine deposits of toner over the paper which so often makes a laser printed page look as though it has been photocopied.

As a result, there are only two ways whereby readers of a letter printed by Laser TEN can distinguish it from typewritten



material — with a magnifying glass or by touch.

Laser TEN fits in with your office computer system as simply as a daisy wheel printer, too: and it will continue to be compatible even if you change your system. You just need to plug in the appropriate interface.

The type founts are plug-in modules, too. And all the replaceable elements — toner, developer and drum — are easily recharged by the operator. All of which makes our quiet, ten-page-a-minute model very comfortable to live with.

So if you want state of the art laser performance with daisy wheel distinctiveness, there's only one machine which has the breeding. Laser TEN from Qume.

Qume.

Qume Quality. Leadership is just a part of it.

Marketing and Sales Qume House, Park Way, Newbury, Berkshire RG13 1EE Telephone: (0635) 31400 Telex: 846321 Telefax: (0635) 32852
Service and Training Centre Bridgewater Close, Reading, Berkshire RG3 1JT Telephone: (0734) 584646 Telex: 849706

WORDSTAR PROFESSIONAL 4.0

OLD-TIMER

By Susan Curran

Unlike its other recent packages, Micropro's latest release retains the character that users of the original WordStar have learned to love — or hate.

Only two or three years ago WordStar was indisputably the leading business word processor, with a massive installed user base and a high reputation. In those days it looked virtually unassailable — too well entrenched ever to be replaced by different programs. Now things are different. Micropro has been proved wrong in believing that established WordStar users would graduate automatically to its newer and quite different programs, WordStar 2000 and Easy.

While the original WordStar languished without a real update for years, Microsoft Word, Word Perfect, Multimate and several other programs all forged ahead. And rightly so: the newcomers are more powerful and easier to use. By last year, only the ignorant, or existing WordStar users too scared to tackle learning a second program, were buying WordStar.

Now Micropro has changed tack and produced WordStar 4.0, which is a proper update of the real WordStar. It includes several features that have been lifted straight from New Word, the WordStar clone which Micropro recently bought. There are also a number of other new features designed to bring the program back into serious contention for the top spot in the word-processor market.

The Professional version of WordStar 4.0 includes mail-merging and a combined spelling checker and thesaurus. It comes on six unprotected floppy discs, including tutorial and installation discs, with a newly written manual. WordStar manuals were once a byword for unreadability, and though they have improved over the years this one is still barely up to par. The text is clear enough, but the layout is cramped and it is not easy to find topics quickly. It is spiral bound with soft covers and does not look particularly durable.

Like the versions which have gone before, the new WordStar powers-up with a main menu and disc directory. The rather scrappy layout is unchanged: the directory, though alphabetical, does not give dates of file creation, let alone any more expansive details. Also, you have to type the name of a file in



SPECIFICATION

Description: word processor with spelling checker, thesaurus and mail-merge

Hardware required: IBM PC, PC/AT or compatible with at least 256K RAM; 320K needed to use thesaurus

Copy protection: none

Price: £399

Publisher: Micropro International, Haygarth House, 28/31 High Street, London SW19 5BY. Telephone: 01-879 1122

Available: now

full in order to access, copy or delete it. In no way does this rate as a proper file-management facility. The main menu is not accessible while a document is being edited — though many features on it are — and you have to save a document and exit from it before printing any or all of it.

The editing screen has the familiar help menus at the top; they can be suppressed, or called up only when required. There is also full in-context help on a range of commands. Certain commands are available from the function keys, and you can reassign function keys from their defaults if you wish. A function-key menu at the bottom of the screen lists two alternate functions for each key. This menu can be suppressed, but only through the installation program. When both of the menus are on-screen — as

they are by default — no less than 13 lines of the screen are taken up by system information, leaving only 11 lines for the text window. There is also a column of code symbols down the side of the screen. Some permanent on-screen help is reasonable enough, but does anybody really want this much?

As before, WordStar defaults to reproducing all printer-control key sequences on-screen: for example, underlining is marked by a ^S before and after the text, as well as by proper underlining on-screen. You can suppress the control codes to view the final layout, but when the codes are unsuppressed they do clutter the screen, as do the dot commands that define many aspects of document layout. WordStar is still far from a clean-screen program.

Margins can now be amended by dot commands that become part of the text file. Thus

.LM 10

sets the left margin at column 10. As an alternative you can use Control-O menu commands, which change the current ruler settings but leave no other trace in the file. There is even a third method of changing format, lifted from New Word, in which you embed ruler lines in the text. This option alone would have been reasonably satisfactory, but giving users three choices — which work quite differently from each other and in ways which interact awkwardly — invites confusion for old and new users

(continued on page 69)



PROBLEM? How do you transfer your valuable data files between PC's of a different type and/or drive size?

SOLUTION! PLUS-FD: A family of 3", 3.5" or 5.25" external floppy drives that make transfer of files between PC's as simple as inserting a floppy diskette!

IMAGINE ★ A 5.25" IBM drive on your APRICOT or VICTOR 9000 ★ A 3.5" APRICOT drive on your IBM PC or compatible.

PLUS-FD



PLUS-FD is supplied cased, with power supply, driver and formatting software. Prices from:.....£99.00

PC UPGRADES



YOUR PC

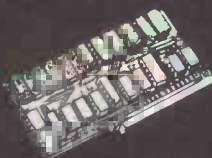

RAM BOARD



INTEGRAL HARD DISC

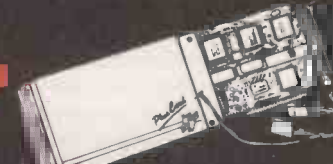

PLUS CARD

FOR THE IBM PC/AT & COMPATIBLES:
PlusCard - 20Mb and 30Mb Plug-In Hard Disc.
A 3.5" hard disc on a card that is simply installed in your PC expansion slot. Integral Hard Disc - 5.25" hard disc in 10Mb to 150Mb.
Prices from £395.00

FOR THE APRICOT RANGE:
3.5" 20Mb Internal Fixed Disc. Prices from £595.00

Single-board RAM running at full processor speed.
256k£115
512k£130

MASS STORAGE SUB SYSTEMS

FIXED DISCS: Our external Fixed Discs are available in a range of capacities from 10Mb to 260Mb.
REMOVABLE HARD DISC CARTRIDGE: Solve your data integrity problems by locking your hard disc away at night. Available in 10Mb or 20Mb options, the removable hard disc cartridge uses the same technology as the fixed disc and can be used both as fast back-up and additional on-line storage.
TAPE STREAMERS: Capacities up to 45Mb. Our high speed tape drives will back-up 10Mb in only two minutes.
COMBINATIONS: Fixed Disc units are available in a combination unit, either with a removable hard disc cartridge or tape streamer.
PRICES FROM:..... £850.00

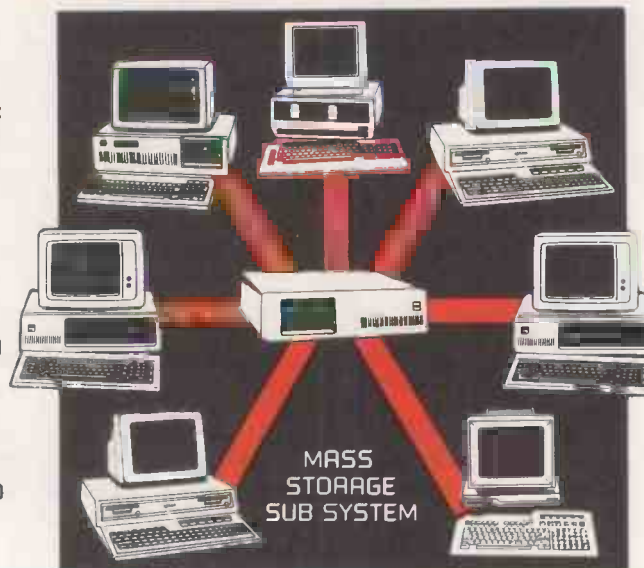

PlusNet

POWERFUL: PlusNet enables up to 7 PC's of the same or differing types to access/share the data on the same hard disc subsystem.
SIMPLE: For existing Users of a PLUS 5 subsystem, upgrading to PlusNet could not be easier. PlusNet supports single-user software and no additional memory is necessary.
COMPATIBLE: PlusNet supports most PC's running under MS DOS.
PRICE PER MACHINE:..... £350.00
All PLUS 5 Products are covered by a 12 month parts and labour warranty.
Optional ON-SITE MAINTENANCE from PLUS 5 is available. (Prices on application). Prices are subject to VAT.

Available from:

PLUS 5 ENGINEERING LIMITED

Crowborough Hill, Crowborough, Sussex TN6 2EG. Tel: (08926) 63211/Telex 95538 PLUS G

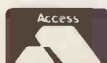

Mail and Telephone Orders welcome.

— circle 110 on enquiry card —

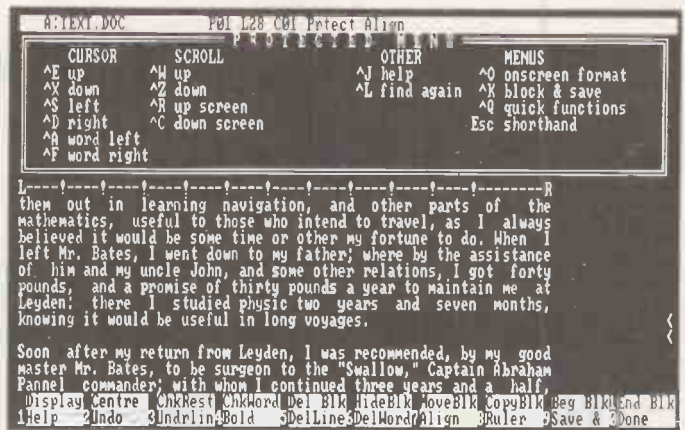
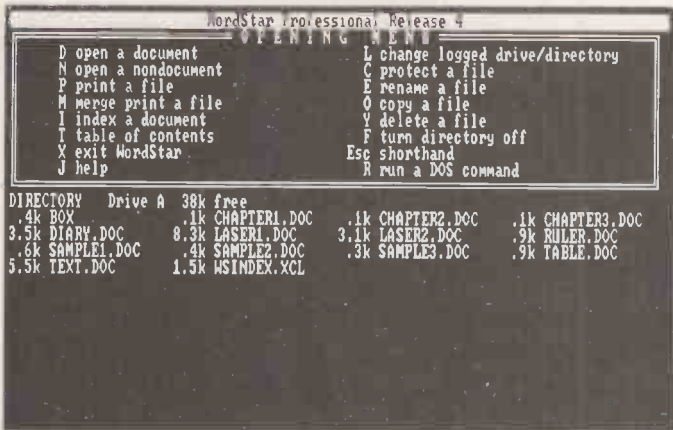

(continued from page 67)

alike. To make matters worse, the options are not well explained in the manual.

Justification and line spacing are echoed on-screen, but WordStar still does not reformat automatically after editing changes. The manual reformats tend to be slow, even when the only change is to line spacing.

The old Control-C indent command is still there, but there is now also a decent dot command to handle indents and reverse indents — that is, paragraphs where all but the first line is indented. Another welcome import from New Word is an Undo command which restores deleted text as well as cancelling unwanted commands. However, it does not nest deletions, and will not recover those done with the Delete key.

Most of the basic WordStar editing tools have been retained. They include a Search and Replace with many options, and some of the old limitations removed. There is also a block Move/Copy/Delete and columnar features. Among the general enhancements are equation solving and some other maths features, line and box drawing, and a limited set of commands for drawing up an index or a table of contents. WordStar Professional 4.0 does not incorporate the full Star Index package. You can now get a word count, but only by running a utility routine from the main menu.

Among the obvious omissions are automatic footnote handling, outlining and automatic paragraph numbering, and flush-right alignment of text. More drastically, WordStar still has absolutely no multiple-document capability, let alone windowing. In this it is a whole era behind Microsoft Word and Word Perfect.

At least there is now a macro capability, called "shorthand" in WordStar parlance. Up to 36 macros can be defined, and by a rather complex procedure they can be made to include commands. They can only be up to 80 characters long — which is a severe restriction — and cannot include Carriage Returns. So, for example, to define an address as a macro you have to nest a whole raft of macros inside each other.

Printer support is improved, but it remains far below the level of the best programs. Though there is an expanded range of printer drivers it is still no more than barely satisfactory. Full details of the printer drivers are contained only in a Readme file

WordStar powers-up with the opening menu (left). The default editing screen (right) displays function-key assignments along with old-style help information.



on disc, which is annoying. No substantial steps have been taken towards handling different-sized fonts, nor is there anything else which moves the program on in the direction of desk-top publishing.

It is possible to install a single copy of the program to handle two different printer ports, and the customising procedures have been improved considerably. By using dot commands you can now define printer-control sequences within document files, as well as more generally, so it is no longer a massive task to access different control features on a dot-matrix or laser printer. You can also merge print as a background feature, but there is no print-queue management.

The spelling checker has an 87,000-word dictionary. It works in-context and will check whole documents or single words. Its suggested corrections are generally sensible, though they are a little slow to appear. My only real criticism is that the various choices — for example, Ignore Throughout Document, Add to Dictionary — have letter designators that are spread all over the keyboard, so you cannot keep your fingers on them, ready to react. There is a single user-defined dictionary, but no easy way of creating alternative ones.

WordStar 4.0 now also has an impressive memory-resident thesaurus, called Word Finder. There are two synonym files, with 120,000 and 220,000 words, to allow for different RAM sizes. A wide range of alternatives is produced for words that you look

up. They are separated according to alternative meanings, so you can browse from entry to entry. Word Finder saves your browse path, and you can backtrack up to 10 steps at a time.

The final feature of the Professional package is the mail-merge. It will be familiar to users of WordStar Professional, though it has been slightly enhanced for this release. WordStar names fields in its outline file but not in its data file, which is laid out in a simple free-format way with no templates at all. It is possible to skip and reuse data from different fields, to include conditional sections and to obtain keyboard input. You can also select records on If criteria, though this feature is not particularly well developed. All in all, the mail-merging is perfectly adequate, though not outstanding.

WordStar Professional 4.0 is certainly a massive advance on version 3.3, but Micropro still has a problem. The philosophy behind WordStar is outdated now, and even substantial surface developments cannot altogether hide the fact that this program belongs to the days when not all PCs even had cursor keys, let alone 10 or more function keys.

But WordStar will only be WordStar and retain its user loyalty for as long as it keeps all its ghastly old features such as the diamond of alphabet keys that move the cursor, the messy nested menus and the control-key command combinations. They do not always sit comfortably with the new enhancements, and because there are now both old and new ways of doing many things, WordStar has become even more difficult to learn than before.

CONCLUSIONS

■ WordStar 4.0 is a very real advance on version 3.3, and for committed WordStar users it could be worth buying.

■ The basic WordStar concepts are now outdated, and at times this version's updated functions sit awkwardly with their original equivalents. As a result, the program is not easy to learn.

■ There is still no windowing and no dual-document capability, and a few holes remain in the command structure. There is also very little support for advanced hardware.

■ Though adequate, WordStar Professional 4.0 is not an outstanding program by top-level standards. **PC**

RAPID FILE OFF-THE-PEG DATABASE

By Mike Lewis

While dBase is still the standard full-blown database package, Ashton-Tate is complementing it with a ready-to-go filing program more suitable for the occasional user.

Ashton-Tate's Rapid File is a filing program that manages to avoid the complexities of a full database system, while still providing something beyond a simplistic cardbox-type package. It deals strictly with one file at a time, and is aimed squarely at the new or occasional user. However, it has enough power to cope with some fairly demanding applications. It is also very neatly packaged, with an unusually good user interface.

Its most striking feature is that it looks more like a spreadsheet than a database. It works by holding data in the form of a table, with rows corresponding to records and columns corresponding to fields. Setting up a file is simply a matter of typing new column headings. To add a new record you just enter data in the next free row.

Rapid File's designers clearly understand that the spreadsheet concept is easily learned, and have borrowed a lot of ideas from this area. Thus you can move a pointer from cell to cell, change column widths and formats, enter formulae into cells and so on.

In fact you can go further by making Rapid File closely mimic the user interface of Lotus 1-2-3. By default, Rapid File's operations are controlled by pull-down menus. But they can be replaced by a Lotus-style top-line menu in which many of the commands are identical to those of 1-2-3. For example, /FR will retrieve a file in both packages. Even the function keys are similar, with f2, for instance, being used to edit a cell.



RAPID FILE				
PC VERDICT				
	POOR	AVERAGE	GOOD	EXCELLENT
Performance	<input type="checkbox"/>	<input type="checkbox"/>	<input checked="" type="checkbox"/>	<input type="checkbox"/>
Ease of use	<input type="checkbox"/>	<input type="checkbox"/>	<input type="checkbox"/>	<input checked="" type="checkbox"/>
Documentation	<input type="checkbox"/>	<input type="checkbox"/>	<input checked="" type="checkbox"/>	<input type="checkbox"/>
Value for money	<input type="checkbox"/>	<input type="checkbox"/>	<input checked="" type="checkbox"/>	<input type="checkbox"/>

Spreadsheet techniques applied to a database program make Rapid File a very effective tool.

One implication of this is that fields do not have to be of fixed length. The amount of data visible at any time depends on the width of its column, which can be altered at will. The actual entry and editing of data is carried out in a window at the foot of the screen. The result is a more efficient use of disc space, especially where the contents of fields are highly variable.

By the same token, fields do not need to have rigid data types. You can specify that a column is to contain text, numbers or dates, but this is an aid to formatting rather than a way of controlling the file's contents. There is nothing stopping you entering, say, the word "nil" in an otherwise numeric field.

Format options include the usual currency or accounting styles for numeric data, and European or American for dates. A less common feature, which could be useful for displaying long blocks of text, is the ability to alter the height of a cell as well as its width. None of these formatting options actually modifies the data, only the way the user views it.

As well as the various ways of changing the appearance of data, Rapid File provides a number of options for sorting and selection. You can sort the file simply by entering the sort keys in a special form, called from the menu. The file can be sorted on any number of fields, in any combination of ascending and descending.

Similarly, you can apply selection criteria to the file. Again, this is done by entering the details in a form. When you return to the main table, the up and down arrow keys move the cell pointer only to the selected records. More usefully, you can hide all non-selected records, or perform global changes and deletions on the selected ones.

Alternatively, you can manually tag any record by moving the pointer to the record and pressing f5. This is useful where the user knows which records are to be selected but cannot easily express the reasons for the selection as formal criteria.

One of Rapid File's strongest features is its reporting. There are three ways of producing reports. The easiest is a straight listing of the table, invoked directly from the print menu. Even this simple printout can be customised to a large extent, since it always reflects the current layout, including format settings, column widths and selection criteria.

The second report format is the quick report. This requires a little more effort, since the layout has to be specified in some detail. It is essentially a columnar listing, with optional totalling and subtotalling on groups of records.

Finally, there is the custom report, which is similar in concept but gives much greater flexibility in the arrangement of fields and text. Further customisation is possible via an option menu, which is used to specify margins, titles, headers, footers, page

(continued on next page)

SPECIFICATION

Description: filing system
Hardware required: IBM PC, PC/AT or compatible with 384K RAM
Copy protection: none
Price: £275
Publisher: Ashton-Tate, 1 Bath Road, Maidenhead, Berkshire SL6 1UM. Telephone: (0628) 33123
UK distributors: all major distributors and dealers
Available: now

(continued from previous page)

lengths, and spacing between records. It can also send Escape sequences prior to printing. Once set, these options apply to all three types of report.

However, there is more to Rapid File's reporting than just producing printouts. When you design a quick or custom report you are not merely working with an abstract layout, but rather with an instance of an actual report, based on the current values in the file. You can browse through the design and alter the underlying values. The important point is that such changes are reflected in the original file. This means that reports can be used to provide different ways of viewing and working with a file. It is this which gives Rapid File much of its power.

You can take this idea a step further by combining data with a text file which has been created with Rapid File's memo writer. The memo writer is a reasonably serviceable word processor that has two specific uses within Rapid File. One of them is to stretch an ordinary cell beyond its usual limit of 254 characters. If you press f4 while you are editing a cell, Rapid File moves its contents to a text file and invokes the memo writer. You can now enter further text, to a limit of 64K. When you leave the memo writer the file is linked to the original cell. It is a bit like the memo field in dBase III, except that here the memos are used as and when needed, rather than for all instances of a given field.

The memo writer's other use is to create

File	Layout	Records	Write	Print	09 36 am
	Surname	Initials	Department	Experience	
1	Young	A.R.	Engineering	5 years electronic eng., 3 months supervisory Trainee	
2	Brian	R.J.	Advertising		
3	Roberts	L.	Accounts	2 yrs as bookkeeper in previous employment	
4	Charles	J.	Legal	Qualified solicitor	
5	Stanton	A.	Accounts	not known	

TABLE: Unsaved layout || C:\STAFF.RPD || Selected: 5 of 5 ||

Rapid File's spreadsheet-like data table can be printed out as a report.

mail-merge documents. This involves inserting variable fields into fixed text. As with the reporting functions, you work with the actual data from the currently selected records. You can create a stack of, say, personalised letters, then flip through them on the screen, adjusting the contents of individual letters prior to printing. Very few WP or mail-merge packages give this degree of fine tuning. The memo writer can also be invoked directly from the DOS prompt and used independently of the main filing system.

Rapid File supports keyboard macros, import and export, and extensive customisation. You can transfer files to and from

dBase, 1-2-3 and the PFS family, and from several other packages via the comma-delimited format. The customiser allows you to alter the appearance and colours of the screen, the initial memo writer settings, the printer defaults and quite a lot more.

CONCLUSIONS

■ Rapid File is a filing system of medium complexity. It sits about halfway between the simple flat filers and the heavyweight databases.

■ It should meet the filing and reporting needs of all but the most demanding user.

■ The user interface is especially good. A first-time user should have little difficulty getting to grips with this program.



Industrial P.C. Enclosures

New rack mount PC's chassis are now available with three types of power supply, capacity for up to four disk drive and both XT and AT type rear panels. Specify what disk drives are needed and we can fit them too. For the Industrial OEM and End User we can provide P.C. components to interface with most industrial or scientific peripherals, such as high speed tape backup units, multi-user adapters, analogue to digital converters and digital to analogue converters.



Sirton
computer systems

Sirton Computer Systems Limited

7 Greenlea Park, Prince George's Road,
London, SW19 2PT
Tel: 01-640 6931
Telex: 269534 SIRTON G

All items are backed up by our technical support and an ability to assemble systems or units to customer's specific requirements. We also offer a full software advisory service with emphasis on special turnkey projects.

CASH TRADER

Designed for non Accountants, you use CASH TRADER like a 140 column Cash Book to maintain complete control over your business, produce VAT Returns, Profit & Loss A/c's and Balance Sheets whilst constantly monitoring Bank Balances, Sales Levels and Overheads. With Analyser you can produce a wide variety of additional 'tailored' reports. Commended for Special Merit by PCW/Evening Standard as ".....an outstanding and original contribution to business profitability and efficiency" Will run on single drive systems.

SHOEBOX

A proven Incomplete Records program in use in many 100's of practices, ShoeBox will pay for itself over and over again. Randomly batched documents are entered rapidly with 20 character descriptions and, optionally, automatic VAT extraction. The optional File Expander increases the standard 400 accounts/2000 entries to 999/32000. Personalised Final Accounts with Notes and Director's Reports can be produced on a number of Word Processing programs which can 'read' data from ShoeBox. Twin drives required.

QUEST BUSINESS CONTROL SYSTEM

With over 35,000 copies sold, the proven QBCS accounting system will suit every business. The Combined Business Pack includes an open-item Sales Ledger, powerful Stock Control and flexible Invoicing routines — using plain or pre-printed stationery. Separate Purchase & Nominal Ledgers are available. With File Expander up to 9,999 Sales & Purchase Ledger A/c's, 32,000 Stock lines and 999 Nominals can be handled. "For a basic.....easy-to-use program which includes accounting, stock control and invoicing the QBCS will take some beating" Micro Decision June 1986.

CASHIER

A complete Legal Accounting system conforming to Law Society rules with an optional Time Recorder at an 'Amstrad' price. Cashier harnesses the power of the computer to speed up posting, eliminate errors and produce meaningful, up to date information and will handle 650 open-item matters (expandable to 5000), 12 Fee Earners, 16 Office/Client Bank A/c's, 60 Designated Deposit A/c's and 80 Nominal Accounts. Requires twin floppy disk drives or a Hard Disk. £499 + VAT.

TIME RECORDER

Suitable for all professional offices, to rapidly and simply record Time and Expenses (at 150 rates) over 200 clients, Time Recorder produces detailed reports on Work in Progress, identifies non-productive time and will prove invaluable in ensuring that Clients are invoiced early, accurately and profitably for all work undertaken. File Expander allows up to 9999 clients. Twin drives required.

COUPON DETAILS

IT Marketing publish a range of Business programs which rapidly pay for themselves in 'time saved' and improved management information. Our programs come with comprehensive manuals which include key-by-key examples. Hotline telephone support is available and periodic newsletters keep users informed of up-dates and new developments.

Our unique Evaluation Packs, which are actually the real program with a restriction on the number of entries, gives you an unrivalled opportunity to study manuals and use the software with your own data at leisure — once you've completed the evaluation, and paid the balance we'll give you a password to remove the restriction.

Designed for Amstrad PC1512, IBM PC and true IBM compatibles, Apricot PC, Amstrad CPC 6128, PCW 8256 and 8512 (Memory disk can be used) and will work with most Epson Compatible Parallel Printers.



IT MARKETING

Cash Trader	99.95	<input type="checkbox"/>
Cash Trader with Analyser	149.95	<input type="checkbox"/>
Evaluation Cash Trader	19.95	<input type="checkbox"/>
QBC Combined Business Pack	99.00	<input type="checkbox"/>
QBC Purchase Ledger	33.00	<input type="checkbox"/>
QBC Nominal Ledger	33.00	<input type="checkbox"/>
QBC File Expander	49.95	<input type="checkbox"/>
Evaluation QBC suite	19.95	<input type="checkbox"/>
ShoeBox	149.95	<input type="checkbox"/>
Time Recorder	69.95	<input type="checkbox"/>
File Expander	49.95	<input type="checkbox"/>
Evaluation ShoeBox/Time Recorder	19.95	<input type="checkbox"/>
Cashier — Evaluation Copy	49.95	<input type="checkbox"/>

Send me more information & review copies
Send me your Dealer Pack
I enclose my cheque
Please charge my Visa/Access/American Express

No _____ Expiry Date _____
Signature _____
Address _____
Computer _____ PC7187

PLEASE SEND ME:

IT MARKETING LTD FREEPOST
BRIXHAM DEVON TQ5 9BR 08045 6566
Orders received before 3pm normally despatched sameday.

FOR THE
EXECUTIVE
ON THE MOVE
TOSHIBA
TOP
PERFORMANCE
AND COMPACT
DESIGN

TOSHIBA
IBM COMPATIBLE
PORTABLE COMPUTERS
AT GULTRONICS



T1100 PLUS

*The portable that thinks
it's a desktop PC!*



T1100 PLUS specification.

- Operating system** • MS-DOS 3.2
- Processor** • 80C86 running at 7.16 MHz or 4.77 MHz
- Memory** • 640K
- Disk drives** • Two 3.5" 720KB offering 1.4MB total storage
- Display** • Supertwist technology
• 80 characters x 25 lines
• 9.1 x 4.7 inches
• 640 x 200 pixels
• Position adjustable a full 90°
- Keyboard** • 81 keys, full size
- Standard interfaces** • RGB colour monitor
• Monochrome composite monitor
• IBM compatible parallel printer/
5.25 disk drive
• RS-232C serial communications
• I/O bus for Expansion Box

- Dimensions** • 12.1" wide, 2.6" high, 12" deep
- Weight** • Less than 10lbs
- Power** • Built in rechargeable NiCad batteries

- Included accessories** • 240VAC adaptor for recharging and mains power operation
• MS-DOS manual
• Owner's manual
• Carrycase with grip handle and shoulder strap

- Options** • Internal V21, V22, V23 Hayes compatible modem (BABT approved)
• External 5.25" floppy disk drive
• Universal Floppy Link to desktop PC disk drive
• Car cigarette lighter power adaptor/charger
• Expansion Box with five IBM compatible slots
• BI-Synchronous Communications Adaptor

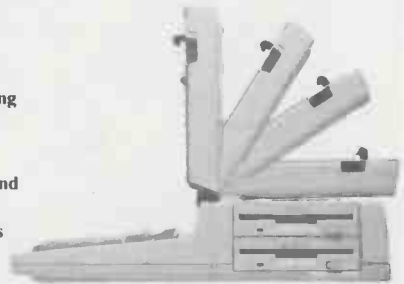

T3100/20MB AVAILABLE NOW

Features

- Enormous processing power – this is the main feature of the T3100.
- The basic version of the T3100 comes with 640 KB of main memory which can be expanded to 2.6 MB.
- The T3100 also has a built-in 3 1/2" drive with 720 KB storage capacity for exchanging data and programs with other computers.

- The hard disk – a standard feature of the T3100 – provides even greater storage capacity than the diskettes.
- The enormous storage capacity, the hard disk offers two other important advantages: considerably faster access to stored data, which means much faster response time for the computer, and greater data security.

GULTRONICS
COMPUTER CENTRE

circle 109 on enquiry card

200/204 TOTTENHAM COURT ROAD, LONDON W1P 9LA TEL: 01-323 2838/323 4612 TELEX: 295358
OPPOSITE GOODGE ST. TUBE STATION

London's main stockists for Amstrad, Atari, Commodore, Epson, Brother, Citizen, Star, Sinclair. Also extensive range of software, Modems and peripherals.

All offers also available at: 43 Church Street, Croydon, Surrey. Tel: 01-681 3344/01-681 0528

CONSULT GULTRONICS BEFORE COMMITTING.

"PLUG IN AND GO!" A NEW BREED OF MULTI-USER COMPUTER

Concurrent
DOS/XM
standard

£

4

4

9

5



The Bromcom QC is a totally new breed of computer, achieving tremendous breakthroughs in price, size and ease of use. A highly versatile four user multi-tasking computer capable of expansion to much larger configurations; the Bromcom QC also acts as a file server to any IBM PC, the new Amstrad PC and most clones.

HALF THE PRICE!

Accustomed to high prices for multi-user systems? The Bromcom QC is under half the price of traditional multi-user systems and is cheaper, per user, than many PC's. But the Bromcom QC doesn't cut corners — 20MB hard disc, full 16 bit processor (running at 10MHz) and 1MB of RAM are standard; 2 or 4 MB RAM memory, 40 or 80 MB hard disk options are now available. Four high specification VDUs, cables and FREE user-menu, diary and electronic mail software complete the package. And all for half the price of a traditional multi-user system.

QUARTER THE SIZE!

Are computers taking over your office? The Bromcom QC is "shoebox" size — making it the smallest and most attractive multi-user computer ever.

PLUG IN AND GO!

Yes it's true! Simply plug in and switch on. User menus ensure even the most inexperienced of computer users get the most from the Bromcom QC.

NETWORKING!



The Bromcom QC is the first system specifically designed to act as a file server to the Amstrad PC and is also an ideal file server for IBM, Olivetti, Ericsson and a host of other PC's.

* subject to available RAM — 2 and 4 MB RAM options are available.

BETTER MULTI-USER COMPUTING

The Bromcom QC allows you to do four things at once! By using Digital Research's Concurrent DOS/XM operating software, any of the four users can run four* programmes *simultaneously*. That's 16 tasks in all. And you can change from doing one task to another instantly, at the touch of a single key. Because Concurrent DOS runs almost all CP/M and MS DOS programmes there's no shortage of software to choose from. You can run Pegasus, Omicron, Wordstar, Supercalc, Sensible Solution, Dataflex, Tas and many, many others.

BETTER EXPANDABILITY

The Bromcom QC has numerous options for add-on expansion:



- Industry standard ARC-Net networking
- 4 extra serial synchronous/asynchronous ports
- 40 or 80 MB Winchester option (instead of 20)
- 20, 40, 80, 150 or 200 MB Winchester add on
- 20 or 45 MB tape backup subsystem
- 2 or 4 MB RAM option (instead of 1 MB)

BETTER FOR YOU

Bromcom QC's are great for any size of business. In small companies a QC can handle all data and word processing activities in one, easy to use, machine. In larger companies and institutions, a QC makes an ideal departmental unit or for communication between departments. Only a few of the software packages available for the Bromcom QC are listed above — there are over 1000 other possible applications.

The Bromcom QC really is the natural progression from the PC. For further details, or for demonstrations, contact us today.

BROMCOM



THE BEST IDEA SINCE THE PC

Bromcom Computers Limited, 417-421 Bromley Road, Downham, Bromley, Kent BR1 4PJ. Telephone: 01-461 3737 Telex: 926012 BCOM G

circle 118 on enquiry card

SECURING THE SUPPLY LINES

Without a regular supply of paper, discs and ribbons your precious computer system will grind to a halt. **Carol Hammond** looks at the best purchasing strategies.

Consumables are important. They are important to users because they are the life blood that keeps a micro productive; without a reliable source of readily available supplies a business could be paralysed. The floppy discs, ribbons, paper and other paraphernalia that feed your micro are important to manufacturers and dealers too; for them, consumables help to maintain loyalty and contact with customers. As hardware prices fall, so consumables become more important as an additional source of revenue, and micro-computer supplies are certainly big business.

Market-research company Frost & Sullivan estimates that in the US small companies spend \$5,000 per annum on micro supplies, and medium-size companies spend \$10,000 to \$50,000. Large companies usually have a contract with a supplier for all their computer supplies.

The *Practical Computing* readers we contacted told us that the main criteria they use to judge consumables are price, reliability and availability. These factors in turn determined where they bought their supplies. We found that people are less likely to shop for supplies with their dealer or a manufacturer. This is largely because dealers and manufacturers do not generally stock a wide range of supplies at competitive prices; if they stock consumables at all they do so more as a service to the customer than as part of a money-making business.

Some users favour mail-order suppliers like Inmac because they offer a good delivery service. You can typically order goods by telephone, fax, telex, post or in person; your order can then be delivered as early as the next morning, or within a few days by parcel post. Inmac offers a computer-rescue service, where it will guarantee to deliver supplies within hours. Such a service obviously bumps up the price. Bulk purchasers may be able to negotiate a price for large quantities,

or take out an annual supplies agreement. A yearly agreement can be to purchase a certain number of supplies or spend a specified sum to receive a discount in return.

Most people we spoke to opted for computer-supplies specialists and office-equipment suppliers for most of their requirements. When it comes to paper, some go direct to the traditional paper merchants, while others got listing paper through another department within their company which used mainframes and was obviously able to get a bulk deal.

Office-equipment suppliers are a popular option, since users can purchase all their supplies from one source. The readers we spoke to tended to go to different suppliers for different products in order to get a good

UK floppy-disc market (£ millions) — SOURCE: MARKET ASSESSMENT PUBLICATIONS

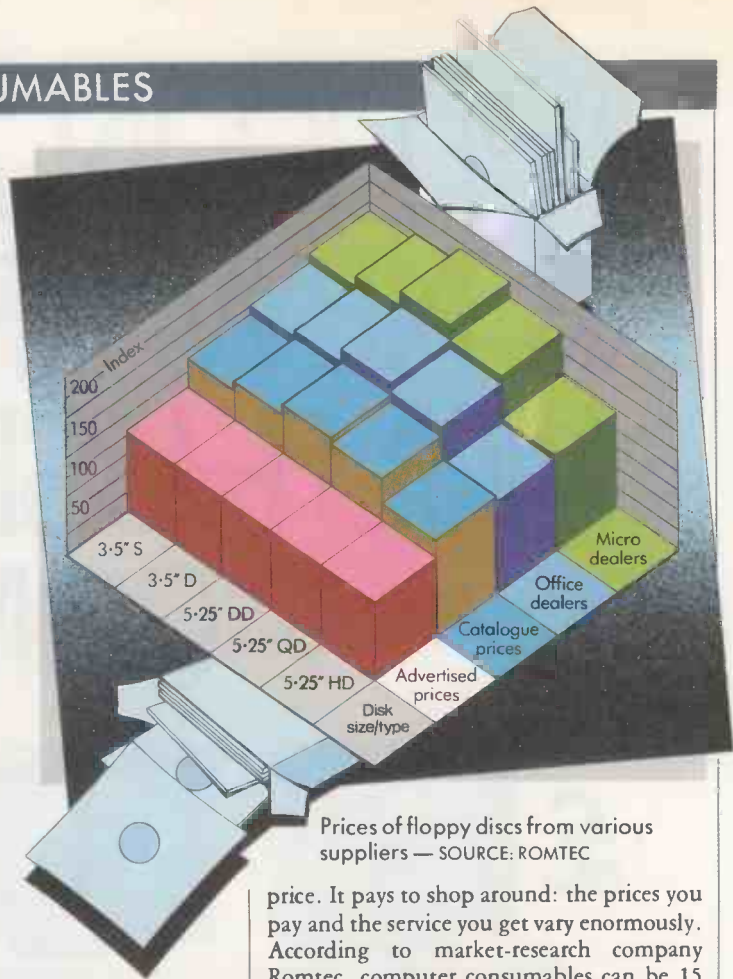
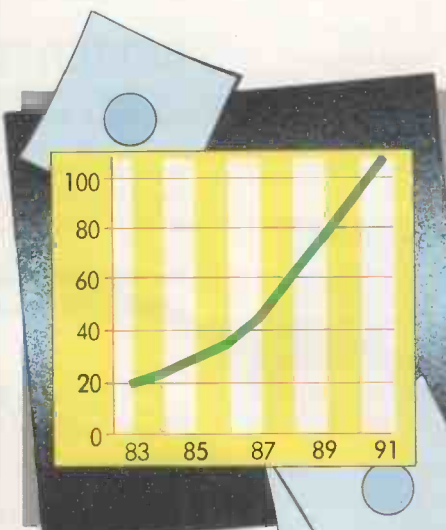

Prices of floppy discs from various suppliers — SOURCE: ROMTEC

price. It pays to shop around: the prices you pay and the service you get vary enormously. According to market-research company Romtec, computer consumables can be 15 percent cheaper from office-equipment dealers than from microcomputer dealers.

Floppy-disc prices in particular tend to vary dramatically. Romtec claims that discounts can be as much as 20 percent on purchases of five or more boxes. The people we spoke to confirmed this: some were able to get floppies discounted by as much as 25 percent and would try to get a further reduction. If you are offered a lower price than that quoted by your usual supplier it is certainly worth going back to see if you can strike a deal. This approach is quite likely to succeed since many suppliers use direct telephone sales to develop their business. You may also find it worthwhile to ring round a selection of suppliers every few months for a quote. The bigger and more regular your order, the more power you wield.

Some suppliers, especially smaller ones, may prefer to have less business and a higher profit margin rather than more business and low profit margins, and so will not cut prices. To make up for hefty price-cutting most suppliers will have to cut services elsewhere — say on delivery times or the variety of products stocked. You may be able to strike a deal which does not involve the supplier slashing prices. One reader we spoke to does not get a discount on floppy discs, but the supplier puts the company's logo on them free of charge, which looks good and reduces the chances of pilfering.

Price is important, but a reliable supplier may be worth sticking to even if you can buy more cheaply elsewhere. You should take into account how convenient it is to order from and pay your supplier too. For example, one reader we spoke to sticks with his existing supplier partly because of an established fax system. Transactions are

CONSUMABLES

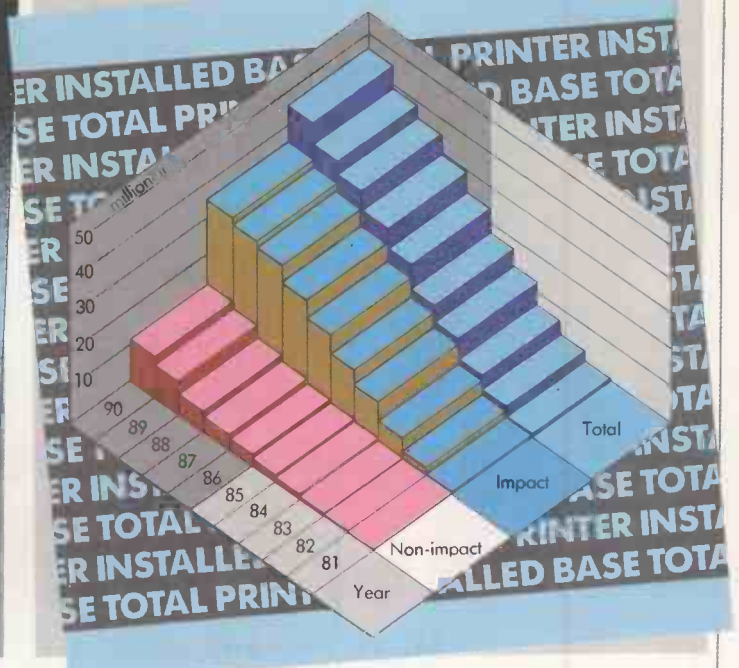
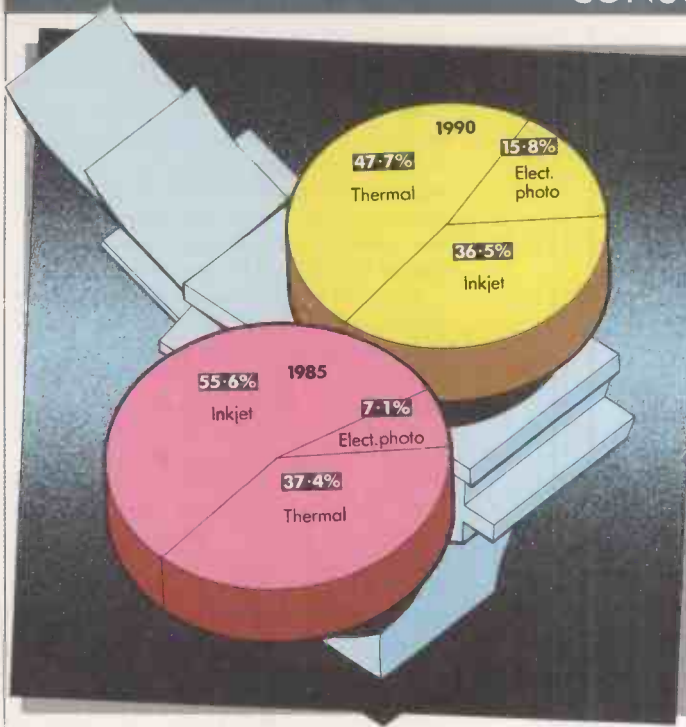

Non-impact printers installed — SOURCE: FROST & SULLIVAN

Total number of printers installed — SOURCE: FROST & SULLIVAN

simple and speedy because invoices and quotations can be signed and faxed across without delay.

A reliable delivery service may be of particular importance for certain commodities. Listing paper takes up a lot of room, and if storage space is limited you may want to keep stocks low and rely instead on frequent deliveries. On the other hand, printer ribbons take up little room and do not have to be frequently replaced, so here you can afford to be more finicky over their price.

Floppy discs are an area in which we found readers tended to opt for quality rather than price. Clearly, the more data you put on to disc, and the more important that data is, the more valuable your disc becomes. With a megabyte of data and more now routinely stored on a single disc, users are primarily concerned that the discs they use are reliable. Discs with reinforced hubs resist wear and tear; discs coated with lubricants are less susceptible to friction from drive heads and pressure pads; discs made from high-grade plastics are able to withstand sudden changes in temperature or humidity without distortion, and are flexible enough not to become brittle and flake.

We found that buyers are able to negotiate a price for floppy discs. At present it is estimated that there is 30 percent worldwide excess of production capacity for floppy discs. Manufacturers have to double their capacity just to maintain their position as price cutting rises up to 50 percent. The floppy-disc glut is partly a result of new companies jumping on to what they saw to be a promising bandwagon. Market research carried out by Frost & Sullivan shows that the number of floppy-disc manufacturers in the US has grown from 20 to 60 since 1980, with another 20 worldwide. The survey shows Verbatim and 3M as leading suppliers, with Dysan dominant in the high-quality business market.

The floppy mountain has also grown because the demand for supplies relates directly to the software and hardware used. As programs have become larger, applications like databases more widespread and multi-tasking more popular, so more people are opting for hard discs for primary data storage, and are merely using floppies for backups.

Moreover, as micros become more standardised the supplies do too, and this leads to increased competition. The readers we spoke to felt there was little to choose between one brand and another — not surprisingly, since many manufacturers provide floppies for OEMs to help keep their output up and hence their own prices down. Even a lifetime guarantee on discs failed to impress the users we spoke to. They were more interested in an honest price, though some took notice of special offers where they got, say, a free storage box for their discs.

This situation is likely to continue, with the popularity of 3.5in. floppy discs increasing. It is estimated that 3.5in. discs will have a 30 percent share of the market by 1988; now that IBM has given its seal of approval to 3.5in. discs for the PS/2 family the proportion might be even higher. It seems that the price-cutting and free-offers war is set to continue until the weaker manufacturers are pushed out and manufacturing capacity is more in line with demand.

The type of software and hardware used affects paper and printer supplies too. Market research done in the US leads Frost & Sullivan to predict that non-impact models, like laser, thermal and ink-jet printers, will quadruple in number to make up 25 percent of the total installed printer base by 1990.

Fabric ribbons are also set to do well, their future assured by the growth of better-quality dot-matrix printing. They are likely to account for almost 90 percent of ribbons sold, while a decline is forecast for the sales

of film ribbons, as used in solid-character printers like daisywheels and line printers. As networking increases, so people are sharing printers. There will be fewer printers per micro, but those that remain are likely to become more standardised and faster. But Frost & Sullivan sees printer-element sales increasing as more people use micros and their attached printers, and as the printers themselves are worked more intensively.

Frost & Sullivan foresees that plain paper will show a strong growth in sales to account for 99 percent of paper sales by 1990, with a tendency towards cut sheets rather than continuous stationery. Although plain-paper printers cost more than thermal printers, plain paper works out cheaper than the treated paper required in thermal printers, so the overall purchase and operating cost is near that of thermal printers. Thermal paper also tends to smudge easily and show fingerprints when handled, and it becomes brittle with age.

When it comes to choosing paper there is little to differentiate one brand from the next; there are only refinements according to people's taste. Some people prefer fanfold paper with a clean tear-off edge for high-quality work, bespoke multi-part forms for special jobs, and so on. The users we spoke to felt that the main consideration when choosing paper was that it did not curl or wrinkle and cause a jam. This depends on the moisture content of the paper, and is therefore as much a result of where the paper is kept as anything else.

One thing emerges clearly: consumables are a buyer's market, and the market-research figures indicate that this will continue. Obviously, as technology advances and sophisticated products like optical discs become the order of the day, prices will increase. But at present, standard items look set to fall in price — and long may it continue.

CHIP WARS

Steve Malone analyses what the US-Japan trade dispute will mean for micro users.

Worldwide concern is being expressed over the imposition of tariffs by the United States against a range of goods coming from Japan. A host of economic Cassandras are predicting the imminent collapse of the global trading system — and there is no doubt that the American moves have serious implications for the world economy.

But what will this do to the industry most directly affected by the measures — the computer business? The components at the centre of the dispute are 256K DRAMs and EPROMs, and these devices are central to the development and manufacture of almost every part of a modern computer system.

The dispute began last autumn, when US trade officials met with their Japanese counterparts to discuss allegations of chip-dumping made by the US semiconductor industry. The Americans charged the Japanese with selling components around the world for less than their manufacturing cost. At the beginning of September the United States and Japan signed a document in which the Japanese government agreed to halt the dumping of semiconductors on the world market.

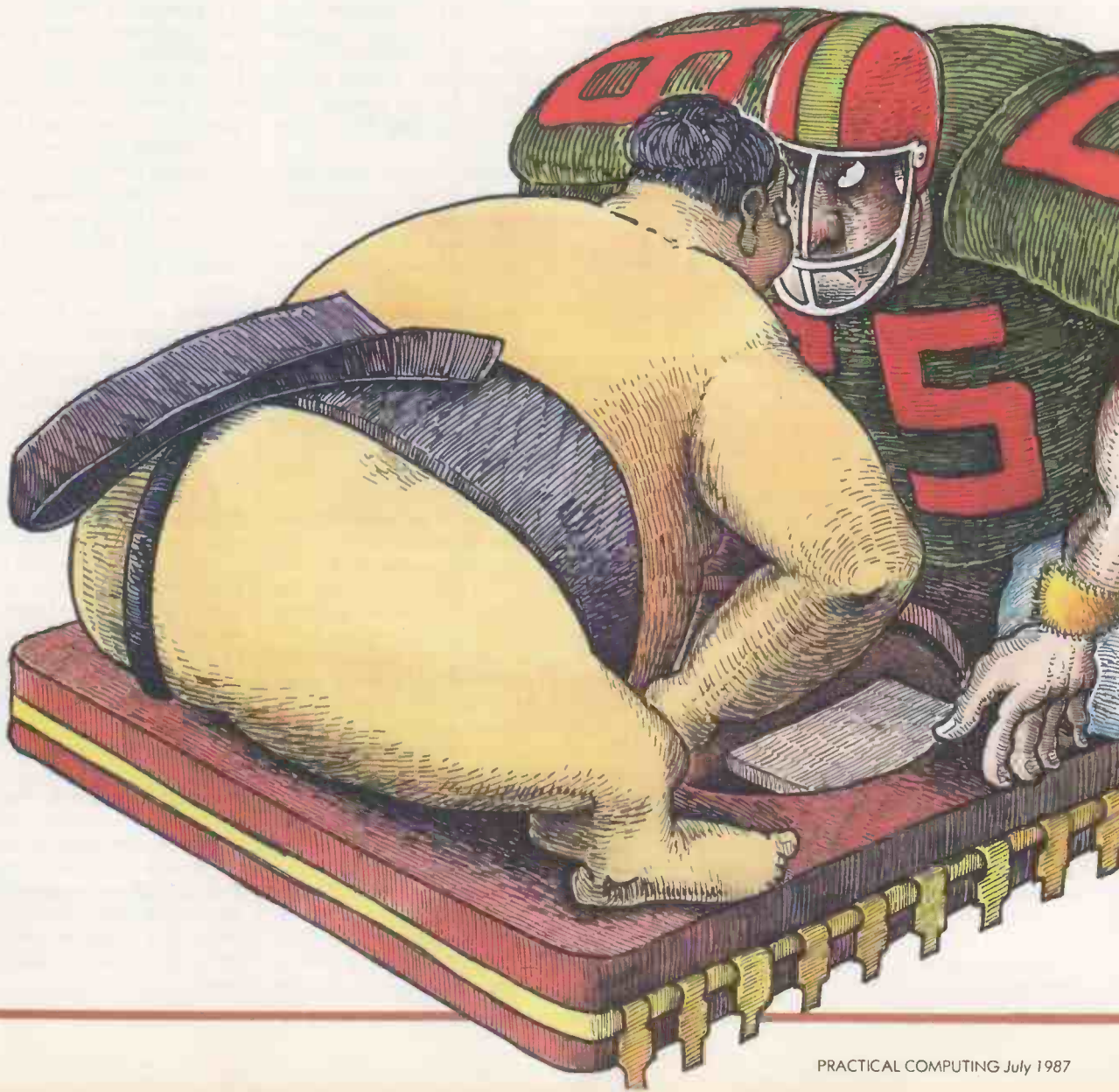

Further talks were held in January of this year, following US complaints that the Japanese were not complying with the agreement. The US Commerce Department had found that DRAMs were being sold on the world market at 59 percent of what it called the fair price, while EPROMs were being dumped at 63 percent of the fair price. The American delegation warned Japanese representatives that there would be retaliation if dumping was not halted within 30 days and if US sales to the Japanese market did not improve within 60 days.

At the end of March the US acted. President Reagan announced a range of tariffs on Japanese goods entering the United States which would effectively double their price. In a statement he said: "Japan has not enforced major provisions of the agreement aimed at preventing dumping of semiconductor chips in third country markets and improving US producers' access to the Japanese market. The most recent evidence we have demonstrates that dumping has continued. Moreover, American firms' access to the Japanese market has not improved from last fall's levels."

Among the Japanese exports earmarked for retaliation were disc drives, communication satellites, calculators, televisions and — strangely enough — x-ray film. Zenith

We believe that in the long term, free-market forces will prevail. In the short term, however, there are going to be certain implications for supply and prices.

was one of the corporations which welcomed the moves. In a statement the company said: "Zenith fully supports the Administration's trade sanctions against Japanese TV and computer makers. Considering the breadth of Japan's unfair trade practices in recent years, these tariffs are actually modest in scope. We hope these sanctions will lead to an overall fair-trade program."

Zenith Electronics is typical of the American companies which have a strong interest in the enforcement of sanctions, even though many of its products — the Z-181 lap portable is one example — are made in Japan. The corporation lost \$10 million last year, due largely to a \$37 million deficit incurred by the TV and VCR division. This is the sector of the American electronics industry that has been the worst hit by the Japanese assault.

As one of the "third countries" referred to in President Reagan's speech, Britain is in an ambiguous position. While there is anxiety among the semiconductor manufacturers about the possible effects of dumping, the computer manufacturers have lately taken advantage of cheap chips. They have now started to worry about the possibility that component costs will rise.

British semiconductor manufacturers do not make 256Kbit DRAMs, so they are not directly affected by the current dispute. But fearing that the present round of dumping could be the prelude to something worse, they have decided to join in a Pan-European effort to prevent a deluge of cheap components.

Richard Bullock of the Electronic Component Industry Federation said: "We think the Americans have got themselves into a frightful tangle in first applying the tariffs and then trying to police them. The European approach is better; it is to apply to the European Commission for anti-dumping duties to be imposed, which are allowed for under the rules of the General Agreement on Tariffs and Trade (GATT)."

"The European Electronics Components Manufacturers' Association (EECA) has applied to the Commission for anti-dumping duties to be imposed. It is to provide evidence of dumping and the effect it has on local producers in France, Germany and Italy. We are supporting EECA by contributing to the costs of its application because if the dumping isn't stopped, we don't know where it will end."

The official position of the EEC is more cautious, although it is equally alarmed at future prospects. EEC spokesman Robert

Elphick commented: "We find it sad that this has happened, but if the Japanese and Americans get together we don't want the hosepipe turned on us."

While the European semiconductor industry prepares to take its case to the European Commission, the US sanctions are already beginning to have an effect. The Japanese government has proposed that all future exports of semiconductors above £32 should be passed to the Ministry for International Trade and Industry (MITI) for a licence. This will obviously produce a dreadful bottleneck in exports of semiconductors to the rest of the world. It will affect even US companies such as Motorola and Texas Instruments which have production facilities in Japan.

The Japanese proposals have already caused a shortage in the supply of DRAM chips and a rise in their price. Apricot is one of the largest manufacturers of microcomputers in Britain, and it is already beginning to feel the pinch. Jes Dorrell, the group's marketing manager, told *Practical Computing*: "We have already seen an increase of 10 percent in 256Kbit DRAMs, although we believe that, in the long term, free-market forces will prevail. The US and Japan do not operate in isolation — we all work in a global industry."

"But in the short term there are going to be certain implications for supply and prices. At the moment we have a plentiful supply of these chips and we hold about three to four months' supply. To put this in perspective, about 10 to 15 percent by value of our range are Japanese components."

Certainly there are signs that large Japanese semiconductor companies are looking at ways in which they might circumvent their government's restrictions. There are reports that some firms are shipping large quantities of wafers — which are not subject to export licences — to their plants around the world. It seems that Japanese manufacturers will simply move their production elsewhere.

Over the next few months there is not likely to be any dramatic increase in price as most manufacturers, like Apricot, have contracts for components to be supplied at a fixed rate. The crunch will come when these contracts have to be renegotiated. Mike Lloyd, Production Manager at Research Machines, told us: "What's causing the most confusion is the situation with MITI. We've had to plan for second sources — including Korean suppliers, who are gearing up their production. The indications are that there are some price increases, but we won't see the impact until we renegotiate."

Prices in the shops will not rise tomorrow, but a long-term upward trend in the price of semiconductor components could have serious implications for some companies. Those which have low profit margins are particularly susceptible to price increases from their suppliers. Until the US and European semiconductor companies recover enough to compete with the Japanese on equal terms, it seems the end-user will pay through higher prices. 



We now know what the operating system for the main top-end business machines will be for the foreseeable future: OS/2. With IBM and virtually every major hardware manufacturer except Apple putting itself behind it, nothing short of extreme consumer apathy can stop it.

However, not everyone is wildly enthusiastic about OS/2, and some scepticism remains as to whether users really will be prepared to migrate across from MS-DOS, which is in any case likely to remain the pre-eminent operating system for low-end users. Many corporate users may end up going no farther than Microsoft Windows, which is a kind of halfway house.

OS/2 is unlikely to be available to end-users before the spring of 1988. The first release of the toolkit for OS/2 software developers should be available this year, in August or September, with upgrades coming through steadily thereafter as more of OS/2 is completed. This schedule means that major new software applications which make use of OS/2's more advanced features are very unlikely to come through until about two years from now.

Microsoft Windows, on the other hand, is available now. Visually, it has a similar user interface to OS/2. It also shares one of the key benefits of OS/2 — device independence — as well as a more limited kind of multi-tasking. A new version, Windows 2, which will have an identical visual interface to OS/2, is scheduled for release in the third quarter of this year. Windows 2 will also offer proper memory management for the current generation of third-party extended memory boards, as well as support for the new IBM Personal System/2 machines.

DIFFERENCE OF SCALE

The key features of OS/2 are shown in the box overleaf. Several of these benefits are already available with Microsoft Windows, and Microsoft seems likely to add more OS/2 features to Windows as it develops them. The really key difference between the two operating systems is one of scale: OS/2 promises support for more memory, more powerful data links between packages, and much more sophisticated multi-tasking.

Despite all its wonderful features there are still some problems with OS/2. Some of them are matters of opinion, but others are based on hard fact. Many of the most negative opinions were expressed to us off the record. In public, everybody in the software industry is saying they are supporting OS/2, so as to reassure customers that they are on the ball and modern, and capable of following the growth path that IBM has laid down.

But in practice this support may not amount to much. Any MS-DOS application will run under OS/2 in its compatibility box at the bottom of memory; this does not give the user access to any of OS/2's new features, but the software company can truthfully say it is supporting OS/2. Other houses are actively adapting their software for Microsoft Windows, but this still leaves

HOW BRIGHT IS THE FUTURE?

OS/2 heralds the biggest change ever for business-micro users. **Ian Stobie** looks ahead to the brave new world of software and wonders whether it will be to everyone's advantage.

them the option of stopping short of OS/2. The prevailing attitude seems to be one of wait and see.

At least on the early release of OS/2, memory management is still a bit of a botch. OS/2 does not provide a straightforward and clean linear address space. For the time being, data and programs still have to be divided into 64K segments, even on 80386-based machines.

This is primarily a problem for software developers, who will have to write their way around the problem. OS/2 could have helped them more, and in two or three years some future full 80386 version of OS/2 will probably solve the problem. But the Mac can do it now; OS/2 is not the state-of-the-art operating system it is made out to be.

Multi-tasking may turn out to be more of a benefit for the vendor than the customer. It does little for the typical PC user, and few applications will make much use of it. But it is pretty well essential for good communications through to mainframes. The stress on multi-tasking in OS/2 looks very like part of an IBM strategy to woo the traditional DP manager. IBM's goal would be to say to the DP manager: "Look, you can have control again."

But even this is probably a bit of a con. Applications which would sensibly allow the central computer department to validate, audit and consolidate data from a mass of PC spreadsheet users are probably several years away. Even then they are likely to be prohibitively expensive for the extra benefit they bring. It is all a bit of a dream, though it is a dream of control which may appeal to some users.

Where OS/2 is really taking a hammering from several quarters is over its timing. For practical purposes the release schedule puts OS/2 at least a year away. Even then, the initial versions of OS/2 will be rather cut-down affairs. IBM will be releasing first a

version without Presentation Manager, the Windows-like user interface, and OS/2's memory management will be less than perfect for several years to come.

The real question is why it took IBM and Microsoft so long to produce OS/2. The two companies have a joint development agreement over the product, under which both contribute to the design and development effort and both possess marketing rights to the final result. The suspicion is that this arrangement held Microsoft back. As John Page of Software Publishing points out, the really crucial thing that both developers and users wanted was a solution to the memory problems of MS-DOS. Multi-tasking was on hardly anyone's priority list, except IBM's.

But much of the effort in developing OS/2 must have gone into multi-tasking, which is a complicated thing to implement properly. The end result is that OS/2 will arrive with a sub-optimal memory-management system, too late to help many users with their current problems. According to Page, "They've done a 1984 memory-management system in a 1987 OS." We could have been given decent memory management sooner.

This is not to say that IBM or Microsoft have been remiss or incompetent — quite the opposite, especially in IBM's case. IBM's real problem is how to beat rival PC manufacturers, and OS/2 stands to help achieve that goal. The company's strength has always lain in its strong relationship with central DP departments. OS/2 provides a clear way of cementing this alliance in the PC area. Machines like the Macintosh will look less desirable to companies with a highly centralised purchasing structure, as now they fit less well into an IBM-influenced grand plan.

All IBM's talk about Systems Application Architecture (SAA) fits into this rather Machiavellian view of the purpose behind OS/2. SAA is a group of standards covering things like the user and program interfaces and communications protocols for IBM's three main strategic product lines: the PS/2 micros, System 3X minis and System 370 architecture mainframes. OS/2 is a key part of SAA, and the first to be fully defined.

STANDARDS

OS/2 and the Micro Channel Architecture of the new PS/2 machines should be taken together in this context. If users really do embrace these standards, then IBM will have succeeded in hooking them on an architecture which requires IBM kit when they get to the mini level. The heavy re-vamping of the System 3X range to fit it into SAA that is going on at the moment certainly makes this plausible.

OS/2's graphic interface will probably do users good. After all, training is becoming a major burden as more and more people — many of them inevitably less enthusiastic than the early pioneers — are given computers to use. MS-DOS really was quite unsuitable for such people. Under OS/2, applications from different manufacturers

(continued on next page)

KEY FEATURES OF OS/2

MEMORY LIMIT LIFTED The 640K memory limit which has irked MS-DOS users for so long disappears. In the initial releases of OS/2 you will be able to use up to 16byte of RAM: this is the amount that can be directly addressed by the 80286 chip. In later releases, this will go up to 1Gbyte for people who have got 80386-based hardware.

VIRTUAL-MEMORY MANAGEMENT From the outset, OS/2 users will be able to assume they have much more RAM fitted to their system than they really do. This is because OS/2 has a virtual-memory management capability. Provided you have enough hard-disc space you can carry on as if you have up to 1Gbyte of RAM installed on your system. OS/2 will swap chunks of program or data to or from disc automatically to achieve this. Buying lots of real RAM will only be necessary if you want more speed.

MULTI-TASKING OS/2 is a truly multi-tasking operating system, something that MS-DOS is not. This means that all the kludges that were essential to make pop-ups, comms and networking software work properly under MS-DOS are no longer necessary. It also means you can have several major applications loaded up in memory at the same time, and instantly switch between them. OS/2 will make it possible to run certain kinds of task unattended in the background while you do something else on-screen. Suitable tasks are compiling, sorting, or sending or receiving a file across a comms link.

FILE LIMIT OFF The old limit of 20 files open at a time is raised to 255. While this does not affect the typical user, it should make it a good deal easier to port mini and mainframe applications down on to PCs.

GRAPHIC INTERFACE The MS-DOS prompt and command line disappear. OS/2's user interface, called the Presentation Manager, is closely based on Microsoft Windows. You control the

system by selecting items from pull-down menus or pointing to symbols on the screen, using either the keyboard or a mouse pointing device. OS/2 applications run in resizeable windows on the screen, which you can overlap or copy data between. This is all familiar stuff to Macintosh users, but with OS/2 it should finally come in from the margins to the centre of corporate computing.

CACHEING STANDARD The Buffers command of MS-DOS provided only a very limited cacheing mechanism. OS/2 automatically makes use of available memory to boost disc performance by cacheing disc accesses in a much more powerful way. This should speed things up considerably.

DYNAMIC DATA LINKS In addition to providing the user with a clipboard for moving data between different applications manually, OS/2's combination of virtual memory, multi-tasking and a set of agreed data formats will allow software developers to implement powerful automatic data links between packages. Several applications can be resident and running in memory at the same time, and they can all access the same data if required. For example, you could hold reference data in a spreadsheet formula which in fact resides in a database. The software could then do the database extraction for you without requiring any further intervention. Integration of separate programs such as spreadsheet, database, graphics and word processor should be easier to achieve.

DEVICE INDEPENDENCE Getting peripheral hardware such as screens or printers to work should be a good deal simpler than under MS-DOS. OS/2 isolates application programs from the details of the hardware. The software necessary to support a lump of hardware is written as a free-standing driver to OS/2 conventions; when you install the device it is incorporated into OS/2. This is a once-and-for-all process, so you do not have to indulge in detailed tinkering in each application.

(continued from previous page)

should all look more similar and work in a more similar way, so they should consequently be easier to learn.

Of course, some users do not like the mouse, but OS/2 cannot be faulted here. Microsoft has taken great pains to redesign the original Windows interface so it will work well without a mouse. All the menu options, for instance, have a unique letter somewhere in the word underlined. For example, Minimise would probably be distinguished from Maximise by underlining the I and the X respectively. If you are using a keyboard you can then type I or X in this example to choose between them instead of pointing with the mouse.

ADAPTING TO OS/2

Among those least enthusiastic about the user interface are some software developers, especially companies that have made a big selling point of their own user interface. With OS/2 this means of differentiating products appears to become less effective. It also means that the companies will probably have to support two versions of most products — one for OS/2- or Windows-equipped PC users, and another for the large number of existing users who have neither. However, since the Windows side of OS/2 is likely to prove popular with users, it is hard to see anyone resisting for long. And on the Macintosh, where all programs have

always looked pretty similar, it is still not hard for users to sort out the programs which use the interface conventions well from those that do it badly.

One big surprise of OS/2 is that it still has the 32Mbyte disc volume size limit of MS-DOS. This means that if you have a large hard disc you will still need to divide it up into several independent nominal drives. Within the context of IBM's enthusiasm for mainframe links and optical discs, it is potentially a greater inconvenience, since you will not be able to map very large data sets straight to a disc.

The 32K limit persists because all the file-allocation table (FAT) arithmetic in OS/2 is still 16-bit. Within a 16-bit number, 64K is the largest quantity you can represent; the typical hard disc has sectors of 512K, so you end up with a 32Mbyte limit. The FAT arithmetic has presumably been ported straight across from MS-DOS. This kind of code is heavily optimised for speed and therefore impenetrable; a rewrite would not be a fun task. Both Microsoft and IBM say the limit is likely to come off in some future release of OS/2, though nobody is mentioning any dates. But until something is done about it OS/2 really cannot claim to be a 32-bit operating system.

But as far as users are concerned the main problem with OS/2 is that it is not here yet, and it is impossible to assess it properly until it is. Meanwhile the Windows bandwagon is

starting to roll, with many software houses now rewriting their packages to support Microsoft's Windows. They will then be in a good position to move to OS/2 if necessary, but they can still service much of their existing MS-DOS market.

For all the reservations that one might have about OS/2 it will have a radical effect on the next generation of applications software. Spreadsheet performance will be improved by the ability to multi-task. Busting the 640K limit will probably benefit only power spreadsheet users in the short term, as few users are really pushing up against the limits of worksheet size with current products. But more intelligent user interfaces need the extra memory; at the moment Lotus's Hal for 1-2-3 requires something like an Above Board, and this is the type of product that is likely to take off with the new O/S. Multi-tasking will allow spreadsheets to recalculate at the same time as interacting with the user.

All the major spreadsheet companies are working on OS/2 versions of their products. Lotus appears to be heavily committed to OS/2, and will be developing a product code-named 1-2-3/G, which will exploit the visual user interface to the full. Lotus also believes in the idea of a link between local spreadsheets running on micros and the corporate mainframe. It will be developing both a mainframe version of 1-2-3 and database products to support this link.

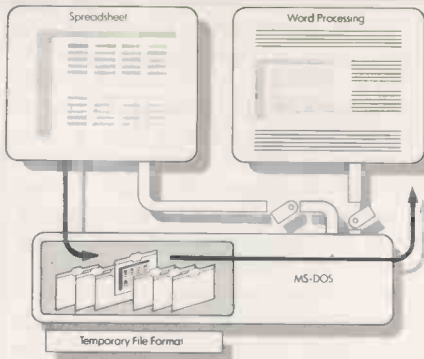

Above: MS-DOS applications run independently of each other. To move data between them you generally have to create a temporary file, then exit one application and start another.

Below: With OS/2 you can have several applications all actively working on the same data. There is no need to exit an application to transfer data.

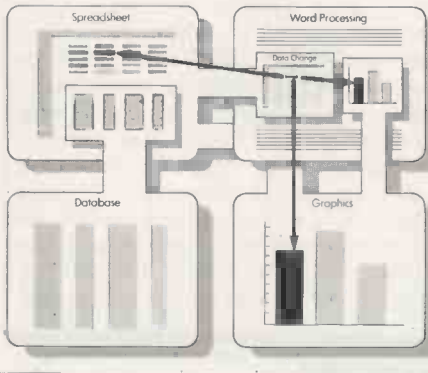

Microsoft itself will shortly be announcing Excel, which is expected to be available under Windows this year and under OS/2 as soon as the full version of the operating system becomes available. Judging by the performance of Excel on the Macintosh, it should be a very impressive program. Excel is probably the only spreadsheet with both the marketing clout and the necessary performance to have a hope of dislodging Lotus 1-2-3 from its leading position.

DESK-TOP PUBLISHING

Desk-top publishing (DTP) is custom-made for the new operating system. It is both memory hungry and disc intensive, so it will benefit from the extra address space and quicker disc access. But the key advantage for software companies writing DTP applications is device independence. OS/2 can be left to take care of screen and printer support, so DTP developers will not continually have to rewrite their code to take advantage of the latest output hardware. However, you have the advantage with Windows as much as with OS/2.

Of course, many existing desk-top publishing packages do not use Windows, so the initial development effort to write for OS/2 will be substantial. Significantly, Xerox is having Ventura Publisher rewritten to run under Windows and OS/2; at present it is a Gem-based application. Aldus PC Page-maker, the other main candidate for leader-

WINNERS AND LOSERS

MICROSOFT Whatever happens, Microsoft cannot lose. If OS/2 is a flop — in other words, if only the biggest and most true-blue of corporates adopt it — Microsoft will still do well out of Windows. All the publicity surrounding OS/2 will have the effect of making people take Windows seriously, as it has the same interface; they may then stick with it. It seems probable that Microsoft will reverse-engineer features taken from OS/2 into future releases of Windows. It is important to remember that Microsoft has not aligned itself with IBM to the extent of submerging its own interests. The two companies will still be competing with different versions of Unix, and will offer different network software solutions.

LOTUS Lotus also has a joint development agreement with IBM, but the outcome looks less sure than in Microsoft's case. Lotus is particularly impressed by the multi-tasking and data-interchange aspects of OS/2. All its major products — including the Freelance graphics package, the Manuscript word processor and 1-2-3 — will integrate together in a modular way. This may well prove popular with users. Lotus is the key company in IBM's mainframe-to-micro link strategy. Lotus is developing the mainframe version of 1-2-3, which will be the application; it will sell the idea to the corporates if anything will. Lotus and IBM are also working on SQL-based database software. The significance of SQL is that it provides the interchange format which will allow micro users controllable access to mainframe data. This is all very ambitious stuff, and it is impossible to say yet how users will respond to it. If all this effort leads to Lotus diverting effort from its bread-and-butter market of the stand-alone micro spreadsheet, where it is under increasing pressure from both clone and original products, it will turn out to be a mistake. But the chances are that the link with IBM will enhance Lotus's prestige enough to keep its pricey products selling successfully against the clones, and Lotus will probably remain a winner.

DIGITAL RESEARCH With IBM now firmly attached to Microsoft, other system software companies are likely to be most seriously affected. Despite confidently writing off OS/2 as "vapourware" in the immediate aftermath of the launch, Digital Research is likely to be damaged by it. DR's low-end Gem operating system, currently bundled with the Amstrad PC, can continue unaffected, but OS/2 is likely to cripple prospects for DR's flagship operating system, Concurrent DOS, at least on stand-alone systems. Digital Research has just launched a new £295 desk-top publishing package, Gem Desktop Publisher, along with a word processor it has bought in from another software house. This may herald a major change of direction for the company towards applications software.

NOVELL Novell could also be in some difficulty. In numerous versions, its Netware product currently dominates the network operating-system market. Its problem is not so much that IBM and Microsoft have both unveiled their own new LAN solutions; Novell has been able to live with things of that kind in the past. The real difficulty is that Novell's network software emulates MS-DOS, rather than hooking into it. To rewrite it to work properly with OS/2 will be a very considerable job. Novell has certainly lost out with OS/2.

APPLE On the face of it, OS/2 looks like dreadful news for Apple: with OS/2 IBM has stolen its clothes. However, Apple's chance lies in the big delay before real OS/2 applications arrive. IBM and Microsoft have validated all the concepts of the Macintosh user interface that has hitherto been so mistrusted by the big corporates. If Apple is any good at selling itself, it could end up a surprise winner.

ship in this sector, is already available as a Windows product, so it is sitting pretty. The biggest dilemma will be for companies like Software Publishing Corporation, whose Harvard Professional Publisher does all its screen and printer handling itself. Desk-top publishing programs are large and complex, and a complete rewrite is a very big job.

In the short term, word processing is unlikely to be affected significantly by OS/2. Many of the simpler products may continue to satisfy users, running without change in the compatibility box. Scientific and foreign-language word processors are likely to be rewritten before long to take advantage of improved screen and printer support, as are top-end products with desk-top publishing features like multiple on-

screen founts. OS/2 will offer these facilities, but again Windows will do.

In the longer term, the full multi-tasking of OS/2 may prove very useful for word processing. The word-processed report is often the natural end product of work done in many other sorts of packages, so good data links are essential. Multi-tasking capabilities can help provide better database facilities for mail merging, or providing more effective links to separate database packages. Spell checking is also well-suited for execution as a concurrent task.

Like desk-top publishing, the heavy-weight CAD and presentation-graphics applications are likely to be rewritten to make use of the features of OS/2. Graphics

(continued on next page)

(continued from previous page)

applications push screens and printers to their limits, so device independence is likely to be the main benefit. Full OS/2 versions of Autocad and presentation products like Harvard Presentation Graphics and PC Paintbrush are already under development. For CAD the multi-tasking and mainframe-link aspects of OS/2 may well be useful, but Windows-level sophistication should do for presentation products.

Pop-up programs will have to be completely rewritten if they are to run outside the compatibility box, or even at the same time as applications running outside the compatibility box. Borland has already announced that Sidekick will be available as a full OS/2 application, and other publishers are likely to follow suit.

OS/2 is not all bad news for pop-up developers. With the operating system in control, they will no longer have to worry about making the programs compatible with other pop-ups. The user can forget about things like order of loading. OS/2 provides full access to the keyboard state — not just the ASCII value of the key pressed, but its physical position, whether it was Shifted and even the exact time of depression. This means the hot-key principle can still be used. Saving and restoring the screen state should be a lot easier to code. If anything, OS/2 should increase the number of programs that use the pop-up principle, as it brings order to a previously very chaotic part of the PC world.

The protection offered by OS/2 is a big step forward for communications programs and LAN software. All such programs are likely before long to be rewritten to run as full OS/2 applications. OS/2's full priority-scheduled multi-tasking is a feature of great power and sophistication that will be highly useful to software developers. Things like print spooling and monitoring an electronic mailbox become very much more attractive. Much of the work can be done on a low priority in idle microseconds, without detracting from the performance of your main task.

COMMUNICATIONS

Some comms applications are very time-critical. For example, you want your system to respond fast to signals during a high-speed file transfer. Here OS/2's ability to assign different priorities to different tasks is very helpful, allowing active comms programs to be given the highest priority.

Databases can benefit from OS/2 in much the same way as spreadsheets. Performance can be enhanced by rewriting database software to make use of multi-tasking; background sorting is an obvious way to save time. More friendly but memory-hungry user interfaces are likely to follow in due course. Microrim with Rbase and Borland with Reflex are going for full OS/2 compatibility.

Where database developers can really get working now is on advanced multi-user databases. Lack of clarification of IBM's

LAN strategy has held back work in this area. From the specifications of the new LAN, comms and operating system products it looks quite possible for the work of running a database to be distributed across a net, and for different operating systems to work in a co-operative way. A suite of database software could, for instance, allow users to get data transparently from one or more file servers, with Unix actually managing access to the data. Meanwhile a matching program on each work station could provide a friendly front end using OS/2's Presentation Manager. The key here is, again, OS/2's ability to multi-task. A separate OS/2 task would be running below the user's level of awareness to manage the link into the Unix network.

Integrated software, which enjoyed a brief period in vogue three or four years ago, may be set to make a comeback. The main reason people did not like integrated packages in the past was that they were so very slow. But with extra memory and better use of discs, as well as more powerful machines, speed should be less of a problem. This time round, integration is likely to take modular form, with separate packages for each major user task communicating dynamically among themselves. People may prefer to continue buying less all-embracing applications, simply because they are easier to learn, but OS/2's improved facilities for data transfer and the more standard user interface it imposes should make ad hoc integration by the user much simpler. 

INTRODUCING THE NEW

GPR-2000

DAISYWHEEL PRINTER

AMAZING
VALUE!



The ideal letter quality printer
for reports and general
correspondence.

Manufactured in Japan.

Complements all modern PC's

- ★ 18cps printing speed
- ★ Variable line spacing
- ★ 10, 12 & 15 pitch
- ★ 96 char daisywheel
- ★ Interface - parallel standard
- ★ RS232 option
- ★ Qume compatible
- ★ Paper-max 13" wide
- ★ Front panel controls
- ★ Low noise 58dBA
- ★ Bi-directional logic seeking print system
- ★ Supports Wordstar commands
- ★ Tractors & S/Feeder option

THE
VERY
LATEST DESIGN
WITH UP TO
THE MINUTE
STYLING

Internationally available ribbons and
daisywheels guarantee low running costs.



The GPR-2000
accepts Qume
fabric or film
ribbon cassettes



Wide choice of
Qume compatible daisywheels

DATAPLUS

DATAPLUS (Sales) Ltd.
PO Box 122, CHELTENHAM, GL51 8QL

TELEPHONE **0242 573573** 24
ORDERS **0242 573573** HR

DATAPLUS (Sales) Ltd.
PO Box 122, CHELTENHAM, GL51 8QL

Please supply _____ GPR 2000
Daisywheel printers at £228.85 each incl. VAT.
plus £8.50 courier delivery and insurance.

cheque Access Visa

Expiry date _____

Name _____

Address _____

Post Code _____

Daytime Tel No. _____

Reg in England 2080289

LOOK!

1/2
THE
PRICE
OF
SIMILAR
MODELS

ONLY
£199

+VAT + P&P

Plus
FREE

- ★ 10 & 12 pitch daisywheels
- ★ Spare ribbon cassette
- ★ Dust cover
- ★ Detailed user manual & mains lead
- ★ Interface cable to your computer
- ★ £10 voucher for VOLKSWRITER
de Luxe word processor

NO QUIBBLE - FULL MONEY
REFUND IF NOT DELIGHTED

STACKING FRAMES

Overcrowded computer room?
- Reclaim valuable floor space
with a purpose built stacking
frame.

* Designs available for the
most popular controllers.

IBM 3174 local and
remote
IBM 3274 local and
remote
Memorex local and
remote
Harris Systems

* Cable management

* Cable protection
end panels

* Colour: IBM beige

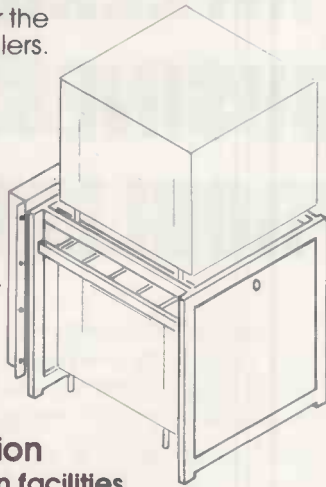

Prices on application
Design and production facilities
for customised products.

MDS

MDS Industries (UK) Limited
Factory 1 Ebbens Road
Hemel Hempstead Herts HP3 9QS
Tel: (0442) 217875

→ circle 145 on enquiry card ←

The 'Classic' Menu Generator.

Eliminate all user contact
with operating system
commands. Use **MENUGEN**
from Microft Technology to
create menus to access all
your regularly used programs.

MENUGEN is a utility
which will create menus for
any activity. A menu selection
will run a program, call another menu, return to a
previous menu, run a basic program, execute operating
system commands, or exit to the operating system.

User Ltd. Selection Menu

- 1 ASPECT
- 2 Wordstar
- 3 Lotus 123
- 4 Disk formatting menu
- 5 Exit to operating system

Please type in selection number

FACILITIES INCLUDE

- UP TO 20 MENU OPTIONS PER MENU SCREEN
- UP TO 15 LEVELS OF NESTED MENU
- ANY NUMBER OF LINES OF HEADINGS AND FOOTNOTES
- USE OF COLOUR - FULLY USER DEFINABLE
- 'ARE YOU SURE?' MESSAGE OPTION AFTER ANY SELECTION
- PROMPTING FOR UP TO 16 PARAMETERS AFTER ANY SELECTION
- OPTIONAL PASSWORD PROTECTION ON MENU SELECTIONS
- OPTIONAL LOGGING OF ALL SELECTIONS TAKEN

MENUGEN is available for most CP/M, MS-DOS
or PC-DOS micros including IBM PC/XT/AT and
compatibles, Sirius, Apricot, HP150, DEC Rainbow,
and many Z80 machines. **MENUGEN** costs £48 + VAT
(£55.20) for a single user licence, or £120 + VAT (£138)
for a network licence, and is available from Microft
Technology Limited, The Old Powerhouse, Kew Gardens
Station, Kew, Surrey TW9 3PS. To order, or for further
information, telephone 01-948 8255.

MENUGEN

MENUGEN is a Trade Mark of Microft Technology Ltd and is a British product.

→ circle 146 on enquiry card ←

FREE OVERNIGHT DELIVERY*

01-455 9823

COMPUTERS/CALCULATORS/PLOTTERS

LASER PRINTERS			
CANON L8PB.....	£1835.00	HP 18C (BUSINESS CAL).....	£160.00
EPSON GQ3500.....	£1395.00	HP 28C (SCI PRO CAL).....	£200.00
QUME LASER TEN.....	£2285.00	HP7440 (A4 2 PEN PLOTTER).....	£860.00
NECL80B.....	£2399.00	HP7475A (A3 6 PEN PLOTTER).....	£1499.00
HP LASER PLUS.....	POA	HP7550A (B PEN A4/A3).....	£2850.00
HP LASER JET.....	£1750.00	HP7580B (A1).....	£7500.00
HP THINK JET.....	£435.00	ROLAND 980 (A3/8 PEN).....	£1075.00
RICOH LP 4081-RI (WITH HP LASER		TAXAN 710 (A3/6 PEN).....	£895.00
+ EMULATION).....	£2999.00	SHARP PC 1500A.....	£157.00
AST TURBO-LASER.....	£3550.00	PC1600 (16K).....	£230.00
OKI LASERLINE.....	£1750.00	EPSON PC AX WITH 20MB H/D.....	£1950.00
OLIVETTI M24.....	POA	AMSTRAD 8512 PC/1512	
EPSON PC 256K + 2 x 360K/D.....	£650.00	(MONO/COLOUR/DISK 10/20	
EPSON PC 256K + 360K/D+.....	£999.00	M8/H/D.....	FROM £449.00
20MB H/D.....	£999.00	AMSTRAD SOFTWARE SAGE	
360K/D.....	POA	BUDGET DELTA 4/ABC BUSINESS SYSTEM	
HP41 CV COMPUTER.....	£139.00	STOCKED	
HP41 CX COMPUTER.....	£199.00		

MONITORS/PRINTERS

MICROLINE 182 (120CPS).....	£193.50	TAXAN - PRINTERS AND PLOTTER RANGE	
MICROLINE 192 (180CPS).....	£307.50	EPSON COMPLETE RANGE IN STOCK	
MICROLINE 84 T/F (200CPS/NLQ).....	£620.00	LX86 (120CPS).....	£210.00
OKI 294 (400CPS).....	£770.00	LO1000 87K BUFFER (180CPS).....	£643.00
OKI COMPLETE RANGE IN STOCK		LOB00 (60 180CPS).....	£470.00
NEC P7.....	£465.00	LQ2500.....	£787.00
NEC P5.....	£750.00	EX800.....	£439.00
NEC COMPLETE RANGE IN STOCK		EX1000.....	£559.00
DISK DRIVES/TAPE STREAMERS POA		SQ2500 (NEW).....	POA
DISC DRIVES TAPE STREAMERS.....	POA	BROTHER HR20.....	£333.00
QUME 12/20.....	£410.00	HR25 (3K BUFFER 25CPS).....	£549.00
QUME 12/45 SPRINT (S/P).....	£599.00	HR35 (35CPS).....	£720.00
QUME 1190 (90 CPS).....	£1355.00	2024L (190C/NLQ).....	£690.00
QUME COMPLETE RANGE IN STOCK		1709 (240CPS).....	£456.00
STAR NB15 (136COL/300CPS).....	£760.00	HR40 inc SSF T.....	£770.00
MODEMS			
IDACOM/MASTER/EPSON/			
NIGHTINGALE/INTERLEKT/			
STEEBEK/ANSWERCALL ETC			
FROM.....	£73.50		
MANNESMANN TALLY (FULL RANGE)			
MT295 (IBM/EPSON COMP).....	£600.00		
MT190 (INKJET 220/110CPS).....	£395.00		
MT85 (80 COL IBM).....	£264.00		

BUFFERS/IN-LINE 1256K/512MG
AUTO-SWITCHES/BI-DIRECTIONAL
CONVERTERS

MONITOR/TERMINALS

ZENITH.....	FROM £425.00
TELEVIDEO.....	FROM £280.00
WYSE.....	FROM £360.00
QUME.....	FROM £360.00
HAZELTINE/SPRIT.....	FROM £425.00
TAXAN/PHILIPS/ZENITH.....	FROM £65.00
NEC MULTISYNC COLOUR IN STOCK	

CAN YOU FIND A LOWER PRICE
PHONE US LAST FOR BEST DEAL

SOFTWARE

IBM/COMPAG/OLIVETTI/AMSTRAD		SMART WORD PROC.....	£220.00
LOTUS 1-2-3.....	£222.00	DATA MANAGER.....	£299.00
SYMPHONY.....	£330.00	MICROSOFT PROJECT.....	£278.00
D/BASE II.....	£223.00	SUPERCALC 4.....	£238.00
GRAPHWRITER COMBO PAK.....	£339.00	TURBO CAD.....	£330.00
CHARTMASTER.....	£295.00	WORDSTAR 2000.....	£215.00
MAP MASTER.....	£295.00	WORDSTAR PROF 4.0.....	£267.00
PFS PROF WRITE.....	£189.00	MULTIMATE.....	£267.00
PFS PROF FILE.....	£229.00	QUICK COOE III.....	£179.00
PFS PROF PLAN.....	£250.00	SAGE CHIT-CHAT.....	FROM £78.00
FREELASE +.....	£350.00	SAGE ACCOUNTS.....	FROM £85.00
FRAMEWORK II.....	£335.00	CROSSTALK.....	£120.00
D/BASE III PLUS.....	£335.00	GEM PAINT/WRITE.....	£125.00
D/BASE CLIPPER.....	£399.00	BORLAND TURBO RANGE.....	FROM £22.00
JAVELIN.....	POA	JENNIFER.....	£275.00
R BASE 5000.....	£220.00	SAMNA PLUS.....	£498.00
EASY FILLER.....	£199.00	MULTIMATE ADVANTAGE.....	£295.00
TRAINING LOTUS 1-2-3.....	£65.00	DRMIS 3D/BASE.....	£295.00
LOGISTIX.....	£90.00	LATTICE C COMPILER.....	£245.00
HERCULES GRAPHIC CARD PLUS.....	£195.00	DELTA PROFESSIONAL.....	£333
FORMATTING AVAILABLE		REFLEX-WORKSHOP.....	£63
HARVARD PRESENTATION		SAGE RETRIEVE.....	£71
GRAPHICS.....	£250.00	VP INFO.....	£69
MS WINDOWS.....	£78.00	LOTUS MANUSCRIPT.....	£269
COBOL COMPILER.....	£495.00	VENTURA-DESKTOP PUBL.....	£269
PASCAL COMPILER.....	£190.00	WORDSTAR 2000 +.....	£269
FORTRAN COMPILER.....	£220.00	WORDSTAR PROFESSIONAL.....	£193
VOLKSWRITER 3.....	£169.00	MULTIPLAN.....	£109
MICRO SOFT MOUSE/WINDOWS.....	£195.00	VP PLANNER.....	£61
MICROSOFT WORD 3.1.....	£310.00	PARADOX VER 1.1.....	£77
LOTUS HAL.....	£115.00	QUICK BASIC COMPILER.....	£75
FUNK SIDEWAYS 3.1.....	£68.00	EXCEL (MICROSOFT) FOR MAC.....	£345
HARVARD TOTAL 2.....	£399.00		
R BASE SYSTEMS 5.....	£499.00		
(SELECTION OF EXTENSIVE RANGE)			
OPEN ACCESS II.....	£575.00		
OPEN ACCESS.....	£265.00		
SMART SYSTEM.....	£399.00		
SMART SPREADSHEET.....	£299.00		

IBM COMPATIBLE EXPANSION
PRODUCTS AST/PERSYST/EVEREX/
TECMAR/GENOA/OMEGA/
QUADRAM/ORCHID/PARADISE

GOODS FULLY GUARANTEED. PRICES EXCLUDING VAT (P&P EXTRA ON ORDERS
UNDER £300.

Company and Government orders accepted by telephone.
Barclaycard Access Visa accepted by phone.

Tel: 01-455 9823
MOUNTAINDENE

22 Cowper Street, London EC2

→ circle 147 on enquiry card ←



THE FLEXIBLE ANSWER TO INFLEXIBLE BUSINESS PROBLEMS

There's no guarantee of success in business today — not even in the computer industry! But you're more likely to survive if you can be flexible and respond rapidly to pressures as they arise. You certainly can't respond rapidly if you run software that is inflexible, limiting the speed at which you can handle proposals or analyse valuable information on your clients and new market opportunities.

Run the LEX business system from Ace Microsystems and discover what it's like to be really flexible. LEX is a powerful word processing system, fully integrated with a database and a system generator facility that lets you write your own business applications whenever the need arises.

To make you more flexible. To help you succeed.

ACE Ace Microsystems Ltd, Kew Bridge House
Kew Bridge, Brentford, Middlesex TW8 0EJ
Telephone: 01-847 4673 Telex: 929460 ACESYS

LEX
SOFTWARE

→ circle 148 on enquiry card ←

FLOPPY DISKS INCREDIBLE VALUE FOR MONEY £12.00 for a box of 20

5.25 inch, Double Sided, Double Density, Soft Sektored, 48 TPI diskettes with error free guarantee. Branded diskettes of this quality are usually three times more expensive.

500 diskettes for £275.00
1000 diskettes for £500.00
over 2000 ring for quotation

Postage is free but please add 15% V.A.T. to the total for all orders and allow 21 days for delivery.

Please send me.....box(es) of disks (20 per box).

I enclose a cheque for £.....including 15% V.A.T. made payable to ASLAN Computer Services Limited.

Name:.....

Company:.....

Address:.....

Post Code:..... Tel:.....

ASLAN Computer Services Limited, 27 Ketelbey Rise,
Hatch Warren, Basingstoke, Hants RG22 4PE.
Tel: (0256) 53209

→ circle 149 on enquiry card ←



FLOPPY DISKS

All prices plus VAT
Free delivery

		PRICE EACH UNIT			
		10-40	50-90	100+	
8"	DSDD	FD2D	2.25	2.13	2.00
	SSDD	MD1D	1.11	1.04	0.99
	DSDD	MD2D	1.30	1.23	1.16
5 1/4"	DS96TPI	MD2DD	1.57	1.48	1.40
	DS1.6MGB	MD2HD	2.46	2.33	2.19
	55250K	MF1D	1.65	1.57	1.47
	55500K	MF1DD	1.94	1.83	1.73
	DS 500K	MF2D	2.19	2.08	1.96
3 1/2"	HD1000K	MF2DD	2.39	2.26	2.13
	NEW DS1.6MB	MF2HD	5.04	4.88	4.72

Polanka Video Limited
Unit X5 · Acton Business Centre
School Road · London NW10 6TD
01 965 4413

→ circle 150 on enquiry card ←



Whose hand on the reins?

As desk-top computers become more capable, multi-user operation emerges as a realistic proposition. Steve Malone looks at the competing operating systems which can harness and distribute this new-found processing power.

Every year it seems the prophets of Unix have proclaimed that "this is the year". Just as regularly the year goes by with another shower of DOS-based applications, and Unix is again left waiting in the wings. The rest of the industry can therefore be forgiven for ignoring the latest proclamations of Unix's advent as a major force in the business market.

Yet 1987 might truly prove to be the year that Unix supplies evidence that it is to be taken seriously as a mainstream microcomputer operating system. Several new factors have emerged in the last few months to lead to this conclusion. Some are coincidental while others have been engineered, but together they have given significant momentum to multi-user microcomputer systems in general and Unix in particular.

The first pointer is not to do with software but with hardware. For years now, one of the prime criticisms levelled at multi-user systems as compared with networked microcomputers is that sharing the processor between a number of users leads to an unacceptable deterioration in the service provided by the system to each terminal. The development of 32-bit microprocessors such as the Intel 80386 and the Motorola 68020 will largely silence this criticism. We take a look at one of the multi-user upgrades to the Compaq Deskpro 386 on page 91.

The second factor that has emerged in the past year has been the attitude of the hardware manufacturers. Cajoled and bullied by

government agencies from Washington to Brussels, all the major builders of micros and minis now offer Unix on their machines, at least as an option. The most public demonstration of this is the X/Open initiative. As we explained in the May issue of *Practical Computing*, this is a group encompassing 11 companies who have come together to formulate a standard version of Unix. Each member has implemented an agreed subset of Unix on a range of mini and supermicro machines. X/Open has standardised around Posix, which is the IEEE version of AT&T's System V Unix and is therefore independent of any particular manufacturer.

The final factor that has emerged is perhaps the most significant. AT&T, Microsoft, the Santa Cruz Operation and Interactive Software — which are already the four leading Unix suppliers — have announced that they intend to develop a common version. Short of a large user base crying out for products this is the strongest possible incentive for software houses to write Unix applications. Not only have all the major players in the Unix market joined to form a standard, the existence of a single version of the operating system eliminates costly porting and verification procedures. We look at the implications of this standard edition version of Unix on page 30.

Although the smart money is on Unix to become the standard multi-user operating system, there are other products still in the race. The continuing absence of a multi-user

version of MS-DOS or OS/2 leaves the field wide open for other manufacturers to come up with a multi-user operating system for the industry-standard microcomputer architecture. Perhaps the best known of the alternatives is Digital Research's Concurrent DOS, which we examine on page 92.

For the end-user who is familiar with MS-DOS, Concurrent DOS has a lot of attractions. To begin with, DR's offering has over the years become increasingly compatible with MS-DOS. As a result a wide range of applications — the lifeblood of any operating system — have been able to run under Concurrent DOS without modification. A number of Concurrent DOS commands work in exactly the same way as their MS-DOS equivalents, so users need less retraining.

Concurrent DOS offers multi-tasking as well as multi-user capabilities. A number of OEMs have been tempted by these features to offer Concurrent DOS as the operating system for Intel-based multi-user systems although there are several technical drawbacks to this approach. Most of them arise from the fact that many MS-DOS applications are written for single-user operation on stand-alone micros. They therefore take the sort of liberties with the operating system and the hardware that are not possible with a multi-user multi-tasking system.

Even worse, from Digital Research's point of view, many of these applications — Auto-

(continued on next page)

(continued from previous page)

cad, Lotus 1-2-3 and Sidekick, for example — are leaders in their field. Concurrent DOS has therefore been left with well-behaved but outdated products like Word-Star and Supercalc II.

The dark horse in the multi-user race is Pick, which we look at on page 93. On the face of it Pick is the answer to an application writer's prayer. It is fast, adaptable and friendly, and anyone with a little knowledge of Pick could bolt together a customised multi-user environment for an end-user in a few hours.

Pick is an ideal operating system for databases and similar applications. It grew out of a stock-control system for use by personnel with little or no knowledge of computers, and was custom built with that in mind. Many of Pick's features correspond closely with the kind of architecture you might expect to see in a database manager application. It also has its own built-in version of Basic tailored to work closely with the structures of the operating system.

The drawbacks to the system are painfully evident. Few people have heard of Pick and fewer know much about its capabilities. You can get Pick to run on the IBM PC, but there are precious few applications written for it. Pick is in the position now that Unix was a decade ago: heard of, available on a range of machines but barely relevant to the mainstream business market. What Pick lacks is the kind of corporate backing that Unix has. The major supplier of Pick, McDonnell-Douglas, seems to lack the kind of commitment the system needs.

Finally, on page 96 we look at Business Operating Software (BOS). This British-designed suite of programs was originally taken from a mainframe series of packages. Although lacking many of the frills of other systems, its principal advantage is that its applications can run across a varied range of microcomputers. It therefore has some attractions for large business users, as it allows them to upgrade their hardware while maintaining their software investment. Its disadvantages, like those of Pick, are the lack of strong backing and a shortage of applications software.

Unlike stand-alone micros, multi-user systems are not usually installed by the end-user. The overwhelming majority of multi-user systems are set up by dealers or value-added resellers who are called in to solve a particular problem. The end-user neither knows nor cares what the base operating system is: all he or she wants is a working application. The winning operating system in the multi-user arena will therefore be the one that attracts the best applications and the most thorough support.

The move towards multi-user systems is a sign of the increasing maturity of the microcomputer industry. It is further evidence of the blurring of the barriers between the various types of computer as micros take on the role that minicomputers have held for a generation — that of the departmental machine serving a number of users connected to the company data processing system.

UNIX

Steve Malone explains the origins of Unix and looks at the recent developments which have established it as the premier multi-user operating system.

Now that a head of steam is building up behind Unix, the players and strategic alliances which will carry it into the 1990s are beginning to emerge. Not surprisingly, the companies now taking their positions in the network of manufacturers, distributors, support teams and standards bodies are those that have been in the Unix business for many years.

One such company is Sphinx Ltd. It was formed in May 1983 by Pamela Gray and Dominic Dunlop, who were among the first to see that Unix had a worthwhile future. But the trouble with being a pioneer is that you don't have many people around to sell products to, and it was not until 1986 that the founders' faith in Unix began to pay off. The company reported an annual turnover last year of £2.5 million and currently employs 60 people.

Sphinx has been instrumental in setting up the International Consortium for Unix Software (ICUS), a Pan-European group of dealers and distributors. ICUS members plan to co-operate in distributing Unix products, support and services throughout the various countries in which they are represented. ICUS also intends to organise bulk-purchasing arrangements with software houses, particularly those in the US.

Sphinx is naturally bullish about the future of Unix. Ben Salama, the company's

Technical Director, told us: "The arguments that went on two years ago about whether Unix is friendly or not or whether it's better or worse than Pick are irrelevant. The fact is that Unix has been adopted by all the major manufacturers."

Of course, what suits the manufacturers may not necessarily suit the end-users — that is, if Unix is the system they have to grapple with. In practice, Unix is being installed in an increasing number of sites without the end-users realising what operating system they are using. Chris Leak is Sales and Marketing Director of Pegasus, author of the most widely used microcomputer accounts package. He observed: "Xenix is not the beast it's made out to be. The end-users want something to run their accounts, and we have to provide a solution. They don't care what the operating system is."

This experience is borne out by other Unix industry insiders. The Santa Cruz Operation has been in the business of providing Unix-based solutions since 1979, and now claims to be the world's largest vendor of microcomputer-based multi-user software. Jim Wilt, the company's Vice-President for worldwide sales and marketing commented: "The purchasing decision for a multi-user system is usually made by a value added reseller. The user is looking to solve a problem and doesn't care whether it is Unix or DOS underneath. He just goes to the dealer and says 'Solve my problem'."

Unix may be the manufacturers' and dealers' choice, but what kind of advantages does the system offer the end-user? Ben Salama says: "The significance of what Unix is achieving is that it is doing for multi-user systems what MS-DOS did at the low end. It is addressing the issue — from the user's point of view — of how to avoid a situation where they say 'We've got half a million word-processing files which need to be converted to run on the new hardware.' People get locked into the old code; 20 years ago everyone said Fortran was dead, but it's still

CHILD OF MA BELL

Most people agree that Unix is an operating system with a future, but what about its past? Like a number of innovations in computing, Unix originated in Bell Laboratories. It was developed in 1969 by Dennis Ritchie and Ken Thompson, who found themselves working on a DEC PDP-7 without an operating system. Naturally enough, the two men decided to write one, which they called Unix — a name designed to draw comparison with the Multics operating system of the time.

In 1973, the original assembly-language source code for the operating system was rewritten in C, a language which was also invented by Dennis Ritchie. As a result, C became the natural language of Unix — an association which remains today. Bell Labs began introducing the system within its own organisation around 1974, at the same time incorporating extra features to make it more popular in the wider community.

There are now two main versions of Unix out in the field. System III is a non machine-specific version of the system which includes the Programmers' Work Bench and support for 32-bit machines such as the Vax. System V Unix is basically the same but with some modifications developed by the University of California at Berkeley.

The microcomputer industry-standard version of Unix is Microsoft's Xenix. Microsoft licensed this version from AT&T in 1979 and gained permission to make the necessary alterations to render it more approachable for the business user. Xenix is available across the range of Intel processors and on most 16-bit processors, including the 68000.

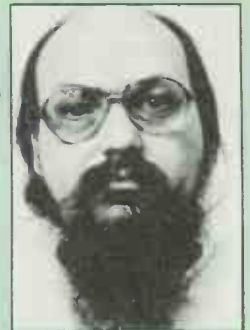

MULTI-USER STRATEGIES



At the end there will be one product — it is likely to be called MS-Unix — which we are hoping to deliver in the first quarter of 1988. At present we are building Xenix to the point where it can go through the verification suite and come out the other end as Unix.

DAVID SMITH, MICROSOFT

around. What Unix offers is a route for users which allows them to maintain their investment."

The ability to change your hardware while maintaining the investment in software is the central premise behind the X/Open group. To put its worthy theories into practice, the X/Open group has commissioned Sphinx to set up its portability centre. This specially organised suite of machines and services is intended to allow software houses to compile source code for Posix on the various machines which come under the wing of X/Open.

Salama explained how the portability centre will operate. "It will be an environment for all X/Open members with all the facilities and skilled staff to allow software houses to port their applications. Our experience is that it is not a trivial business to port software."

In the United States, even more momentous events have been taking place. By far the most important is the recent joint announcement by AT&T and Microsoft which commits the two companies to developing a standard version of Unix for the Intel 80386 processor. The new version will be called Unix — a fact which is far from trivial.

Unix is a trademark of AT&T, which in the past has jealously guarded its rights to the name. Previously, if an OEM bought the source code from AT&T and changed the code in any way, it could not be called Unix. Therefore when Microsoft licensed Unix and tailored it to the business environment, it had to be called something else.

Dave Smith, Microsoft's resident Xenix

guru in Britain, explained the background to the announcement. "We had problems convincing people that Xenix really was Unix System V. About 18 months ago AT&T came up with a verification suite, which people said we hadn't passed. But it should be understood that the verification suite is huge, covering everything from the mainframes and minis down to micros. We passed verification for our end of the market. We are System V compatible at the PC end.

"We found that AT&T was doing a port to the 386 and so were we, so it made sense for us to combine our efforts. At the end there is going to be one product — the feeling at the moment is that it's going to be called MS-Unix — which we are hoping to deliver in the first quarter of 1988. At present we are building Xenix to the point where it can go through the verification suite and come out the other end as Unix."

The version of Unix-386 currently being developed by Microsoft will become the standard version. But this does not mean that in future all copies of Unix-386 will be identical. Microsoft will sell licences to the operating system, which will be customised by OEMs for their own particular market. All the changes will be in the user interface. Software houses, on the other hand, will write to the kernel, which will be identical in all cases.

The Santa Cruz Operation (SCO) is Microsoft's second source for Xenix, as well as being its retail outlet. SCO has specialised in creating value-added versions of Xenix with additional drivers and functionality not provided by the basic product. The company claims that at the moment it sells in the region of 400 Xenix licences in the UK each month. Considering that SCO estimates worldwide monthly sales to be between 2,000 and 2,500 licences, the UK is undoubtedly one of the largest markets for Xenix.

The SCO version of the unified Unix will contain additional device

drivers, an improved system administrator and a graphics library. It will also provide support for a range of different peripherals, such as laser printers. The unified Unix will not be available until next year. At the moment, both SCO and Microsoft are working on a version of Xenix for the PS/2 range, which they hope will become available this autumn.

Meanwhile IBM has announced that it is to provide Aix — its own version of Unix — for the PS/2 machines. In typical fashion IBM is remaining tight-lipped about the kind of features that Aix will contain, and is not likely to make an announcement until the end of the year. Only then will Microsoft and SCO be able to make a judgement on the effect IBM's intervention will have on sales of their own product.

(continued on next page)

The arguments that went on about Unix two years ago are irrelevant. The fact is that Unix has been adopted by all the major manufacturers. It is doing for multi-user systems what MS-DOS did at the low end. Unix offers a route for users which allows them to maintain their investment.

BEN SALAMA, SPHINX



Unix Software

Unix may be the system of the future. But end-users want to know whether applications are available that will increase office productivity. Steve Malone takes a look at some of the Unix software now on the market.

LYRIX 5.0

As Microsoft's major retail outlet for Xenix, the Santa Cruz Operation has a large say in the future direction of the operating system and the applications that go with it. Lyrix is SCO's word-processing package, and it runs not only under Microsoft's Xenix but also under IBM's version of the operating system. It was, in fact, the IBM version that we used for this review.

Lyrix requires a minimum of 384K of RAM and 1Mbyte of disc space. The installation procedure will seem somewhat arcane to anyone unfamiliar with Unix, but the manual provides a step-by-step guide, and most people should be able to get Lyrix up and running in 10 minutes or so.

Lyrix is a menu-driven program. The opening screen provides a list of the main options, from which you can choose to edit a

document, list files in the current directory, use electronic mail or perform file-management tasks. You choose selections either by pressing the first letter of the appropriate command or by scrolling through the list of options with the arrow keys and selecting the highlighted option.

The Edit option presents you with a list of files in the current directory; selecting one of them or typing in a new file name moves you on to the Edit screen. At this point you begin to appreciate the benefits of having an operating system that works in Protected mode on a PC/AT: the computer response is lightning-fast.

In line with Unix's austere image, the Lyrix Edit screen is fairly bare. A single status line at the top of the screen shows the file name, page length, page number and cursor position. Immediately beneath it is the ruler line showing tab and margin positions.

The basic editing commands of Lyrix are

primitive compared with the user-friendly features of modern DOS-based packages. The program makes extensive use of Escape and Control command sequences to perform most of the editing functions. Even worse, the characters chosen do not always bear an obvious relation to their function. The command to move to the top of the screen is Ctrl-T and to the bottom is Ctrl-B, while to save a file you use Ctrl-X.

The Escape characters also take a little getting used to, partly because you press the Escape and alphanumeric keys in sequence, not simultaneously. For example, help is invoked by pressing Escape followed by h; pressing both together generates an error message. Even odder are some other commands like the block move. You mark a block by pressing Escape twice — once for the beginning of the block and again for the end. Pasting a block is then performed by pressing Escape and *.

SPECIFICATIONS



LYRIX 5.0

Description: word-processing application

Hardware required: IBM PC/AT with 384K RAM and hard disc

Unix versions: SCO Xenix V or IBM PC Xenix version 1 or 2

Copy protection: none

Price: £595

Publisher: Santa Cruz Operation Inc., 400 Encinal Street, PO Box 1900, Santa Cruz, California 95061, USA. Telephone: (US area code 408) 425-7222

UK distributors: Sphinx, Level V Distribution, Tetra Business Systems

Available: now

INFORMIX.SQL

Description: relational database-management program

Hardware required: IBM PC/XT or compatible with 512K RAM, 40 Mbyte hard disc

Unix versions: SCO Xenix V or IBM PC Xenix version 1 or 2

Copy protection: none

Price: £1,575 including one-machine licence

Publisher: Relational Database Systems Inc., 4100 Bohannon Drive, Menlo Park, California 94025

UK distributor: Sphinx

Available: now

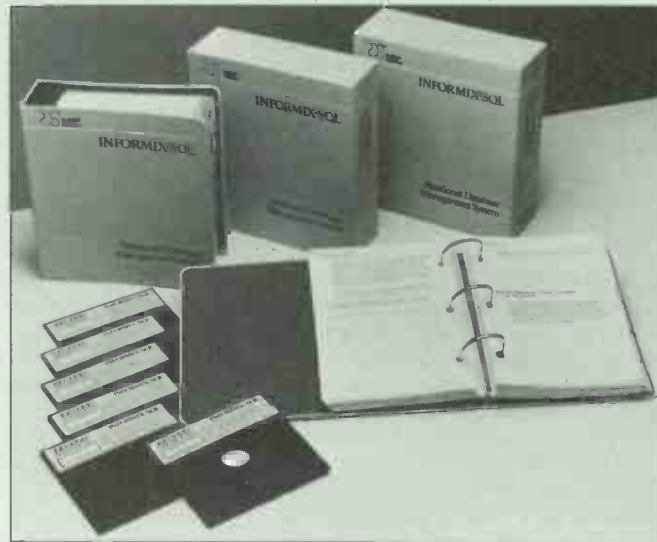

SCO PROFESSIONAL

Description: integrated spreadsheet, graphics and database program

Hardware required: IBM PC/AT or compatible with hard disc and 1Mbyte of RAM; maths co-processor recommended

Unix versions: SCO Xenix 286 3.0/System V or equivalent

Copy protection: none

Price: £795

Publisher: Santa Cruz Operation Inc., 400 Encinal Street, PO Box 1900, Santa Cruz, California 95061, USA. Phone: (US area code 408) 425-7222

UK distributors: Sphinx, Level V Distribution, Tetra Business Systems

Available: now

UK DISTRIBUTORS

Sphinx: 43-53 Moorbridge Road, Maidenhead, Berks SL6 8PL. Telephone: (0628) 75343

Level V Distribution:

Ashford House, Darley Dale, Matlock, Derby DE4 3BT. Telephone: (0629) 733141

Tetra Business Systems:

Unit 5, Foundation House, Norrey's Drive, Maidenhead, Berkshire SL6 4BX

MULTI-USER STRATEGIES

The reason for this apparent madness lies in the multi-user nature of the software. A program designed to run as a multi-user application has to accommodate a wide variety of terminals, not all of which will have function keys and cursor keys. As with the old CP/M programs, the programmers have to use a common subset of keys.

The extensive use of Control and Escape characters might lead you to believe that you are dealing with some mutant version of WordStar. This feeling is encouraged by the fact that Lyrix requires you to use a Reformat command when resetting margins within a document. While the use of Control keys is an understandable necessity, the need to reformat manually is not. SCO says that version 6.0 of the program, expected at the end of this year will adjust to margin settings automatically.

Lyrix also contains WordStar-like dot commands, which are used mostly for messages to be sent to the printer to format a document. For example, dot commands are used to set the number of lines in a footnote, force a page break and merge files at print time. Printing itself is performed via the Print and Mailmerge menu. Before the document is sent to the printer it is possible to format it, using either the Viewprint or Mailmerge sub-menus.

From the Viewprint menu, the user can, among other things, generate a table of contents and reset the margins. The Mailmerge menu, as its name suggests, allows the document to be merged with a list of names and addresses for mailshots and other distribution. Lyrix can use a range of local and remote printers, and from the main menu you can transmit documents as electronic mail.

For a word-processing package the term "multi-user" is a bit of a misnomer; it is hard to imagine any situation where two people would want to work on the same document at once. What the user wants is a program that can be called up from a number of different terminals. For this mode of working Lyrix is adequate, and it should appeal to those familiar with WordStar. However it is an indisputably old-fashioned piece of software. Microsoft is currently developing a Unix version of its best-selling Word package. Without a radical overhaul, Lyrix may soon find itself swamped by the Microsoft product.

SCO PROFESSIONAL

One of the troubles with Unix has been that its applications programs are often quite different from those seen in the DOS universe. It has therefore been difficult for end-users to migrate upwards from DOS. This is now changing as products begin to appear in both DOS and Unix formats. Many of the most popular MS-DOS programs have their Unix look-alikes, and DOS-based data can be transferred into the new Unix programs without modification.

(continued on next page)

ADAPTING A MICRO FOR UNIX

Once you have been sold on a Unix-based multi-user system you still have to decide what kind of hardware to use. The choice comes down to whether you wish to buy a dedicated Unix box with everything already installed, or whether to use a customised IBM-compatible machine. There are good arguments for either course.

In a dedicated multi-user machine all the components will have been tuned to work with each other to provide a turnkey system that is ready to run. But the result of fierce competition in the PC-compatible market means that customised PCs are often cheaper, and have additional features. In this article we look at an add-on that transforms a standard AT-compatible micro into a multi-user engine. We decided to run it with a Compaq Deskpro 386; anything much less powerful is unlikely to make a satisfactory basis for a multi-user system.

The system we looked at was the AT-8 from Chase Research. As the name suggests, the package is designed to turn a basic AT-compatible computer into an eight-user machine. Chase says that two AT-8 cards can be fitted into a single AT compatible; this gives you a maximum of 17 users if you include the computer's own terminal. An IBM System/36 minicomputer supports half the number of users and will set you back twice as much. The AT-8 hardware consists of a plug-in card plus a distribution block and cable. The card fits any available 16-bit full-length slot. The cable from the distribution block plugs into a 25-pin socket on the back of the card. The distribution block itself is simply a box carrying eight RS-232 25-way sockets — one for each of the terminals.

One of the major concerns for the designers of any multi-user system is what is referred to as I/O overhead — that is, the work produced and the number of terminals. If the overhead becomes too great, the CPU unit spends most of its time servicing the terminals, so not much data-processing gets done. Chase Research has gone to some lengths to off-load as much of the I/O as possible to the card. The interface board is in fact a microcomputer in its own right, complete with its own 80186 processor and real-time ROM-based operating system. There are also four Zilog Z-8531 Universal Asynchronous Receiver Transmitter (UART) chips, each of which handles the basic I/O for two terminals. Information entering the interface board is received by the UARTs. They are in turn polled by the 80186, which transfers the data to the board's 32K static RAM buffer.

The final constituent that optimises the performance of the system is the 80186's ability to access directly the computer's main memory. When the AT-8 was designed, the intention was to use it with a 6MHz AT. A considerable performance gain arose from a dedicated processor handling the access to main memory from the card buffer. However, with a machine which uses an 80386 running at over twice the speed, the performance gain is a lot less, although probably still worth having.

Chase Research recommends that you run the Santa Cruz Organisation's version of Xenix with its system. Once Xenix has been installed as a single-user system, the AT-8 installation software can be run from the Superuser directory. Because the installation software has been written with SCO Xenix in mind, the system knows which discs to ask for if particular files are not present. The whole rebuilding procedure to turn Xenix from a single- to multi-user system takes about five minutes on the Deskpro 386.

Each terminal can then be set up for operation. The system supports a range of industry-standard terminals, including Wyse, DEC and ASCII formats. On the review system we used Wyse 60s with a transfer rate of 9,600 baud. We found very little difference in performance between single-user and multi-user operation, even with the full nine terminals running. Users accustomed to a standard IBM PC may even find that things move somewhat faster on the multi-user Unix system.

We noticed a slight delay when all the terminals made simultaneous disc access, but this is probably the result of a bottleneck at the disc drive rather than a consequence of I/O overhead. The situation would presumably get a lot worse if two boards were fitted, although it is unlikely that simultaneous access from 17 terminals would occur very often. Unix's need for virtual memory management — and hence frequent disc accessing — could be alleviated if extra memory were provided within the micro itself. This is worth considering if you are planning to hang a lot of terminals from your CPU.

The AT-8 costs £1,195. It is distributed in the UK by Specialix Systems, Clareville House, 47 Whitcomb Street, London WC2H 7DH. Telephone: 01-930 6971.

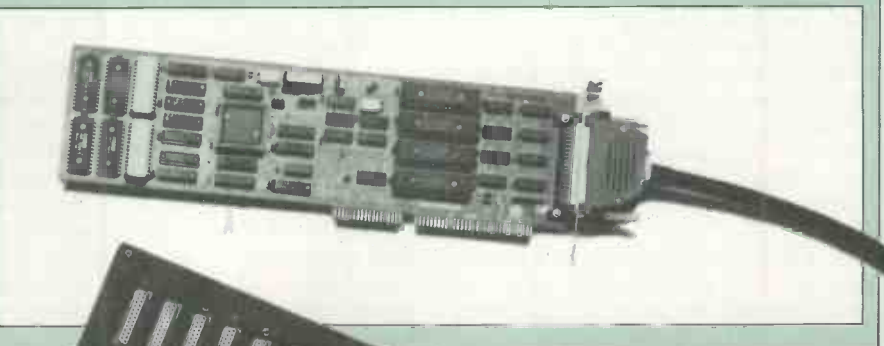

(continued from previous page)

One such program is Santa Cruz's SCO Professional. Although it is entirely Unix-based, it has been designed to perform in exactly the same manner as Lotus 1-2-3. SCO's installation systems try to ensure that setting up the system on your hard disc is trouble-free: you simply copy the Install program across and run it. From then on, the program automatically copies the relevant files and prompts you for the appropriate discs.

In our brief examination of SCO Professional's facilities, all the standard Lotus 1-2-3 commands worked as they should. Data is typed in at the command line on the top of the screen and appears in the appropriate cell when you press Return. The list of commands appears when you press the / key. The graphing function works exactly as it would if the program were 1-2-3 proper. Our only quibble was that SCO did not add any extra functionality to the basic 1-2-3 features and interface. But then a simple clone is probably all that users want.

The lightning-fast response we became accustomed to when running other Unix applications seems to have been lost when it comes to SCO Professional. There is a distinct delay between pressing a key and the execution of the command, although once the command has been executed the display appears as fast as ever.

Santa Cruz says that by reconfiguring the system you can read Lotus WKS and Symphony files directly into SCO Professional. You set the defaults for either the terminal, a graphics device, a Unix device or a DOS device. By setting the DOS device as A you can read DOS files from the floppy-disc drives.

A spreadsheet is not likely to be used for transaction processing. The nearest you are going to get is consolidating several worksheets into one. The real significance of SCO Professional lies in its 1-2-3 compatibility. Such is the dominance of Lotus 1-2-3 in the DOS universe that the credibility of Unix in the business community is bound to be given a boost by a compatible package.

INFORMIX SQL

One of the most valuable applications on a multi-user system is the database manager, since databases lend themselves particularly well to the kind of transaction processing provided by the multi-user layout. A typical system might contain four clerks, each one updating records. With a single processor handling all the terminals, fields and records can be updated in a sequential and orderly fashion, with each clerk using an entirely up-to-date list.

Informix-SQL from Relational Database Systems (RDS) is one of the more popular database packages available to run under Unix.

The first thing to be said about it is that it is not the sort of program where you simply shove a disc into the drive and type Install. The rigmarole required to get it up and run-

ning is the kind of thing that gives Unix a bad name. As well as transferring files in the normal way you have to use the editor to alter the group and user configurations. There is not much in the procedure which could not be included in an automatic install program; but since most Informix installations will be performed by VARs, having to do the job manually most probably does not matter very much. All the same, VARs might like an easy life too.

Informix is every inch the model of a modern relational database manager. It lets you create your databases and customised forms, perform relational operations on the database, and write reports using collated data. The program is entirely menu-driven. The opening screen presents you with a list of options running across the top, rather like that used in Lotus 1-2-3. As in Lotus, you scroll across the options using the arrow keys or the space bar. When an option is highlighted, a line underneath gives a list of sub-options or further explanation of the option. If you get stuck, help can be accessed at any time by pressing Ctrl-W.

The menus continue to provide assistance as you create the database. Each database can be given a name up to 10 characters long; the program makes no distinction between upper- and lower-case letters. Informix supports the use of transaction logs to keep track of changes to the database. It is a useful security device in case anything goes wrong — allowing the database to recover from uncompleted modifications, for example.

Informix is centred on sets of data, called tables, organised in rows and columns. To build the tables you use the Create Table command from the main menu; a database can be made up of any number of tables. The Create Table option allows you to set up a skeleton of the database in which you specify the name of the field, its type — whether serial or character — the field length, and so on. Once the table has been created you can create the screen forms for data entry.

Once the data is inside the computer you search for information by typing in a piece of information, such as the name. Informix will then fetch the rest of the data in the record. By including a wild-card character in the name you can do a fuzzy match against your records.

Informix also supports multiple tables, in which a form can use data from several tables. So even if warehouse stocks are held on one table and customers' names and addresses on another, a single form can be used to create invoices.

Data for printing can be formatted using the Report Writer module. An English-like programming language allows you to specify which fields and records are to be used in the report and how the data is to be presented. For example, you can add headings, footnotes and labels to the report pages. This is a fairly straightforward procedure, but most report templates will in any case be devised by the VAR installing the system rather than by the end-user.

CONCURRENT DOS

Digital Research already has a multi-user operating system, but can it survive the onslaught from Unix? Glyn Moody identifies a well-defined niche where it may survive for a while yet.

Digital Research presents a sad picture of a company once indisputably number one finding itself being ever more firmly relegated to the number two position. Its CP/M operating system dominated eight-bit micros as thoroughly as MS-DOS does 16-bit machines, but for most of today's business micro users it is no more than a memory — if that. The launch of OS/2 plus the unveiling of IBM's long-term micro strategy based around that product seems likely to seal the fate of Digital Research in the mainstream business market.

And yet all is not gloom. Forced by circumstances to accept this state of affairs, Digital Research has set about colonising some of the less obvious niche markets which are as yet untouched by Microsoft. For example there is the little-known Flexos operating system, designed exclusively for computer integrated manufacture (CIM) which seems to be increasingly successful in this area. IBM itself has signed an agreement with Digital Research for the use of Flexos. By channelling its resources into such burgeoning areas, Digital Research may well find that it can exist quite happily outside the world of DOS.

An even more striking success is Concurrent DOS, of which some 250,000 copies have been sold worldwide. As the diagram opposite shows, the evolution of this product has been long and convoluted. It was designed to offer full PC-DOS compatibility along with some tasty extras to seduce people away from Microsoft. Early versions of Concurrent DOS were distinctly wobbly, though later ones seem stable and acceptably compatible; Digital Research speaks of 90-plus percent of PC-DOS programs working under its operating system.

The main bells and whistles offered by Concurrent DOS were multi-tasking and — most importantly — a multi-user capability. Digital Research sees the latter element as concurrent DOS's greatest strength. Whatever the virtues or otherwise of MS-DOS, it has never claimed any kind of multi-user capability — except possibly in the shadowy MS-DOS 4 product, which now seems likely to be eclipsed totally by OS/2. Digital Research has capitalised on this, and majored on the multi-user potential of Concurrent DOS.

MULTI-USER STRATEGIES

CDOS DEVELOPMENT HISTORY

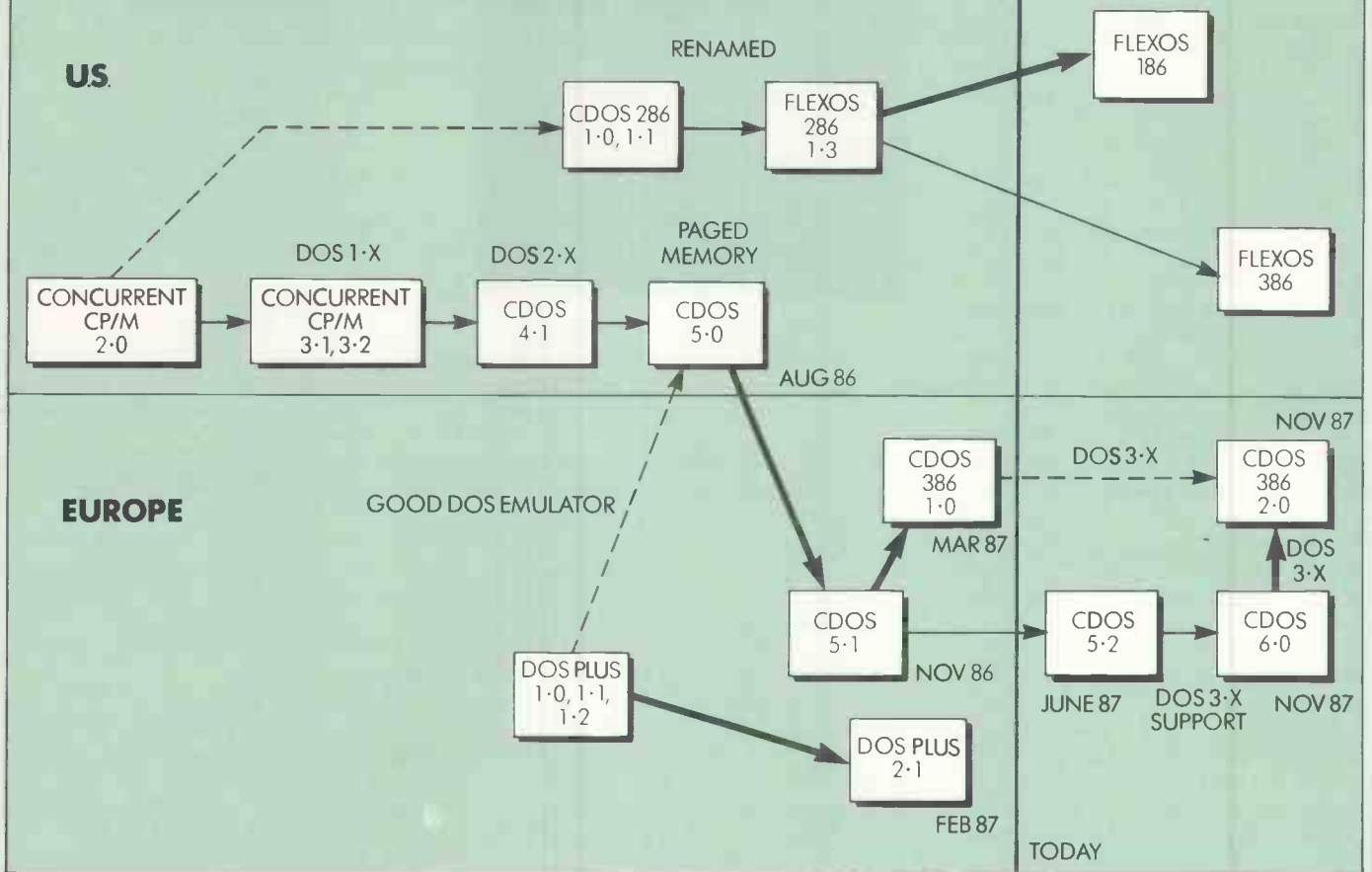

This approach certainly seems to have paid off. According to figures from Digital Research, ICL captured 47 percent of the UK multi-user market in 1986, all of it with machines that use Concurrent DOS. Several other manufacturers also use this operating system, giving it 50 percent of the market. The multi-user market is worth around £100 million overall. The winning strategy seems to be to offer DOS capability in a multi-user environment. These two features neatly define a particular market segment that is, for the moment, more or less immune from attack by rival operating systems.

In an office where there are no more than eight to 10 users, personal-computer software will probably be a desired option. It is not one that is really available on a fully fledged Unix machine, which would in any case be something of an overkill solution. Concurrent DOS offers a neat compromise, retaining a useful level of DOS compatibility so that people may continue to use Word Perfect and dBase III, or whatever their favourites may be. In addition it offers an office-level solution to customer accounts or whatever.

Neat though this picture may be, it does mean that Concurrent DOS is firmly locked into a rather tightly defined sector of the market. The number of offices which fit this bill is rather limited, and likely to shrink as time goes on. If Unix eventually acquires the capability of running DOS applications as a task, the attraction of Concurrent DOS will

be much reduced. Similarly, as the Unix market takes off, good, low-cost applications with DOS-like front ends will start to come through, tipping the balance further in Unix's favour, even for small systems. Perhaps the only enduring obstacle to Unix's success in the small-business work group is its inherent complexity and the need for a system manager.

Paradoxically, Digital Research sees significant opportunities in Microsoft and IBM's announcement of OS/2. The emphasis is on the word "announcement": Digital Research believes that the strung-out timetable for the availability of the various components of DOS — the kernel, the Presentation Manager and finally the applications — should give it a two-year window in which to make significant sales to frustrated PS/2 users.

Digital Research bases its optimism on the neat fit of Concurrent DOS's features with those promised for OS/2. It already has multi-tasking, and furthermore it can multi-task with existing DOS applications; there is no need to wait for programs that have been specially written for OS/2. By contrast OS/2 will only be able to handle one such old-style DOS program at a time. Concurrent DOS has an extended-memory capability, and very shortly there will be a version which utilises the full power of the 80386 chip. Microsoft is not even saying when its 80386 version of OS/2 will be coming through. Clearly it will be some considerable time

after the first 80286 version of OS/2 hits the streets — itself well into next year.

Concurrent DOS possesses very real advantages at the moment, and presumably Digital Research in conjunction with companies like ICL will continue to sell many systems which satisfy users' needs for DOS multi-tasking and/or true 80386 computing. But you cannot help feeling that this is all very interim and stopgap. Once OS/2 and the applications come through — and it is worth noting that the original Windows product was shipped two years after first being shown — it seems likely that the world will split into two camps: the old DOSers running PCs and ATs, and the new OS brigade running PS/2 machines. Once that happens, there seems little reason to go for Concurrent DOS, except in the niche market of low-end multi-user systems. And even that is likely to prove a precarious position.

It will be a sad day when Digital Research is no longer a major player in the world of micro operating systems. In times past, when Microsoft was fresh on the scene, there was a real sense of creative competition between them. As the double juggernaut of DOS and OS builds up an unstoppable momentum in the world of corporate computing, things will become much more predictable. The battle for the multi-user world will still be raging, but it is unlikely to be won by Digital Research with its present range of products.

(continued on next page)

Thinking of Pick purely as an operating system misses the main point. It is more accurate to regard it as a database like dBase III that just happens to have its own tailored operating system built-in. Pick has all the usual operating system functions, like managing the discs, screen and other peripherals. On IBM-compatible PCs it replaces MS-DOS, taking over all its functions.

When you buy Pick you also get something which in the PC market would normally be considered as a major separate application: a relational database manager with an English-like enquiry language called Access. In addition you get a powerful version of Basic that has several extensions to make it work naturally with the database. Less attractive parts of the bundle include a rather primitive text editor and a flexible but very old fashioned word processor.

All this comes quite cheap. The AT version costs £496 for one to three users or £995 for 10 — the maximum number on an AT. You can also obtain Pick for the Amstrad PC: this version costs £300 and can support up to three users. On some Amstrad machines it is necessary to modify the hard-disk controller, adding about £50 to the cost.

The most important part of Pick is the database. It excels at the same kinds of tasks as dBase II. Small system houses and DP departments use it to knock out quick character-based applications. Full record locking and security features are provided to support multiple users — and of course you can run Pick on a single-user system too.

A recent survey by Digitus showed Pick being used in all the classic accounting and record-handling tasks, like payroll and personnel records. The SDP has a five-terminal Pick system which it uses for membership records. Pick is widely used as the basis for turnkey systems, and users often do not know their system is Pick-based. Kalamazoo and Nixdorf, for example, sell Pick-based accounting systems.

Perhaps Pick's biggest advantage is that applications written in it are very portable. It runs on machines all the way from the Amstrad PC to Vax minis and top-end IBM mainframes. While there are some variations in the terminology of the different implementations it is possible to move data and programs from one Pick system to another without difficulty, whatever the underlying hardware. Users can run the same applications throughout their organisation, however chaotic their hardware purchasing policy.

There is one fundamental limitation, however. Pick is designed to run on hardware which follows the classic multi-user approach of terminals grouped around a central processor. Pick is not suitable for use with PCs arranged in a local area network. So to run Pick you make your PC or AT into a multi-user system by plugging in standard terminals via RS-232 ports. For larger setups, cards are available which put several RS-232 ports on one expansion card. A typical cheap terminal costs under £500.

To install Pick on an AT you need to run Fdisk to partition your disc between Pick

PICK

Ian Stobie explains how this multi-user development environment adds up to something more than a mere operating system.

and MS-DOS. This can be a problem if your disc is already quite full and arranged on only one partition; you have to back up any files you want to keep, and copy them back to the MS-DOS partition. Once you install Pick in its own partition you can switch between the two operating systems by rebooting and running Fdisk again to change the active partition. No live communication is possible between the two environments.

Pick uses a virtual-memory management system, swapping data and applications to and from disc automatically as required. This system is economical with memory, and Pick will run without difficulty within 512K. Pick also holds data on disc in an efficient and flexible way. All records are variable in length: you do not need to specify in advance how long a record will be. Maximum record size is 32K; file size is limited only by the disc space available.

After displaying a copyright statement Pick asks you to log on. The log-on sequence establishes which files you have access to and takes you through a security procedure. Different users can have access to different but overlapping sets of files. For each user Pick keeps a record — called an account — which holds details on file access rights. It may also be used for internal billing in a large multi-user setup. To get into the system you need to know at least the name of your account, and the account password.

Once in, you will normally go straight to the Terminal Control Language (TCL) prompt. TCL corresponds to the command language in MS-DOS, and the prompt is even the same shape as the MS-DOS arrow. From TCL you can run a program, set system attributes and do housekeeping tasks, just as you do in MS-DOS. Pick even has its own equivalent of batch files, called Procs, which let you perform a whole lot of TCL commands together.

To use Access, the Pick database language, you just type Access commands straight in at the TCL prompt. Alternatively you can create extensive Procs consisting of long strings of Access commands. So with a file of customer details called Cust, a typical Access query might be

```
LIST CUST CONTACT COMPANY CITY
PHONE
```

This would list customers on the screen, displaying only the contact, company name, city and phone-number fields; if you do not specify the fields you are interested in you get the whole lot. A bit more sophisticated would be:

```
SORT CUST BY CITY CONTACT COMPANY
PHONE BREAK—ON CITY
```

which produces the same details sorted by city and displayed on-screen in city groups.

You can make numeric and date comparisons. For example:

```
SORT CUST WITH BALANCE > "1000"
AND WITH DATE BEFORE "01/04/87" BY
BALANCE
```

Here Pick will give you full details on the worst of your bad-paying customers. You can also compute fields from other fields, use spreadsheet-like mathematical functions, and control the format of output on-page or on-screen.

Though Access is easy to use for casual enquiries, it is ultimately also very powerful. To get the best from Access it helps to know how Pick organises its data. Together with the data for each file, Pick keeps a matching dictionary. It holds information about the data in the file, such as the field name, and the format and length you want it displayed on the screen. The dictionary also cross-links to other files if the data is to be pulled in or computed at run time.

This structure is flexible. You can change field names without changing the data, or set up synonyms; for example, you could give your Salesmen field the additional name of Rep. Since the command words of Pick itself are held in the same way as other Pick data, you can even do the same thing with them. You could allow Sift, Filter or Winnow in addition to Sort, for example, or redefine the whole Pick system into Spanish for a foreign-language application.

Each user has their own set of dictionaries, so what you do does not have to affect anyone else. You can be using Rep; they can be using Salesmen. But providing you both have the right access codes, you can both be using the same data.

The ability to set up cross-links to other files is what turns Pick into a true multi-file

PICK v UNIX

Bandwagon
Built-in database
Multi-user support
LAN support
Comms
Language range
4GL tools
Ease of use

Pick	Unix
small	massive
excellent	none
yes	yes
Revelation only	yes
poor	good
poor	excellent
good	fair
good	poor

MULTI-USER STRATEGIES

RUNNING PICK ALONGSIDE UNIX OR MS-DOS

Redefining Pick as a database rather than an operating system helps clarify some otherwise puzzling features of the Pick scene. You can run Pick — or more accurately Pick-like clones — under both Unix and MS-DOS. The Unix product is called Universe. At present it is only available on large Unix systems, and it is expensive. The smallest machine presently supported is the IBM RT/PC, though it may well migrate down onto the larger 80386-based machines in the near future.

According to Keith Abnett of Orac Information Systems — which is both a Pick and a Unix shop — if Universe works it should be a highly desirable product. Many users are forced by standardisation policies to opt for Unix. While Unix is rather lacking in tools for building business applications fast, this is just the sort of thing Pick excels at. Pick is weak in communications and language support, which are both strong suits for Unix.

The MS-DOS product is called Revelation. It is available in both single- and multi-user versions, with prices starting at £695. The rationale for Revelation is rather different. Pick itself is designed to run on classic star-type multi-user configurations, where you hang terminals off a PC. Revelation is designed for network use. Many micro users prefer the network approach because it gives each user a full-blown PC.

The choice between Pick itself and Revelation is therefore made for you by your organisation's overall multi-user strategy. For classic star-type multi-user setups with terminals you get Pick; for a local area network you get Revelation. Stand-alone PC users can obviously choose either.

Installation of Revelation is simpler than for Pick proper. You just set it up inside a sub-directory on your hard disc. You can then run it from the MS-DOS prompt. Various



utilities are provided to copy between Pick and MS-DOS formats, and you can import dBase files and use pop-ups. Apart from trivial external differences like the shape of the prompt, Pick and Revelation are very similar.

Unfortunately Revelation is not fully compatible when it comes to transferring applications to or from Pick, though you can generally move the data. Because Pick has been going longer it has many more applications available for it than Revelation. And obviously Revelation only runs on PC systems, while Pick runs on virtually anything. So if full portability matters to you only Pick itself can deliver the goods.

database. Again the dictionary is the key concept. You might, for example, decide to hold your customers' full addresses separately to the customer file itself; this could save space if you have several applications which use the same addresses. In the dictionary for the Cust file you would insert a field called something like Company.Addr which would contain instructions to go off and search the address file whenever a request for Company.Addr is made.

While Pick itself provides all the facilities needed to build many kinds of application, some users may require the greater control of a proper programming language. With Pick you do not have much choice of programming language, but the Basic which comes bundled with the system is very good. Pick/Basic is compiled, and is closely coupled to the database. This means you can get at the same data with either a Basic pro-

gram or Access commands from the TCL prompt.

Pick/Basic has a number of powerful and unusual file-handling commands. You can read complete records up to 32K long into multi-dimensional arrays. Space is allocated dynamically, so you do not need to declare or dimension arrays beforehand. The virtual-memory management system ensures your program does not run out of space. You can then use the special Pick/Basic string-handling commands to extract, replace or delete fields, or insert new ones.

The Pick/Basic Read command is quite startling in its power. If you want details on a customer called Jenkins, for instance, you can just say

```
READ C FROM CUST, 'JENKINS' ELSE  
PRINT "NOT THERE"
```

This will search the file for the name Jenkins, and put Jenkins' record into the

array C if it is there, or print out an appropriate message if it is not.

High-level features of this kind make Pick/Basic a quicker language to write in than standard micro Basics. Development is speeded up further by the ability to use Access commands or invoke Proc macros from within the Pick/Basic program; in fact you can issue any valid TCL command. You can use Access commands to do sorts or record selection for you, or pull in a Proc macro to carry out input validation. You can pass variables across directly, using the Pick/Basic Chain command, or just rely on the common Pick file format. Pick is a multi-user system, so Pick/Basic provides file locking at the record level.

Commercially available Pick application software mainly falls into the accounting and vertical-market categories such as ledger and payroll systems or specialised systems for pharmacists, hoteliers or quantity surveyors. What Pick lacks is the vast wealth of generic productivity software that characterises MS-DOS. There are a few word processors and spreadsheets around, such as Jet and Compusheet, but not a wide choice.

For system tools and languages Pick falls far short of Unix. Skilled programmers can work in the machine-independent intermediate-level code used to implement the operating system itself. C is likely to become available in the near future as part of the effort to get Pick running under Unix. But what Pick lacks is other well known high-level languages. If Pick had had a good

(continued on next page)

```
>LIST ACCOUNT NAME CURR-BALNC WITH CURR-BALNC [CR]  
>SORT ACCOUNT >"10000" WITH CURR-BALNC [CR]  
>LIST-LABEL ACCOUNT NAME ADDRESS (N) [CR]  
>SORT-LABEL ACCOUNT NAME ADDRESS BY BILL-RATE LPTR [CR]  
>COUNT INV WITH PRICE ".30" [CR]  
>SUM FILE4 QUAN [CR]  
>SSELECT ACCOUNT WITH BILL-RATE = "10.03" [CR]
```

You manage your database from the Pick prompt using English-like commands.

MULTI-USER STRATEGIES

(continued from previous page)

Cobol or even a Pascal compiler it would not be as obscure a product as it is today. For practical purposes there is only one Pick business language: Pick/Basic.

But in the area of application generators — or fourth-generation languages, as they are now called — Pick is very strong. Because Pick was taken up primarily by people trying to turn out applications as rapidly as possible it is not surprising that products of this kind have flourished. They usually let you design menus, input forms and output formats on-screen; they then take over and build the rest of the application themselves, shielding you from the details.

Making big waves in the Pick world at the moment is System Builder. It costs £595 for a four-user system for the AT. It is a very powerful application builder, and runs not only under Pick, but also under Revelation. A version is currently under development for Universe, the Pick clone that runs under Unix. This means that provided you stick to System Builder functions, avoiding direct calls to lower software layers, you should be able to create applications which transport right across the MS-DOS, Pick and Unix worlds.

Pick is largely the creation of one man, Richard Pick. It was originally developed as part of a system to manage helicopter spares during the Vietnam war, and the CIA was another early user. System Builder emerged out of South Africa, although the company producing it is now Swiss-based.

Though Pick is now almost 20 years old, Richard Pick remains closely involved with the product. His company tightly controls licensing, and there was a period of intense legal action which held up the commercial spread of the system for several years. All this means that Pick is not a well-known name around the households of the computer community. But on the plus side, Pick has remained more tightly standardised than Unix, and Pick applications are genuinely more portable.



Richard Pick: still in control

SUPPLIERS



Pick Systems 1691 Browning, Irving, Ca, USA. Telephone: (US area code 714) 261-7425. Richard Pick's company and thus the ultimate source of all officially licensed versions of Pick.

Sanderson Computers Station Road, Halfway, Sheffield S19 5GZ. Telephone: (0742) 434373. Large UK supplier of Pick and Revelation, covering the IBM PC and larger systems. Also Pick training courses and complete 68000-based Pick systems built around C.Itoh kit.

Personal Systems 15 Gallows Hill Road, Brackmills, Northampton NN4 0EE. Telephone: (0604) 60281. Specialises in Pick for Amstrad and IBM-compatible systems; a cheaper source than Sanderson for AT Pick.

Orac Information Systems Martin House, 18 Peach Street, Wokingham, Berkshire RG11 1XG. Telephone: (0734) 781372. Large Pick system house which develops applications for end-users, runs training courses, and also sells Revelation and System Builder for the PC.

Logical Choice 3 Newtec Place, 66-72 Magdalen Road, Oxford OX4 1RE. Telephone: (0865) 727946. UK source of Universe, Pick clone for Unix.

ALLM Books 21 Beechcroft Road, Bushey, Hertfordshire WD2 2JU. Specialist Pick bookseller and publisher of *Pick Resources Guide*, £29.95, which details available Pick hardware and software.

Pick Forum Horsley Ltd, Capital House, 20/22 Craven Road, London W2 3PX. Telephone: 01-402 3347. Industry association set up to promote Pick in the UK.

UK Pick User Association Alan Pritchard, City of London Polytechnic, 139 Minories, London EC3N 1NL. Telephone: 01-283 1030 ext 374. User group.

BOS

Glyn Moody discovers why a colony of highly specialised multi-user applications has grown up round this British operating system and looks at its future prospects.

The BOS operating system can claim a presence in the multi-user market that stretches back many years. The evolution of BOS Software — the company which developed it — is an unusual one which sheds light on the nature of BOS and its associated application programs. Both have a number of unique features.

The name BOS stands for Business Operating Software. The product was originally developed some 11 years ago at the large software house CAP. After a management buyout, the first operating system — confusingly named BOS 5.0 — was launched eight years ago. As its name suggests, BOS was designed from the start for business applications — unlike CP/M or MS-DOS, which grew out of the micro-computer enthusiast movement. The first micros on which it was implemented used antique processors like the 8080 and 6800, distant forbears of the 80286 and 68000 of today. It also ran on some minicomputers of the time, such as the PDP-11 and the Series/1 IBM.

BOS is written in Cobol, itself a relic from the past. It is unusual enough for an operating system to be written in a high-level language, and in this case the language was an interpreted one. Normally this combination would mean an impossibly slow response time, but the Cobol used in BOS has special extensions to speed up certain operations, and part of it is in any case pre-compiled intermediate code.

Just as a mainframe language was used to write the operating system, so a number of mainframe ideas were taken over into BOS's design, particularly with regard to file handling. For example, file sizes can be up to 2Gbyte; compare this with the mere megabytes available on many other micro-computer operating systems. The code is compact enough to fit in around 128K of RAM, although more memory allows a more powerful system to be set up. The disc space required is around 512K.

From the start BOS was designed to be a multi-tasking, multi-user system. Release 5.1 introduced networking as well. Because of the nature of BOS, networking and the multi-user systems are set up in a very similar way. It is even possible to run multi-user systems on the network, and to pull in data from distant file servers from any of the users hanging off a single machine. This has obvious benefits in terms

MULTI-USER STRATEGIES

```

PL-AP
F1.....<
F1.....<
Y - HEADER
<
PL V2.0?@           Automatic Posting<
<
- End
<
<
<
<
) ) ) Program title:>> Automatic posting<
    <<
) ) ) Last Amended:>> 11-5-87<
    <<
) ) ) Amended by:>> NIK<
    <<
Z - FOOTER
@                ##
- End
P..... End of Page 1 No. of Lines 10.....
    
```

Above: A BOS/Writer screen. Below: The menu from a new BOS application.

```

COMPUTER A MAIN MENU
-----
Install BOS software. . . . . 1
Personal menus. . . . . 2
  SAMPLE DATA . . . . . 3
  OFFICE SOFTWARE . . . . . 4
  BUG LIST. . . . . 5
  MINUTES ETC.. . . . . 6
  DEV . . . . . 7
Start spooler A02 to 500. . . . 8
Start spooler A10 to 501. . . . 9
Status of spooler A02 . . . .10
Status of spooler A10 . . . .11
COMPUTER B MENUS AND COMMANDS .12
COMPUTER C MENUS AND COMMANDS .13
COMPUTER P MENUS AND COMMANDS .14

Please select a function :_
    
```

of expansion potential. You can start with a single-user system, add terminals, and then hook up extra machines via a network. Data can be swapped between any of the users, and software will run on all the machines, even if they are of different types.

It is this portability which is perhaps the greatest attraction of BOS. Unlike many other operating systems, BOS is available on a very wide range of micros and minis. For example, BOS has recently appeared in a version running on the Vax. This allows users to retain their investment in software as they move from machine to machine.

Another attraction of the BOS range is the consistency of the approach adopted by the application packages. In part this reflects the fact that a large proportion of BOS packages have been written by BOS Software itself. But even third-party suppliers are encour-

aged to use standard formats. There are now something like 300 vertical application packages, with little duplication between them.

Packages written in-house include all the standard general applications such as a word processor, spreadsheet, database and comms. The cost of packages depends on the number of users. For a single user it is around £400; for two or three users £650; for four to 12 £950; and for 13 to 24 around £1,250. Prices for larger numbers of users are negotiated on an individual basis.

The common format amounts to little more than using menus as the basis of packages. In this respect BOS rather shows its age again; its packages tend to make WordStar look modern and exciting. But they do at least possess the virtue of simplicity, and one of the main aims of BOS is to keep all details

of the operating system well hidden from the user. Even for the programmer it is quite hard to get at the nuts and bolts of the system.

BOS is, however, very well-endowed with hooks which allow various aspects to be customised for specific applications. For example, you can adapt the error messages by specifying when and where they will appear on a screen, allowing them to be fully integrated into the fabric of the application.

In many respects BOS Software is a typical British software house. Although it has more sites overseas than in the UK, it is dependent on home sales for the bulk of its income. In serving its rather specialised market it has achieved a steady growth of around 30 per cent compound for each of the last few years. But it remains small; last year's turnover was around £3.75 million, with a profit of just £163,000 after investments for the future had been taken care of.

As far as its long-term strategy is concerned, the company seems likely to continue building on its user base by offering an ever-wider range of vertical-market packages and supporting more machines. For example, a version of BOS which can utilise the Protected mode of the 80386 chip is imminent. The company also sells some hardware: its AT clone, called Foundation, is a badged version of the Wyse 286 reviewed in the October 1986 issue of *Practical Computing*.

BOS is clearly not a mainstream operating system; it has neither the user base of Unix nor the specific attractions of Pick. Portability is its main virtue, but this is becoming less important as the world of micros splits into separate camps based around the Intel and Motorola family of chips. The Babel of silicon chip architectures which BOS successfully negotiated is thankfully a thing of the past. Ease of upgradability is attractive, but again its allure has been undermined by the latest developments in the chip families which have made code upwardly compatible anyway.

Perhaps BOS's strongest selling points are the software and dealers its particular nature has engendered. Because it uses a form of Cobol, and it was written with future application products in mind, BOS has been attractive to developers of small-scale software products serving small markets. The disproportionately large number of very specialised packages running under BOS encourages dealers to develop detailed knowledge of both the operating system and the range of products it supports. BOS Software claims that a high level of commitment and expertise is what marks out its dealers and makes the BOS family of products so attractive.

BOS is never going to make AT&T quake in its boots for fear of what might happen to Unix. It will probably continue to do nicely in the realm of software for footwear manufacturers, chiropractors and suchlike which it currently inhabits. But with time it is bound to become increasingly marginal as far as the main thrust of the multi-user market is concerned.

ALL SYSTEMS GO BUT HOW FAST?

FREE!
DEMO DISK
IBM 5 1/4" Format
(Limited period only)
EXISTING USERS!
Contact us for your
SpeedWrite upgrade.
(Only £45)

If you found a way to save hundreds of hours a year – would you use it?

Yes? Then **MicroCache**'s speed enhancements are for you. **MicroCache** is three software packages in one. All three will, to quote a Shropshire dealer, make your system "go like a freshly whipped ferret". What's more, one of them is absolutely FREE with the other two!

DISK CACHE

Disk caching uses spare RAM to speed up disk accessing by up to 500 times. In normal use expect a two-to-ten fold overall speed improvement when reading from both floppy and hard disks. Most systems usually have plenty of unused RAM, or, add up to 4 Mb for even better performance.

SpeedWrite

New! Allows background writing to disk – dramatically improving performance still further.

Does reading or writing a 200 Kb disk file in under two seconds appeal? Order your MicroCache now!

PRINTER BUFFER

SpeedPrint operates like no ordinary printer buffer. It's up to five times faster, extracting data directly from your application program at up to 50,000 characters per second. Avoid the delays inherent in serial/parallel and built-in buffer interfaces. Ideal for both printers and plotters.

You keep full keyboard control of the printing process at all times. Buffer size? From 70 Kb to 4 Mb can be allocated or shared with the Cache.

SCREEN ACCELERATOR

Faster display updates. Faster cursor movement. Enhances sluggish screens. And it's FREE with **MicroCache**.

FEATURES

- ✓ FAST! ✓ Easy to use. ✓ Completely automatic.
- ✓ Compatible with your software. ✓ No changes to make to your system. ✓ Efficient use of all types of RAM. ✓ Makes RAM Disks obsolete. ✓ You don't rely on any special hardware. ✓ No circuit boards to fiddle with. ✓ All floppy and hard disks supported. ✓ Available for most micros. ✓ Cuts waiting time.



Microcosm Research Ltd
26 Danbury Street
London N1 8JU
Tel: 01-226 9092
Telex: 24263 TARDIS G

To: **Microcosm Research Ltd**, 26 Danbury St. London N1 8JU
 YES! Rush me a FREE **MicroCache** Demo Disk.
 YES! Rush me **MicroCache**. Despatch will be made within 2-5 days from receipt of order. I wish to pay £ by Cheque or Access Card 
 Full refund if not completely satisfied.
 Access Card Number:

Name:
 Company:
 Address:
 Tel No:

- Disk Cache £89.00 SpeedPrint Buffer £95.00
 Cache + SpeedWrite £125.00
 Cache + SpeedWrite + SpeedPrint – ONLY £195.00
 SpeedWrite Upgrade £45.00
 Please add £3 p&p plus VAT at 15%
 Computer Type (PCDOS/MSDOS only)

→ circle 151 on enquiry card ←

AT PORTABLE COMPUTER

20 Megabyte Hard Disk
 3 Speed 80286. High Res Monitor
 Tough and Light.
 Complete with standard expansion slots
 12 months warranty
 Only £1199.00 Plus VAT.

NATIONAL PANASONIC KXP1081 PRINTER

£195.00 Plus VAT

MICROLEDGER II INTEGRATED ACCOUNTS SOFTWARE

Sales, Purchase and Nominal Ledgers
 Written by Accountants
 Multi-User Suitable for most Decent Computers
£99.00 Plus VAT
 With Stock Control/Invoicer
£145.00 Plus VAT
 Demo Disk **£10.00 Plus VAT**
 VHS Video Training Cassette **£15.00**
 Available in English/Arabic and other Major Languages

CASH WITH ORDER PLEASE
 All Major Credit Cards Accepted UK and Internationally
 Export Welcomed
 Purchase Orders Accepted from PLC Cos. Government/Schools

From Data Marketing Limited,
 18 Cardiff Road, Luton, Beds LU1 1PP
 Tel: (0582) 458806. Telex: 94016469 (Mill G)
 Link MBX 19011700

→ circle 152 on enquiry card ←



See us on Stand dBASE A at the PC User Show

dGE

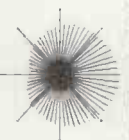

HI RES GRAPHICS ON-SCREEN SETS THE STANDARD FOR PROGRAMMABLE GRAPHICS

dGE — THE database Graphics Extension adds 28 new functions to your database, allowing you to generate hi-res graphs and charts on-screen, directly from your database programs.

Versions available for:-

- dBASE II £90**
dBASE III & III+ £120
dBMAN £120
CLIPPER Compiler £150

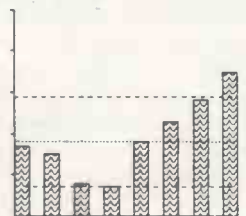
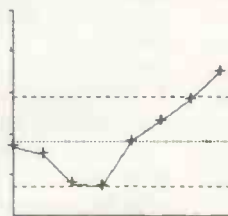

Bits Per Second Ltd.
 17 Guildford Road, Brighton BN1 3LU
 Telephone: (0273) 727119

→ circle 153 on enquiry card ←

EXPANSION CARDS

TOP 10

David Barlow looks at the improvements you can make to your PC just by stuffing a card or two into its expansion slots.

Shortly after the launch of the LIM standard, AST and Quadram announced a more powerful version called the Enhanced Expanded Memory Specification (EEMS). It uses a modified form of paging which supports multi-tasking within a windows environment. Up to nine 512K programs can run simultaneously on a fully populated EEMS system. The trouble with EEMS is that few software houses have pledged outright support for it, but AST and Quadram claim that it is EMS compatible and should run any packages intended for the LIM system.

Both EMS and EEMS are somewhat messy interim solutions to the constraints imposed by MS-DOS. The way forward must lie with extended memory systems which exploit the Protected mode of the Intel 80286 processor used in the AT and its compatibles. This system supports at least 8Mbyte, depending on hardware, and when in place is invisible to current versions of DOS. It is there waiting for OS/2 when it arrives, later this year or early next. In the meantime all users will have to content themselves with using Extend Memory Systems to set up massive RAM discs and print spoolers.

Display adaptors get more and more versatile as the months go by. Latest offerings from AST and Quadram support all known standards, including IBM text (MDA), Hercules, the CGA and EGA colour-graphics formats, and a few specials

It is now possible to transform your PC into a totally different animal to the one you originally bought simply by fitting a selection of expansion cards. Although this approach makes little or no economic sense if you are building up a system from scratch, it is a measure of just how sophisticated the add-on board market has become. It can also be a useful way of giving a new lease of life to old kit. The boards now on the market can be split into five main groups: multi-function, expanded/extended memory, display, modems/communications, and accelerator boards.

While PC manufacturers produce their fair share of expansion cards it is left to the specialist third-party manufacturers to come up with the really innovative devices. Some of these companies have achieved such success in this previously small sector of the market that they have turned into PC manufacturers themselves. AST started the board revolution some five years ago, and has recently launched a very creditable AT compatible, the AST Premium. This machine manages to stand above the rest of the AT crowd largely on the strengths of features developed from AST's memory and display board experience.

Multi-function units are now cheap and plentiful, but the need for them has declined because more and more PCs are fitted with the maximum 640K of memory that can be addressed by MS-DOS. If the motherboard cannot accept this quantity of RAM, then multi-function cards provide a cheap and quick way of expanding conventional memory to this level. They also offer extras like serial ports, parallel ports and clock/calendars as an additional incentive to the owners of the more primitive PCs.

Going beyond conventional memory has proved more lucrative for the board manufacturers in recent times. Lotus, Intel and Microsoft started the ball rolling with their joint development of the Intel Above Board. This product enables certain applications packages to address up to 8Mbyte of RAM by a clever system of memory paging. This standard is often referred to as the Lotus Intel Microsoft Expanded Memory Specification (LIM EMS), and has been widely adopted by the software houses. It is now supported by Lotus 1-2-3 and Supercalc 4, among others.

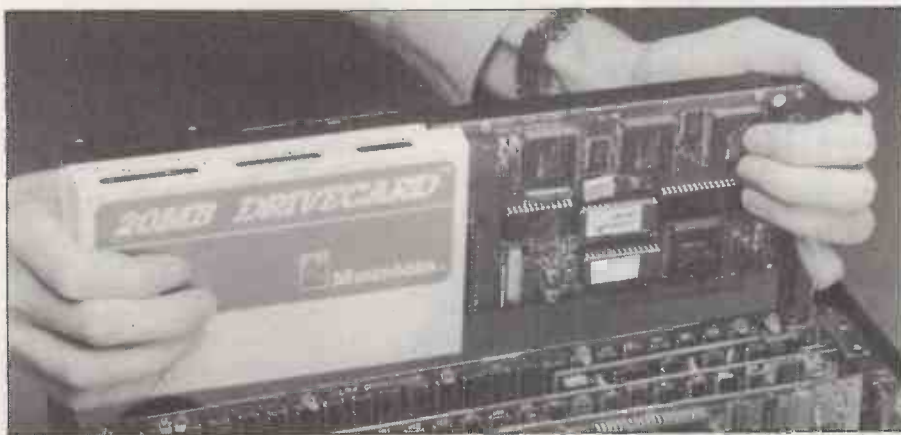

Cards are convenient for upgrading but make heavy demands on the power supply.

thrown in for good measure. The old MDA system has now been laid to rest by all but the most stingy PC manufacturers. The Hercules monochrome standard which has replaced it is now supported by 98 percent of applications packages.

Board modems are a relatively new addition to the card manufacturers' repertoire. It took a lot longer than anticipated for these devices to get the essential BABT approval, but now that they are at last officially blessed they look a particularly tidy way of providing comms hardware. There are no power wires to worry about, the card does not use up one of the existing serial ports, and it can be moved around as an integral part of the PC.

Accelerator boards boost performance by replacing the PC's processor and memory with a more powerful setup, usually boasting a processor from the next generation up. This means that an 8086 machine gets the Intel 80286, and an 80286 machine gets the 80386. Accelerator cards can certainly give performance a tremendous shot in the arm, but in the process they can throw up compatibility problems too. It is at present an expensive option compared to the cost of selling your original PC and buying a more powerful machine. But with respected names like Intel offering their own accelerator boards it is a market that has to be taken seriously.

Although the board market has been extremely buoyant in recent months, IBM's announcement of the PS/2 looks set to stifle development, temporarily at least. It must inevitably take some time for the dust to settle. When it does, a new breed of add-on boards will emerge, but until then manufacturers will have to rely on existing products to keep their businesses turning over.

SUPPLIERS

Allcard All Computers, Prince Rupert House, 64 Queen Street, London EC4R 1AD. Telephone: 01-248 8895

Hayes 1200B Hayes Microcomputer Products, 1 Roundwood Avenue, Stockley Park, Uxbridge, Middlesex UB1 1AE. Telephone: 01-848 1858

Hercules Graphics Card Plus, Intel Above Board, Intel Inboard 386/AT First Software, Intec 1, Wade Road, Basingstoke, Hampshire RG24 0NE. Telephone: (0256) 463344

Irma Computer Marketing, CMA House, Lansbury Estate, Lower Guildford Road, Knaphill, Surrey GU21 2EW. Telephone: (04867) 4555

Mountain Drive Card P&P Micro, Todd Hall Road, Carrs Industrial Estate, Haslingden, Rossendale, Lancashire BB4 5HU. Telephone: (0706) 217744

Number Smasher Microway, 32 High Street, Kingston-upon-Thames, Surrey KT1 1HL. Telephone: 01-541 5466

Quadram EGA Prosync Interquadram, 653 Ajax Avenue, Slough, Berkshire SL1 4BG. Telephone: (0753) 34421

Sixpak Plus AST Europe, AST House, Goat Wharf, Brentford, Middlesex TW8 0BA. Telephone: 01-568 4350

TOP 10

ALLCARD

THE Allcard uses an unusual approach that allows direct addressing for up to 952K of RAM in addition to powerful extended-memory capabilities. It works in a similar fashion to the PC/AT's memory-management unit, acting as a pre-processor to the CPU. By adding four bits to the beginning of the usual memory address it enables the resulting 24-bit address to access up to 10Mbyte of RAM. The most interesting aspect of the Allcard is the way it reconfigures the memory map, so that on power-up the operating system does not see the 640K barrier and will initialise memory up to 952K.

PRICE: £595 for 512K RAM

FOR: Conventional memory to 952K. Extended memory.
AGAINST: Does not conform to an accepted standard.

AST SIXPAK PLUS

PROBABLY the best known multi-function expansion board. It can expand PC/XT memory by anything from 64K to 384K, bringing it up to the full 640K limit. Also included on the board are an extra serial port, a battery-backed clock/calendar, a parallel port and an optional games port for use with joysticks. Along with this wealth of hardware AST also throws in some useful software, including Desqview, a multi-tasking environment that enables you to run several applications packages concurrently. Also supplied is the Sidekick desk-top manager, Superdrive RAM disc and Super Spool print spooler.

PRICE: £470 for 384K RAM

FOR: Good value for extra facilities.
AGAINST: Conventional memory only.

Hercules Graphics Card Plus.

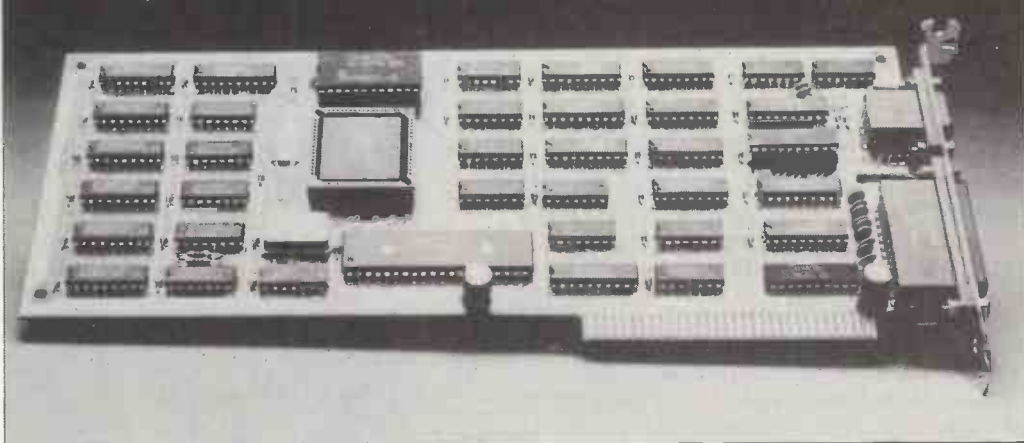

HAYES SMARTMODEM 1200B

THE 1200B is a plug-in board version of the popular Smartmodem 1200 that offers 1,200/1,200 baud CCITT V-22 compatibility. The card simply plugs into an eight-bit expansion slot and does not require external power. The 1200B features autodial/auto-answer, call-progress monitoring, and both tone and pulse dialling. It is available bundled with Smartcom II communications software for a competitive £475; Smartcom is a full-feature menu-driven communications package which supports batch commands, multiple protocols and terminal emulation. The 1200B is sold

with a two-year warranty, and you have the option to extend it for a further two years. Hayes operates a customer-service facility during normal office hours.

PRICE: £425

FOR: Tidy installation. Does not occupy existing serial port.
AGAINST: No status LEDs.

HERCULES GRAPHICS CARD PLUS

THE NEW Graphics Card Plus, which is 100 percent compatible with the original Hercules card, includes a powerful facility called Ramfont. It is a mono-

chrome-only board, and offers resolution as before of a healthy 720 by 348 pixels on all applications packages that have a Hercules-compatible screen driver. Ramfont adds the capability to display characters ranging in size from eight by four pixels to nine by 16 pixels. When used with Lotus 1-2-3 release 2, for example, this can double the size of the visible section of the spreadsheet. The same facility can also be used with Microsoft Word 3, Framework and Symphony. Included with every card is software to extend the life of your monitor, print graphics and display 25 ready-made character fonts. The Graphics Card Plus also includes a parallel port.

PRICE: £245

FOR: Hercules compatible. Ramfont facility.
AGAINST: Monochrome only.

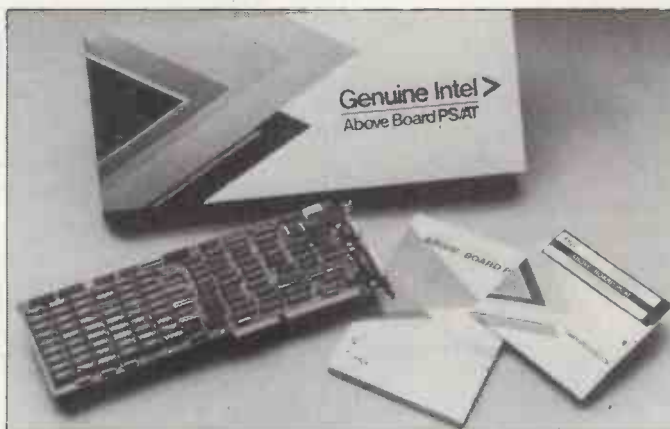

Above: The Intel Above Board. Below: AST's Sixpak Plus.

INTEL ABOVE BOARD

THE board that kicked off the LIM EMS standard. Although not as powerful as EEMS boards from AST and Quadram, boards that conform to the Intel standard can claim more widespread support from software houses. Lotus 1-2-3 was one of the first spreadsheets to support the Above Board, followed by Supercalc 4. Other supporting packages include Symphony, Framework and Microsoft Windows. By the use of memory paging, the Intel Above Board allows supporting applications to break the 640K barrier. This facility is particularly useful for creating and manipulating ultra-large spreadsheets. Each memory board can support up to 2Mbyte of RAM; a maximum of four boards can be installed

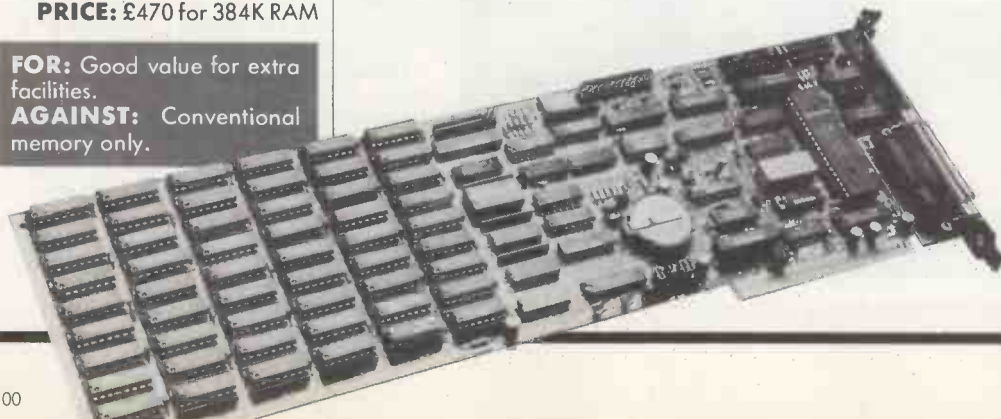

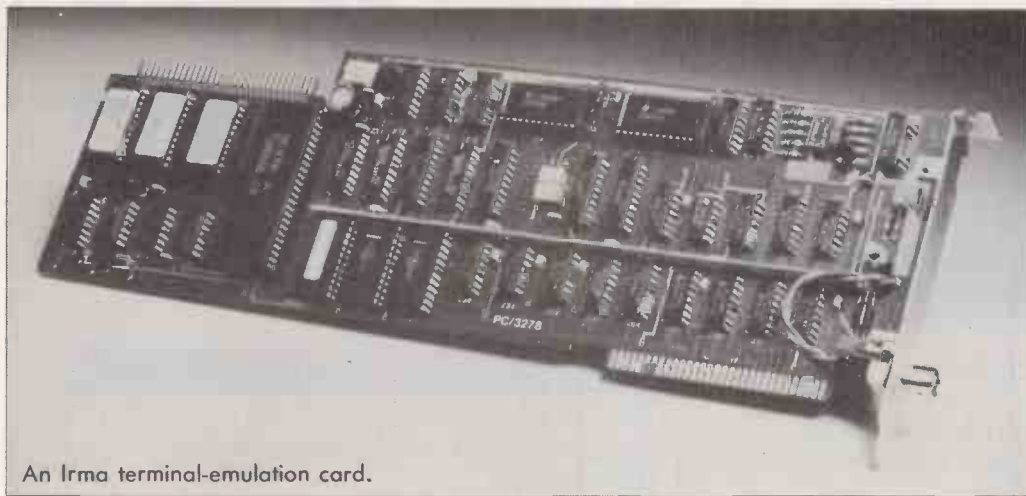

An Irma terminal-emulation card.

in a PC to provide a grand total of 8Mbyte. The extra memory can be used in expanded mode or as a high-speed RAM disc.

PRICE: £615 for 512K RAM

FOR: The standard for expanded memory.
AGAINST: Not as powerful as EEMS.

INTEL INBOARD 386/AT

IT IS claimed that this board offers AT users the performance of 80386-based machines such as the Jarogate or Compaq Deskpro 386. The Inboard 386/AT carries an Intel 80386 processor running at a sprightly 16 MHz, along with its own 1Mbyte of RAM. A further 2Mbyte can be added piggy-back fashion, and the 80387 maths co-processor will be available later on this year. Applications concurrency is another carrot being dangled in front of users, but once again this is on the list of goodies that has yet to be released. The Inboard plugs into any AT expansion slot, but in addition you have to remove your machine's original 80286 processor and replace it with a special plug which hooks in the board's 80386 chip.

PRICE: £2,425

FOR: Performance.
AGAINST: Price.

IRMA

FOR THOSE with the problem of accessing a mainframe system from a micro, the Irma board provides a powerful solution. It adds to the IBM PC, PC/AT and compatibles the features of an IBM 3278 terminal, thus offering a direct link to an IBM main-

frame without sacrificing any of the PC's stand-alone functions. The 3270's coaxial type of interface is easy to install and supports 11 possible IBM keyboards and several different screen formats. File-transfer utilities are included for VM/CMS and MVS/TSO; both provide a binary mode to transfer files containing special symbols, such as those found in BAS programs. Irma can be connected directly to any 3274 or 3276 cluster controller which supports SNA, non-SNA and BSC environments.

PRICE: £1,158

FOR: Micro-to-mainframe communications standard.
AGAINST: Cost. Complexity.

MICROWAY NUMBERSMASHER ECM

COMPATIBILITY problems tend to dog more sophisticated accelerator boards, but the Numbersmasher sets out specifically to avoid them. It amounts almost to a self-contained micro with its own processor and memory on one board. All the processing is done on the board, leaving the PC's own mother-

board to carry out only basic I/O functions. The Numbersmasher is equipped with an Intel 8086 processor, which can run at up to 9.54MHz, coupled to an 8087 arithmetic coprocessor and 1Mbyte of full 16-bit memory. In normal operation the performance of a Numbersmasher-equipped PC lags behind the IBM PC/AT, but when the Intel 8087 comes into play the hybrid setup outperforms the AT.

PRICE: £569

FOR: Performance.
AGAINST: Potential compatibility problems.

MOUNTAIN DRIVECARD

AS THE price of built-in hard discs has dropped in the past year, the price of a hard disc and controller combined on to a PC expansion card has fallen too. The Mountain range is one of the more expensive, but it has an excellent reputation for reliability and support. It is available in both 20Mbyte and 30Mbyte capacities. A Mountain card simply plugs into an eight-bit expansion slot and then requires installation using the software provided. It is thick enough to

encroach on the space of the neighbouring slot, so it must be installed next to a half-length card or an empty slot. Performance is good, though not up to the standard of conventional sub-systems available at much lower prices. However, hard-disc cards allow you to retain two floppies along with your hard disc, and many users find this ample compensation for lacklustre performance.

PRICES: £795 for 20Mbyte
£995 for 30Mbyte

FOR: Convenience. Ease of installation.
AGAINST: Rather sluggish.

QUADRAM EGA PROSYNC

SUPPORT for two additional EGA modes is provided by the Quad EGA Prosync advanced enhanced graphics adaptor when used with Multisync monitors. The 640-by-480 and 752-by-410 modes allow up to 37 percent more data than normal to be displayed on the screen. The EGA Prosync also supports conventional EGA monitor display modes, including 640-by-350, 320-by-200, 720-by-348 monochrome Hercules and 640-by-350 monochrome IBM text. While other adaptors demand complex installation procedures, Prosync's Autoselect system automatically selects the correct viewing mode for many popular applications. Other useful features include softfont character generation, a screen saver and flicker-free scrolling.

PRICE: £349

FOR: Multi-mode compatibility.
AGAINST: Cost. Needs special monitors.

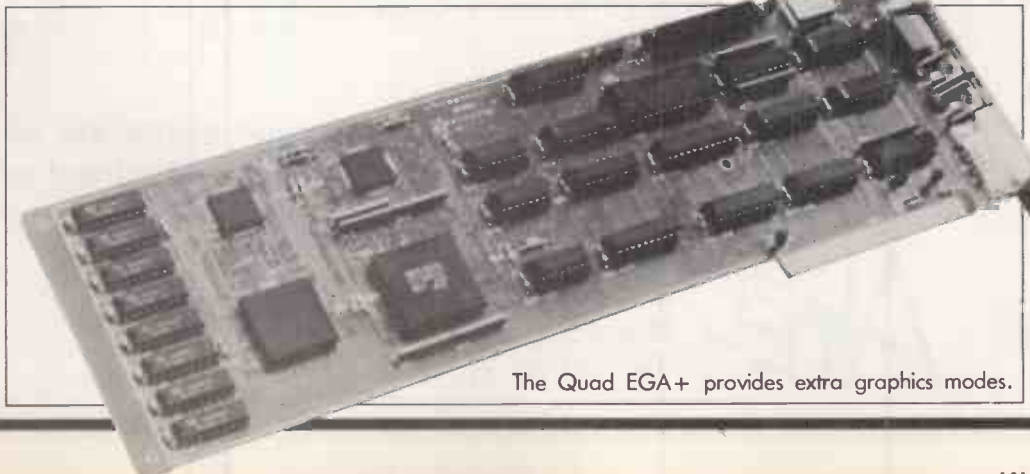

The Quad EGA+ provides extra graphics modes.

WITH FREE SOFTWARE

XT

Single FDD £4.25
 DUAL FDD £4.65
 20 meg + 1FDD £6.99

SPECIFICATIONS

512K RAM, 4.7/8 meg turbo, real time clock, printer port serial port, Hercules compatible monographics, 12 inch Hi-res monitor with swivel and tilt, AT style keyboard, power supply, 12 months warranty.

AT

Single FDD £799
 20meg + 1FDD £999

SPECIFICATIONS

10 meg turbo, real time clock, printer port, serial port, 512K RAM, Hercules compatible monographics, 12 inch hi-res monitor with swivel and tilt, AT style keyboard, power supply, 12 months warranty.

M.USER £399

4 USER, 20 MEG and 12 MONTHS ON SITE MAINTENANCE £3999

SPECIFICATIONS FOR MULTI-USER

Connects to existing and new PCs and ATs 20 min install time for 4 users. Ideal for beginners or expert. Easy to follow tutorial disk, 1-32 users, 256K to 4 meg RAM. High performance 6800 engine plus 8088 slave. 20 meg to 160 meg disk storage O/S is 3.1 Dos or greater. Network is totally transparent to user.

TOSHIBA

3100/10	£2300
3100/20	£2950
1100 +	£1250

DICONIX

150	£320
-----	------

Portable printer using battery/mains
 150 cps draft.

STORAGE

Hard Disc	
20 meg + cont	£265
30 meg + cont	£299
40 meg + cont	£599
60 meg + cont	£649

Streamer

20 meg int	£450
40 meg int	£550

MONITOR

EGA with card	£425
TTL swivel & tilt	£79

CHIPS

4164-15	95p
41256-15	£2.50
41256-12	£2.95
4128	£3.20
8087-5	£80.00
8087-8	£145.00
80287-80	£230.00

AT, XT and MULTI-USER systems come complete with easy to use word processor, database and spreadsheet software.



ALL-TEC LTD,
 84 Highfield Road,
 Romford, RM5 3RU.
 Tel: (0708) 27043

CAMBRIDGE COMPUTER SOLUTIONS

RETAILERS · WHOLESALERS
PUBLISHERS · IMPORT & EXPORT

First Floor
64 Cherry Hinton Road
Cambridge CB1 4AA
Telephone: (0223)
213374
Fax: (0223) 410291

IBM-COMPATIBLE SOFTWARE

WordStar 2000 release 2.....	£231
Wordstar Version 4 — New Features in Old Dress.....	£199
WordStar Professional Version 4.....	£249
Dbase III Plus — Best Selling Professional Database.....	£335
Framework II VER 1.1.....	£313
Lotus 1-2-3 ver 2.1 Top Selling Package in The World.....	£229
Supercalc ver 4 — The Celebrated Lotus-Beater!.....	£197
Smart System — The Best Integrated Package.....	£365
Word Perfect ver 4.2 — The Number 1 WP Package.....	£249
Microsoft Word ver 3 — Number 2 WP Package.....	£270
Multimate ver 3.31.....	£207
Executive Systems X-Tree (Super Friendly HD Organizer).....	£34
Pegasus Accounts (per Module).....	£199
Psion Chess — You too can become like Gary Kasparov.....	£25
Quaid Software Copywrite (Back up Protected Software).....	£39
Lotus Symphony ver 1.1.....	£333
Microsoft Flight Simulator — Don't crash.....	£39
Funk Software Sideways.....	£40
Borland Turbo Lightening.....	£55
Microsoft Windows.....	£59
Lotus Manuscript — Latest Blockbuster WP Package!.....	£290
PFS: First Choice.....	£110
Grafox Logistix.....	£80

DOT MATRIX PRINTERS

Epson LX86 — The Best Seller in the World.....	£195
Star NL10 — The Number Two Seller-Best Spec.....	£210
Star NX15 — The New Wide-body NL10!.....	£291
Star NR15 — Replaces the SR15-A Great Mover.....	£224
Panasonic 1081 100cps & 80 col — Brand New!.....	£249
Panasonic 1091 — Byte Magazine Says It's No 1.....	£228
Epson FX105+ — The Ford Transit of Printers!.....	£375
Epson LQ800 — Letter Quality — 24 Pin Printhead.....	£428
Epson LQ 1000 — Letter Quality — 24 Pins — 132 Col.....	£571
Epson LQ2500 — This one is really good!.....	£725
Epson SQ2500 — Ink your jet with this one.....	£999
Epson FX800 — Brand New! 240cps! Wow!.....	£324
Epson FX1000 — Brand New! Replaces FX105.....	£415
Epson EX800 300cps & 80 column-Super Fast!.....	£385
Epson EX1000 300cps and 136col-Super Fast.....	£517
Star NB 15 — The big, up market Star 24-pin.....	£695
Star NB 2415 — Same as above, just a bit slower.....	£599
Juki 5510 — A Best Seller.....	£265
Seikosha — MP 1300A1 — 300cps! (EX800 clone).....	£302
Seikosha — MP 5300A1 — 132col Version of MP 1300.....	£439
MP 165 — Cheap, fast and good quality 180cps.....	£170
Mp 200 — 200 cps! 132col!.....	£260
MP 201 — 132 col 200cps.....	£295
NEC P6 — Good Buy.....	£395
NECP7 — One of the best sellers ever — 24 pin.....	£449
Oki Microline 182 — The number two brand.....	£205
Oki Microline 192 — Perennial Favourite.....	£299
Oki Microline 193 — Worth a look.....	£369
Oki Microline 293 — Worth a long look.....	£608
Citizen MSP-15 160cps and 18col.....	£329

DAISYWHEEL PRINTERS

Star Power type 18cps — The current cheap one.....	£189
Juki 6100 — 20cps — Very popular.....	£269
Juki 6200 — 30cps — Still popular.....	£437
Juki 6300 — 40cps — Very upmarket.....	£692
Juki 6500 — 60cps — Heavy duty and very fast.....	£966
NEC 8800 — Thimble printer, 55cps.....	£850
Qume Sprint 11/90 — 90cps Daisywheel printer.....	£1200

COLOUR PRINTERS

Okimate 20 thermal printer.....	£159
Juki 5520 — the market leader — fast!.....	£335
Epson EX-Series Colour Option.....	£55
NEC P565XL — Heavy duty office favourite!.....	£780
Epson LQ 2550 Colour Options/Makes LQ2500 Colour.....	£55
Seikosha MP1300 Colour Kit/Makes MP1300 Colour.....	£87

FLOPPY DISKS

All prices plus VAT
PRICE EACH UNIT

	CODE	10-40	50-90	100+
8" DSDD	FD2D	1.91	1.85	1.79
SSDD	MD1D	1.02	0.98	0.95
DSDD	MD2D	1.20	1.16	1.12
5½" DS96TPI	MD2DD	1.43	1.39	1.34
DS1.6MGB	MD2HD	2.25	2.18	2.11
55250K	MF1D	1.37	1.33	1.28
55500K	MF1DD	1.78	1.72	1.66
DS 500K	MF2D	1.78	1.72	1.66
3½" HD1000K	MF2DD	2.18	2.11	2.04
NEW DS1.6MB	MF2HD	5.04	4.88	4.72

HARD DISK & MEMORY UPGRADES

IBM COMPATIBLE Cards/Peripherals at unrepeatable prices

Mother Board W/Legal Blos.....	£98.00
Computer Case Baby at.....	£50.00
Computer CASE AT.....	£60.00
Power Supplies XT (150w).....	£89.00
Power Supplies AT (209w).....	£125.00
Keyboard English XT/AT.....	£75.00
Multi I/D Card 2xRS232.....	£70.00
Colour Graphics Display.....	£89.00
RS232 Card.....	£36.00
Parallel Card.....	£25.00
Hard Disk Card.....	£78.00
I/O Card 2xRS232.....	£25.00 with cable
Hard Disk Drive Seagate 20MB.....	£295.00

Cables and Connectors for your requirements
All prices exclude VAT

Free Delivery for orders
over £50.00 plus VAT

EX STOCK



THE NEW APRICOT 386 and VX SYSTEMS

Supplied by: The Computer Company.

Telephone: 01-882 8811

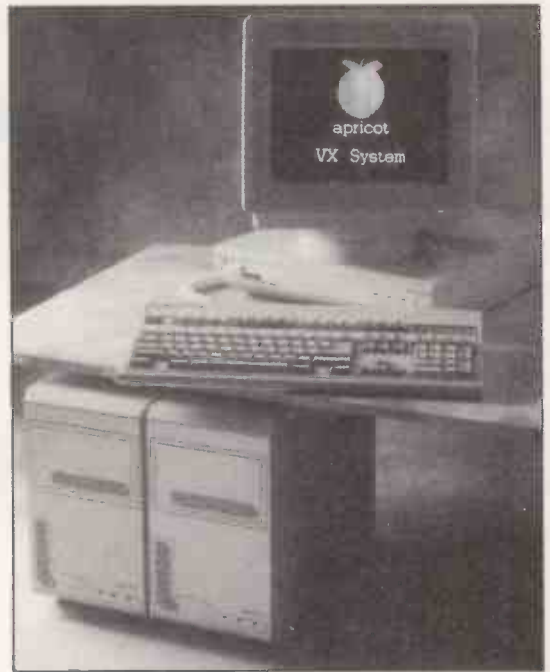

See the complete range of APRICOT systems SINGLE AND MULTI USER in our new showroom (car park to the rear, Southgate tube opposite)

Company Services include:
BESPOKE SOFTWARE
NETWORK PLANNING & INSTALLATION
ON SITE TRAINING
OWN IN-HOUSE TRAINING SCHOOL
CONSULTANCY
FULLY EQUIPPED IN HOUSE
MAINTENANCE WORKSHOPS
ON SITE MAINTENANCE CONTRACTS
AFTER SALES TELEPHONE SUPPORT
We can also provide telephone support for
computer users that have not purchased
systems from us using our annual telephone
support contracts.

The Computer Company

2-16 Burleigh Parade
Burleigh Gardens
Southgate
London N14
Telephone No: 01-882 8811

**APRICOT
PEGASUS ACCOUNTS
SOFTWARE
NOVELL NETWARE
XENIX 286/386**

*Authorised Sales Service &
Support Centre*

IBM

BIG BLUE

By Richard Thomas DeLamarter • Published by Macmillan London Ltd, £14.95 • ISBN 0 396 08515 6

IBM DOMINATES the information-technology industry — too much so. This is the premise behind *Big Blue*. The author, Richard DeLamarter, worked for the anti-trust division of the US Department of Justice for eight years in the case of the US v IBM. The case was finally dropped by the Reagan administration in 1982.

This clearly made DeLamarter bitter, and in the book he presents the evidence for the prosecution which was denied a Federal hearing. Using a wealth of information, a lot of it culled from IBM's own files, DeLamarter sets out to prove his case.

The nub of his argument is that IBM uses its power to squeeze excessive profits from the areas where it maintains a near-monopoly position. The cash generated from the monopoly business is then used to wipe out rival companies in those areas where it faces competition — even where those rival products are superior.

DeLamarter also claims that IBM does everything in its power to evade scrutiny by anti-trust investigators and, while paying lip service to the concept of standards, attempts to circumvent them if they lead to a threat to its position as dominant supplier. The author ends the book by predicting that IBM is poised to take over the world communications industry too, and makes a plea that IBM be dismantled for the good of the information-technology business and all those it affects — that is, every one of us. **SM**

DBASE

THE dBASE III COMPANION

By Peter Gosling • Published by Paradigm, £5.95 • ISBN 0 948825 05 7

THE great advantage of Peter Gosling's book is that it is short; it has 130 pages, but they are not very big. Most dBase books are massive, which makes them quite unsuitable if all you want is a quick guide to what dBase is all about.

Gosling is excellent for this. He writes well, using simple examples which he changes frequently to fit the points he is trying to make, so they do not get tedious. He always gives the output you would get from typing in a particular piece of dBase code, so you do not need to have a machine running dBase in front of you while you read.

You can almost read *The dBase III Companion* like a novel — it should take an hour or two at the most. For this reason, it is a good book to get if you are not sure if you could handle the complexities of dBase and just want a flavour of the system. It is a good deal less intimidating than the colossal dBase III user manual, so it should also help anyone who has had the package thrust upon them, unasked for.

dBase is far and away the most widely used database package. Gosling's book is probably worth the £5.95 if you feel you would like to be able to type at least something sensible when confronted by the dBase dot prompt. **IS**



DTP

THE DESKTOP PUBLISHING COMPANION

By Graham Jones • Published by Sigma Press, £14.95 • ISBN 1 85058 078 2

IN HIS introduction, Graham Jones says that *The Desktop Publishing Companion* is a book about publishing rather than computers. This is certainly true and he writes as much about the general publishing process as he does about desk-top publishing (DTP) in particular.

The author does tackle problems such as what hardware to buy and how to go about choosing a DTP package. However, he takes the wise line that just as no word-processing program will make an illiterate into a Shakespeare, neither will a DTP program make a novice into a Harold Evans. He feels that anyone using a DTP package will have to learn as much about designing, planning and distributing their document as about how to use a particular program.

The book discusses the pros and cons of different machines and packages, giving synopses of how different packages work and what

purposes they are best suited for. He even advises that you may want to use not just one package but a few, exploiting the advantages of each. He also writes about what ancillary equipment you might need, such as laser printers, image scanners and so on.

Much of the book is given over to tips on how to lay out pages — complete with sample layouts to follow — positioning graphics, use of typography and the like. It also gives basic guidelines on writing and the finer points of production, such as where to hyphenate words and how to write headlines. It even looks at the legal aspects of publishing, giving advice on copyright and libel. To finish, there is a helpful chapter of source material which gives addresses of distributors, companies running training courses and publishers of relevant magazines.

This is an extremely useful book: not only does it look at the computing side of DTP, it also makes readers aware of the world of publishing beyond the bounds of the PC or Mac on their desk. Anyone producing anything using a DTP system — from a newsletter to a book or brochure — should find it worth reading. **CH**

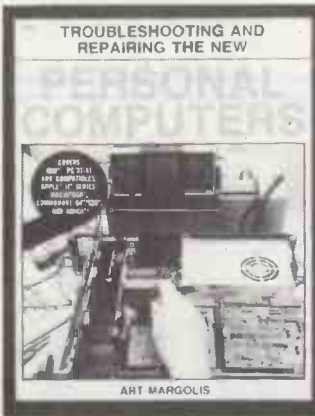

MAINTENANCE

TROUBLESHOOTING AND REPAIRING THE NEW PERSONAL COMPUTERS

By Art Margolis • Published by John Wiley and Sons, £18.05 • ISBN 0 8306 2809 6

THERE is an apocryphal story that went the rounds a few years ago about a man who decided to make his home computer go faster by removing the transformer and attaching the mains directly to the circuit board. The moral of the story was that a little knowledge is a dangerous thing.

Art Margolis's *Troubleshooting and Repairing the New Personal Computers* seems to be providing the reckless amateur with the little

BOOK

REVIEWS

knowledge required to wreck a PC. He explains how to adjust the speed of your disc drive, attach all kinds of gizmos to chips, and desolder surface-mount devices. The consequences of mistakes hardly need to be spelt out.

This is not to say that the book is without merit. It gives detailed explanations at the transistor level, of how processors, RAM, ROM and support chips work. It is worth reading by anyone interested in how their computer works at the electronic level, although many of the early pages contain very basic information.

Although published this year and claiming to take in the Macintosh, IBM PC and Amiga micros. It is obvious that the book is a rewrite of one that Margolis wrote some years ago, as there are frequent references to the TRS-80 and Vic-20 computers. All the same, it is a worthwhile read, as long as you hide the soldering iron before you start. **SM**

PCs FOR BEGINNERS

USING MICRO COMPUTERS: APPLICATIONS FOR BUSINESS

By J Wayne Spence and John C Windsor • Published by Blackwell Scientific Publications, £23.50 • ISBN 0 8016 4778 9

SAD to say, *Using Micro Computers* proved to be a disappointment, mainly because of the tone the authors adopt to explain things. It claims to be a practical introduction to using a micro as a business problem-solving tool. The problem is that the book appears to be aimed at students and sixth-formers, and many of its examples are geared to such a readership.

The authors follow the trials of a fictitious character called Chris Thompson who has just started a new job. Each chapter is preceded by a scenario which details in Raymond Chandler fashion what is happening in Chris's job. He meets various friendly employees

(continued on next page)

BOOK

REVIEWS

(continued from previous page) who offer to show him their spreadsheet and recommend courses in computing for him to go on. By being super-keen and managing to solve every problem he comes across using a micro, Chris rises through the company without finding any bodies in the elevator on the way. The book ends with Chris being promised promotion to another part of the company.

If you can tolerate the American flavour of the book and reading about creepy Chris, it might be worth a look. It contains many illustrations and colour photographs, and there are detailed explanations of subjects ranging from operating systems to communications. The authors introduce many of the popular

packages, including WordStar, Lotus 1-2-3, dBase II and III, and the PFS products. Also the idea of setting a business-orientated problem which has to be solved by using a particular application is a good one. But whether busy people can spend their time wading through the 678-page book to sift out the relevant information is another question. *CH*

THE INFORMATION AGE

THE CULT OF INFORMATION—THE FOLKLORE OF COMPUTERS AND THE TRUE ART OF THINKING

By Theodore Roszak • Published by Lutterworth Press, £12.95 • ISBN 0 7188 2674 4

THE premise of this book is probably misconceived, but it still makes a good read. Roszak takes as his theme the idea that powerful vested interests are encouraging people to confuse the way computers and human beings think; the computer is being held up as an accurate model of the human mind. According to Roszak, this devalues and puts at risk precisely those powers of reason and imagination which make us superior to machines.

What he has really got it in for is the term "information", as in "the information society", "information technology" and so on. He thinks these phrases are often deliberately used to conceal the real nature of the changes that are going on. Roszak is also worried about the corrupting effects of the school micro on the nation's youth.

It seems to me that the main weakness of Roszak's argument is that the more contact people have with computers, the less tendency they have to venerate them. They rapidly appreciate that the machines are basically very simple-minded and that the cleverness resides in the human-written software. The fascination of computers to anyone who gets seriously involved with them is that at a deep level they are so obviously creations of the human mind.

But the book is well worth reading for the observations and — I hate to say it — the information it imparts along the way. Roszak is a professor of history, and in developing his argument he lays out a very good informal history of the evolution of the computer industry.

He describes Shannon's pioneering work on information

theory, the rise of IBM-style corporate computing and the counter culture of micro users. None of these things impresses him much, but he really gets into his critical stride with the development of the notion of artificial intelligence and the educational ideas of people like Seymour Papert.

Sometimes the book rings true, as when it describes the way politicians and corporations have increasingly resorted to the tactic of swamping the citizenry with more raw data and supposed facts than they can possibly absorb. Very often this successfully confuses and conceals the real issues, allowing those in control to retain the initiative.

But most of the time I feel Roszak is getting worried about an antique notion of computing — big centralised machines which work with masses of data and require everybody to adapt to their way of doing things. This is data processing 1950s-style. True, a lot of it still goes on, but hopefully the arrival of cheap, small computers and the idea of the personal-productivity tool has decisively shifted things in another direction. *IS*

Reviewers this month: Carol Hammond, Steve Malone, Ian Stobie.

DAMSON COMPUTING DAMSON COMPUTING DAMSON-SANYO SUPPLIER. ASK SANYO RANGE

SANYO IBM PC COMPATIBLE RANGE
Following include 6W basic ver 3.2 & MS DOS 3.2.
Ser & Par Ports, 3 slots (1 reserved), on site
MBC 16 PLUS1, 1 x 360K 5.25" DRIVE, 256K RAM
£495
MBC 16 PLUS 2, 2 x 360K 5.25" DRIVES,
540K & MONITOR..... £729
MBC 16 PLUS3, 1 x 360K + 20MB DRIVE + CONTR
£975
MBC 16 PLUS 3, 1 x 360K + 20 MB
DRIVE + MONITOR..... £930
PR 5200 DAISY WHEEL PRINTER, 20CPS..... £249
PR 241 24-PIN FULL SIZE DOT MATRIX PRINTER
..... £470

EPOA
SANYO MBC 885 (IBM COMPATIBLE)..... £325
20 MB PC UPGRADE..... £395
30 MB PC UPGRADE (Non Compatible)
Sanyo MBC 555 (Non Compatible)
2 + 160 + WS + CS + DS +

Following packages include WS, IS, CS.
Sanyo MBC 5552, 2 + 160K Di/Drives, 128K RAM
..... £295
Sanyo MBC 555-2, 2 + 360K, VER2.11, 128K RAM
..... £295

Sanyo MBC 555 2x800K DRVS, VER2.11, 256K
RAM..... £495
Sanyo MBC 555 2 x 800K DRVS, 256K, Monitor,
Printer with WS/IS/CS & Basic..... £695

Sanyo DM4112 12" Mono Monitor..... £85
Sanyo Memory Upgrade to 256K..... £45
Sanyo disk drive upgrade 2 + 800KB..... £245

AMSTRAD PC RANGE

AMSTRAD IBM Compatible Machines
(WARNING: ON SITE MAINTENANCE CONTRACT
STRONGLY RECOMMENDED ON ALL AMSTRAD
SYSTEMS)

PC 1512 SD M..... £432
PC 1512 DD M..... £495
PC 1512 SD COLOUR..... £619
PC 1512 DD COLOUR..... £729
PC 1512 SD + 20MB M..... £899
PC 1512 DD + 20MB COLOUR..... £1069

BONDWELL BUDGET SERIES

BW34 + 105 12"MM & 204 MULTI-FUNCTION
CARD..... £569
BW36 + 105 12"MM & 204 MULTI-FUNCTION
CARD..... £549

PROFESSIONAL SERIES

BW38-2 + 105 12"MM & 210 MONOCHROME
CARD..... £759
BW38-3 INC 105 12" 210 MONOCHROME CARD
..... £999
BW63 full size 512KB AT..... £1699
BW39 small footprint 1MB AT..... £1799

PORTABLE SERIES

BW16 TRANSPORTABLE..... £629
BW8 PORTABLE..... £699

DAMON FOR BONDWELL 8

BW112B or BW113..... £170
BONDWELL ACCESSORIES..... EPOA

MONITORS

BW 105 GREEN..... £84

BW105A AMBER..... £94
BW105C HIGH RES..... £284

EXPANSION CARDS

BW 210..... £46
DAMSON COMPUTING DAMSON COMPUTING
THE SBC FD (FREE ON SITE MAINTENANCE
CONTRACT) CLAIMED TO BE THE BEST VALUE
PC IN EUROPE TODAY
SBC FD Twin Drive 360K with Mono Monitor..... £599
SBC HD20 as FD but with 20MB Hard Disk..... £999
Add £200 above for Colour Monitor

THE BRITISH DESIGN & BUILT SBC Mistral 286AT.

80286 CPU at 6.8 or 12 MHz, 1MB on board (max.
4MB)
1.2MB Floppy Drive, 30MB Hard Dis, battery
backup
6 Expansion Slots, 80287 Math Co-Processor
socket Motherboard built in the UK by Baa, 14"
Grinamber MS DOS 3.2 GW-BASIC 3.2, 1 Year on-
site maintain.

84 key AT Keyboard..... £1799
20 MB PC UPGRADE..... £325
30 MB PC UPGRADE..... £395

PRINTERS

DOT MATRIX (Special Offers)
CANON LBP8A1 8PAGEMINI/A4..... £1795
CANON A2 LASER..... £2630
CANON PW 1000A NLO..... £252
CANON ASO 180 CPS/NLO/80CDL..... £275
CITIZEN 1200 120CPS/80COL..... £159
CITIZEN LS 100 120CPS/80COL..... £199
EPSON FX800 160 CPS/NLO/80COL..... £310
EPSON FX1000 160 CPS/NLO/132COL..... £410
EPSON LX86 120 CPS/NLO/80COL..... £199
EPSON LQ800 180CPS/NLO/80COL..... £445
EPSON LQ1000 180CPS/NLO/132COL..... £576
EPSON EX800 300CPS/NLO/132COL..... £395
EPSON EX1000 300CPS/NLO/80COL..... EPOA
JUKI 5510 80CPS/NLO/80COL..... £245
JUKI 5520 180CPS/NLO/80COL/COLOUR..... £340

AMSTRAD DMP200NLO..... £139
AMSTRAD DMP 3000 NLO IBM..... £169
Brother M1105 FIT PIS (New) NLO..... £189
EPSON FX800..... £310
EPSON FX1000..... £410
EPSON LX86 120 cps NLO..... £205
EPSON LQ800..... £449
CANON ASO 180cps (NLO)..... £275
CANON PRINTER/COMPUTER RANGE..... EPOA
CITIZEN 1200 IBM/EPSON/IFT NLO..... £159
PANASONIC 1081..... £159
MP 135 120 cps, 80 column F/T..... £159
MP 165 165 cps, 80 column F/T..... £199
MP 201 200 cps, 132 column F/T..... £299

DAISY WHEEL (Special Offers)

JUKI 6100 Bid (10 Period)..... £269
JUKI 2200 Typewriter/printer..... £216
Sanyo PR5200 20cps reviewed-What/Micro, May 87
..... £249

MP-DAISYWHEEL RANGE

Sanyo disk drive upgrade 2 + 800KB..... £245
20 MB PC UPGRADE..... £325
30 MB PC UPGRADE..... £395
WS 4000 MODEM V21, V23, V22 OPTIONAL..... £144

Tailor made
FOR THE SERIOUS MICRO USER

CUT ON THE BUSINESS BIAS

£2000

FOR MORE INFORMATION PLEASE CONTACT
NEIL MARCHANT ON 01-661-3021

Please contact DAMSON for competitive prices on ribbons. Please do ask for the best possible price at any time. Please add £9.00 + VAT per heavy item for parcel post (UK) delivery and £2.00 + VAT per item for ribbon and disk boxes. DAMSON COMPUTING advise, supply, install, maintain complete systems tailor made to customer specifications. All prices exclude VAT, are rounded to the nearest pound and are subject to change without notice. Export and quantity enquiries welcome. DAMSON COMPUTING (MAIL ORDER), 6 RAYS ROAD, EDMONTON, LONDON N18 2NX. (CALLERS BY APPOINTMENT). EASY TO REMEMBER ADDRESS, P.O. BOX 100, LONDON N18, U.K. TELEPHONE: 01-803 7074 and 01-807 7577. TELEX 8950511 ONEONE G, PLEASE QUOTE TELEX BOX NO. 14514001.

→ circle 160 on enquiry card ←

FILE-SIZE TOTALS

If you regularly back up your hard disc on to floppies this program by **Jim Bates** will help you ensure that you make economical use of your disc space.

THERE are times when you wish to copy a number of files across from a hard disc to floppy discs, usually for archiving or storage purposes but also for transfer to other machines. A crude way to tell how many discs will be required is to total the sizes of all the relevant files and then divide by the capacity of a floppy disc. Even then, the answer you get may not be accurate because files usually take up more room on a disc than their stated size in the directory listing. The utility listed this month provides a more convenient method of doing the same job.

TD.Com is non-resident and works in a similar fashion to the Dir command. You use it from the DOS prompt. Entering TD followed by a file specification produces a wide listing of all file names that match the specification. Thus, entering

TD*DAT

gives a listing of all the Dat files. The program also shows the total amount of space that the files would occupy if transferred to floppy discs, and the number of discs that this total would represent. TD.Com makes no correction for large quantities of small files — see box below — but does correct for file allocation size.

TD.Com uses a similar procedure to the Prompted Delete program discussed last month, in that file names which match the command tail are found and

```
A:\>td *.*
BATES Associates - File Size Totaller Version 1.30
Selected Files are :-
TD      .COM  TD      .DAT  TD      .ASM  ARTICLE .TXT  OPTIM   .COM
OPTIM   .DOC

These 6 files occupy a total of 55296 Bytes
and would require at least 0.15 Floppy Disk(s)

A:\>
```

TD displays a directory listing followed by the total size of the files.

displayed on the screen. Another function reads the file size from the directory entry and then applies an arithmetic calculation to decide how much space this file would occupy when transferred to a floppy disc.

The layout of the assembler

listing follows the scheme I have used in previous months, with the exception that I have moved the data area to the end of the listing. This cuts down the amount of typing needed when using the Basic Loader to enter the program since there is now no need to enter

the 73 zeros which represent the buffers used by the program.

The first section sets up the equates to identify the CR and LF characters and the command tail address (CMD). I have also added a definition of one of the most often used interrupt functions as

DISPLAY EQU 200H

because this makes the assembly-language program easier to read. With the origin (Org) set at 100Hex — which is mandatory for Com files — the first instruction is to jump over the message area to label Start.

The message area is self explanatory, and you will see how the equates of CR and LF make it easy to find where a line ends in a particular message. One point of interest is in MSG01, where I wanted to display the word "Can't." The problem here is that the assembler uses the single apostrophe to indicate the start and finish of a text string. It was therefore necessary to put the apostrophe in as character number 39 and then continue the message afterwards.

The strings of zeros in the messages Fil_Tot and Asc_Tot are actually replaced by the program with the results of calculation. The characters used are therefore immaterial, but I find that zeros are convenient and are much easier to count when deciding what the screen output from

(continued on next page)

HOW DATA IS STORED ON A FLOPPY

The standard floppy disc on an IBM PC is double-sided with 40 concentric circular tracks of recorded data on each side. Each track is divided into nine equal sections, called sectors. Thus each disc has 360 sectors per side or 720 sectors altogether. Each sector contains 512 bytes of data, so the total capacity of a floppy disc is 368,640 bytes.

Not all of this space is available for data storage. When a floppy disc is formatted for use under MS-DOS, certain pre-specified areas are set aside for special purposes. The very first sector on track zero of side zero is used to indicate to the computer what type of disc it is dealing with. It contains details of the type of system that the disc should operate with — MS-DOS in this case — whether the disc has an operating system on it, and so on.

The next four sectors contain the File Allocation Table (FAT), which is a sort of street map of available space on the disc. The FAT is used by the operating system to decide where to put data when new files are added. The next seven sectors are the directory sectors, and they contain an index of the names of all the files on the disc together with details of the size and location, and the date and time that each file was last updated. The remainder of the disc is available for data storage, though if the disc has been formatted with the /S option several sectors will contain the relevant system files. Thus, of the original 720 sectors only 708 are available for data storage. Multiplying this by 512, will give you the familiar figure of 362,496 bytes which you see whenever Chkdsk is run on a floppy.

MS-DOS allocates space on a disc in blocks called clusters or allocation units. On IBM PC floppies the cluster size is two

sectors or 1,024 bytes. This means that when a file is copied on to a floppy disc it will occupy a number of clusters large enough to contain the file.

You can see this for yourself by doing a simple experiment. First format a floppy disc — without the system files — and then run Chkdsk to ensure that you do have 362,496 bytes available. Now copy any file smaller than 1,024 bytes on to the floppy, and type Dir to produce a directory listing. You should see your small file name listed and the available bytes shown as 361,472, or 1,024 bytes less than you had before.

This seems to indicate that with 354 clusters available on the disc, copying 354 files of one byte each would fill the disc, since each file would occupy one cluster. However, there is a further complication, since each file name along with its associated data will occupy 32 bytes in a directory sector. Although the disc can store 354 separate clusters, the seven directory sectors can only hold 3,584 bytes or 112 file name entries. One of these entries would be the volume name of the disc if the /V option was used during formatting. The net result is that if you have more than 111 files to copy, and they are all less than three clusters in size, you will fill the directory before you fill the disc.

This limitation on the number of directory entries is not considered serious on floppy discs, but it can be a nuisance when dealing with large numbers of small files. One way around it is to create a sub-directory on the disc and copy files into that. A sub-directory is actually a file laid out in exactly the same way as the directory sectors. The difference is that it is not limited in length in the same way as the directory, so up to the limit of disc capacity you can list as many file names as you wish.

UTILITIES

TD.ASM ASSEMBLER LISTING

```

COMMENT *
This program is designed to produce a byte total of the sizes
of all specified files, corrected for allocation units.
*
;=====
; EQUATES
;=====
CR EQU 13 ; Carriage Return character
LF EQU 10 ; Line Feed Character
CMD EQU 81H ; Name Command Line Buffer
DISPLAY EQU 200H ; Name DISPLAY Function
; (to display contents of DL)
;=====
CODE SEGMENT
MAIN PROC FAR
ASSUME CS:CODE, DS:CODE, ES:CODE
ORG 100H ; MUST BE 100H FOR .COM FILE
BEGIN: JMP START
;=====
; PRIMARY DATA AREA
;=====
; MESSAGES
MSG00 DB 'BATES Associates - '
DB 'File Size Totaller Version 1.30'
MSG01 DB CR,LF,'Selected Files are :-',CR,LF,CR,LF,'$'
DB 'Can',99,'t total just one file!'
CRLF DB CR,LF,'$'
NF_MSG DB 'No Matching Files Found!',CR,LF,'$'
TOT_MSG DB CR,LF,CR,LF
DB 'These '
FIL_TOT DB '0000 files occupy a total of '
ASC_TOT DB '0000000 Bytes',CR,LF ; ASCII Total
DB 'and would require at least '
FLOPTOT DB ' Floppy Disk(s)',CR,LF,CR,LF,'$'
;=====
; END OF PRIMARY DATA AREA
;=====
; CODE AREA
;=====
; Main Code starts here -
START:
LEA DX,MSG00
MOV AX,900H
INT 21H ; Display Sign on message
MOV SI,OFFSET CMD ; Source to Command Line
MOV DI,OFFSET FCB ; Set Destination to
; point to File Control Block
MOV AX,2900H ; Function Call 29H
INT 21H ; Parse Command Line to FCB
CMP AL,1 ; * or ? in filename?
JNZ ERROR1 ; No - can't total one file
CALL GET_FILES ; Read matching directory entries
CMP AL,1 ; Did we find any?
JNZ ST2 ; Yes - so jump
LEA DX,NF_MSG ; No files found
JMP QUIT

ST2:
CALL SHOW_SIZE ; Total and HEX to ASC Conversion
CALL DIVIDE ; How many Floppies?
LEA DX,TOT_MSG ; Completed message

QUIT:
MOV AH,9 ; Display it
INT 21H
MOV DX,OLD_DTA ; Restore original DTA
MOV DS,OLD_DTA+2
MOV AH,1AH
INT 21H
MOV AX,4C00H ; Termination code
INT 21H ; Terminate Program

ERROR1:
LEA DX,MSG01 ; Only one file!
MOV AH,9 ; Display it
INT 21H
MOV AX,4C01H ; Termination code with Error
INT 21H ; Terminate Program

MAIN ENDP ; End of Main Program Code
;=====
SUBROUTINES
;=====
SBRGS PROC NEAR
GET_FILES:
PUSH CS
MOV AH,2FH ; Get current DTA
INT 21H ; Save ES:BX in OLD_DTA
MOV WORD PTR OLD_DTA,BX
MOV WORD PTR OLD_DTA+2,ES
POP ES ; Restore ES from stack
MOV DX,OFFSET DTA ; Tell DOS where New DTA is!
MOV AH,1AH
INT 21H
MOV DX,OFFSET FCB ; Start Search using FCB pattern
MOV AH,11H ; Get First Entry
INT 21H
CMP AL,0H ; Found one?
JZ GET_NEXT ; Process found filename
MOV AL,01 ; Set to indicate No Files Found
RET ; Look no more

GET_NEXT0:
MOV DX,OFFSET FCB ; Next Search
MOV AH,12H ; Get Next Entry
INT 21H

GET_NEXT:
OR AL,AL ; Check if found
JNZ NO_MORE ; Not found - no more files
CALL ADD_SIZE ; Add filesize to total
CALL SHOW_NAME ; Put found filename on screen
JMP GET_NEXT0 ; Go again

NO_MORE:
MOV AL,0 ; Set return code to No Error
RET ; Finished finding files
;=====
ADD_SIZE:
MOV DI,OFFSET FSIZE ; Get Lo Word of file size
MOV AX,[CLUSTER] ; Cluster size into AX
DEC AX ; Less one for correction
ADD [DI],AX ; Add them (maybe carry)
MOV AX,0 ; Zero AX
ADC [DI+2],AX ; Add carry into HI Word
MOV DX,[DI+2] ; Prepare to divide
MOV AX,[DI]
MOV CX,[CLUSTER] ; by cluster size
DIV CX ; AX now has number of clusters
MUL CX ; DX:AX has corrected size
MOV BX,[TOTALW1] ; Get lower word of total so far
ADD BX,AX ; Add file size to total
MOV [TOTALW1],BX ; put it back into memory
MOV BX,[TOTALW2] ; Get higher word of total so far
ADD BX,DX ; Add file size to total with
; carry from previous addition
MOV [TOTALW2],BX ; put it back into memory
MOV BX,OFFSET FILES ; Get File counter
INC WORD PTR [BX] ; add one to it
; finished adding this file
;=====
SHOW_NAME:
INC [FCOUNT] ; Count of names displayed
MOV SI,OFFSET DTA ; Get pointer to transfer area
MOV CX,8 ; going to show first 8 bytes

SN0:
INC SI ; point to next byte
MOV DL,[SI] ; get the character
MOV AX,DISPLAY ; display it
INT 21H
LOOP SN0 ; do it again (8 times)
MOV DL, ; now display a full stop
MOV AX,DISPLAY ; display it
INT 21H
MOV CX,3 ; Prepare to show next 3 bytes

SN1:
INC SI ; point to next byte
MOV DL,[SI] ; get the character
MOV AX,DISPLAY ; display it
INT 21H
LOOP SN1 ; do it again (3 times)

MOV CX,3 ; Prepare to show 3 spaces
MOV DL,20H ; Load a space character

SN2:
MOV AX,DISPLAY ; display them
INT 21H
LOOP SN2 ; go again (3 times)

```

(continued from previous page)

a program should look like. On the other hand, the eight blanks at the start of the Floptot message are not replaced; the relevant numbers are simply inserted as calculations are completed.

The first part of the code after the message area at Start begins by displaying the sign-on message (MSG00). The program then uses a new function call into interrupt 21hex. This is function 29hex, which will sort out a file name into a form that other DOS functions

can use. Various options are available with function 29hex, but the only one of interest here builds a file name from a string containing the global characters * and ?.

Function 29hex is used to build a complete file specification from the string addressed by DS:SI into the area addressed by ES:DI. In a Com program, all segment registers are set to the current code segment and so can be ignored. SI is set to point to CMD, and DI points to the File Control Block (FCB). Function 29hex will return

a code in register AL to indicate the result of the interrupt. The result 01 indicates that global characters were used in the command line, and so a check is made to see if it is present; if it is not, the program must abort with an appropriate error message. This is done by the JNZ Error1 instruction, which will display the message MSG01 before terminating execution and returning to DOS.

Assuming that a correct command tail was entered, the routine Get_Files is called. If it returns

with 01 in AL, then no matching files were found and the program displays an appropriate message and terminates. Get Files is very similar to the routine used in the Prompted Delete program, except that in this instance I decided to set up a special buffer called the Disc Transfer Area (DTA) for accessing the data recovered from the disc directory.

The first part of Get_Files uses function 2Fhex to collect and store the existing DTA into the four bytes at label Old_Dta. This

- UTILITIES -

TD.ASM ASSEMBLER LISTING

```

MOV     AL,5           ; Check FCOUNT to see if we've
CMP     AL,[FCOUNT]   ; displayed 5 names.
JZ      SN3           ; if we have, then jump.
MOV     AX,DISPLAY    ; Otherwise display one space
INT     21H           ; and return.
RET

SN3:
MOV     DL,CR         ; We've shown five names so
MOV     AX,DISPLAY    ; now send a carriage return.
INT     21H
MOV     DL,LF         ; and a line feed
MOV     AX,DISPLAY
INT     21H
XOR     AX,AX         ; Now we must reset FCOUNT to 0
MOV     [FCOUNT],AL
RET

;=====
SHOW_SIZE:
MOV     AX,[TOTALW1] ; Get low word of total
MOV     DX,[TOTALW2] ; Get high word of total
MOV     DI,OFFSET ASC_TOT ; Point to TOTAL section
CALL    AXHEX2ASC    ; of message
CALL    FILNUM       ; Convert to ASCII and
RET                ; shove it into message
                ; Do the same for the
                ; number of files found.

AXHEX2ASC:
PUSH    DI           ; Save the destination pointer
DIV     [DIVISOR1]   ; Divide DX:AX by 10,000
PUSH    DX           ; Save first remainder
MOV     SI,OFFSET DIVISOR2 ; Point to DIVISOR2
XOR     DX,DX        ; Clear DX
DIV     WORD PTR [SI] ; Divide DX:AX by 1,000
OR      AL,30H       ; Make the answer ASCII
STOSB   ; Send to Destination
ADD     SI,2         ; Point to DIVISOR3
MOV     AX,DX        ; Get second remainder
XOR     DX,DX        ; Clear DX
DIV     WORD PTR [SI] ; Divide DX:AX by 100
OR      AL,30H       ; Make the answer ASCII
STOSB   ; send to Destination
MOV     AX,DX        ; Get third remainder
AAM     ; Adjust for ASCII conversion
OR      AX,3030H     ; Make the answer ASCII
XCHG   AH,AL        ; Swap the two digits around
STOSW   ; Send to Destination
POP     DX           ; Restore first remainder
MOV     CX,3         ; Going to divide three times
MOV     SI,OFFSET DIVISOR2 ; Point to DIVISOR2
CALL    HEXLOOP1
; Routine to suppress leading zeroes in total number

MOV     CX,7         ; Going to check 7 positions
POP     DI           ; Restore original destination
; (start of ASCII number)
MOV     AL,20H      ; Load a space character into AL
HEXLOOP2:
CMP     BYTE PTR [DI],30H ; Is character a zero?
JNZ    HEXEND       ; NO! so quit
STOSB   ; Yes, so replace with a space
LOOP   HEXLOOP2     ; Go again (until first
; significant digit is found)
HEXEND:
RET                ; Finished conversion

HEXLOOP1:
MOV     AX,DX        ; Get remainder into AX
XOR     DX,DX        ; Clear DX
DIV     WORD PTR [SI] ; Divide DX:AX by DIVISOR?
OR      AL,30H       ; Make the answer ASCII
STOSB   ; Send to destination
ADD     SI,2         ; Bump DIVISOR pointer
LOOP   HEXLOOP1     ; Go again (3 times)
OR      DL,30H       ; Make DL into ASCII
MOV     AL,DL        ; Put it into AL
STOSB   ; Send it to Destination
RET

;=====
FILNUM:
MOV     DI,OFFSET FIL_TOT ; Number of files message
MOV     DX,WORD PTR [FILES] ; Get total in to DX
FILNUM0:
PUSH    DI           ; Save destination
MOV     CX,3         ; Going to divide 3 times
MOV     SI,OFFSET DIVISOR2 ; 1,000 decimal
CALL    HEXLOOP1
MOV     CX,3         ; Going to check up to 3 times

XCHG   DI,DX        ; Get current position into DX
POP     DI           ; Restore destination
MOV     AL,20H      ; Load space character into AL
JMP    HEXLOOP2     ; Go suppress zeroes

;=====
DIVIDE:
MOV     DX,[TOTALW2] ; Get High Word of total
MOV     AX,[TOTALW1] ; Get Low Word of total
MOV     SI,OFFSET FLOPPY ; Point to DIVISOR
DIV     WORD PTR [SI] ; Divide!
MOV     DI,OFFSET FLOTTOT ; Point to Destination
PUSH    DX           ; Save remainder
PUSH    AX           ; Save part quotient
XOR     DX,DX        ; Clear DX
MOV     DL,AH        ; Put Quotient into DL
CALL    FILNUM0     ; Convert and store it
MOV     DI,DX        ; Restore dest'n pointer
MOV     AL,'.'       ; Decimal point character
STOSB   ; Send it
POP     AX           ; Restore part quotient
XOR     DX,DX        ; Clear DX
MOV     AH,0         ; Multiply just AL
MUL    WORD PTR [SI] ; Cancel previous div'n
POP     BX           ; Restore remainder
ADD     AX,BX        ; Add it in
ADC     DX,0         ; Add any carry to DX
DIV     [FL100]      ; Now calculate to
AAM     ; 2 decimal places
OR      AX,3030H     ; ASCII Adjust
XCHG   AH,AL        ; Convert AX to ASCII
STOSW   ; Get them in reverse
RET                ; order for sending
; Finished calculation

;=====
SECONDARY DATA AREA
;=====
; Data Area - where numeric constants are stored
DIVISOR1: DW 10000 ;= 10,000 Decimal
DIVISOR2: DW 1000 ;= 1,000 Decimal
DIVISOR3: DW 100 ;= 100 Decimal
DIVISOR4: DW 10 ;= 10 Decimal
FLOPPY: DW 0588H ; 1/256th of a Floppy
FL100: DW 0E20H ; 1/100th of a Floppy
CLUSTER DW 1024 ; Size of a Floppy Cluster
; NB: A Hard disk cluster is 2048 bytes
OLD_DTA DD 0 ; Old DTA Address
; File Search Block - Contains file spec for matching
FCB DB 33 DUP (0) ; Search File Control Block
; DTA - This is where found files appear,
; together with the relevant details on file size etc.
DTA DB 29 DUP (0) ; Disk Transfer Address
FSIZE DB 4 DUP (0) ; File Size Double Word
; Calculation Area - where numeric variables are stored.
TOTALW1 DW 0 ; Byte Total Word 1
TOTALW2 DW 0 ; Byte Total Word 2
FILES DW 0 ; Number of Files
FCOUNT DW 0 ; Count of Filenames displayed
;=====
END OF SECONDARY DATA AREA
;=====
SBRS ENDP ; End of Process
CODE ENDS ; End of Segment
END BEGIN ; End of program and Start Address

```

should be address 80hex in the program's own code segment, but since you can never be quite certain of anything in writing assembly language, it is collected and saved for restoration later. The DTA can now be set up by putting the address into DX — actually DS:DX — and calling function 1Ahex to set it.

Now the program is ready to start looking for files. It searches for the first one by using function 11hex as last month, and checking for zero in AL. If a file is not

found, AL is marked with a 01 and the program returns from the Get_Files subroutine. If the first file was found, you can branch ahead to Get_Next where the Add_Size and Show_Name routines are called.

Processing then returns to Get_Nexto, this time using function 12hex to find the next matching file name. The program will continue executing around this loop until AL returns with something other than zero after function 12hex is called. When this

eventually happens, 00 is put into AL to show that files were found, and the program returns to the main program code.

As each file name is found, the details regarding that file are read from the disc into the DTA. You will see in the Secondary Data Area at the bottom of the listing that the DTA is set up in two sections. The first part is 29 bytes long, and the next four bytes are labelled FSize. Thus when the file details are transferred into this area the file-size bytes can be accessed im-

mediately since they have already been labelled.

The first routine that is called when a file has been found is the Add_Size routine. This routine must calculate the number of clusters required to store any particular file. The arithmetic necessary to accomplish this is quite simple. The program first adds a complete cluster, less one byte, to the file size, then divides by the cluster size. This produces a number representing the total

(continued on next page)

(continued from previous page)

number of clusters required, plus a remainder which represents a number of bytes. The remainder can be ignored since a full cluster — less one byte — was added to start with. The number you are left with represents the number of clusters required to contain the file. The final step is to re-multiply the number of clusters by the cluster size, giving the exact number of bytes in the specified number of clusters.

The coding for this calculation is at the start of the Add_Size routine. The DI register is first set to point to the file-size bytes in the DTA, and the cluster size is collected into the AX register. I have deliberately set the cluster size into a data area so that more enterprising users can modify it for other values.

Having collected the cluster size, the program decrements it and adds it to the low word of the file size. This addition may cause a carry, which must be added to the high word of the file size, so AX is cleared and then added — with carry — to the high word. It is now necessary to divide, so the high word of the file size is put into DX and the low word into AX; for the divide instruction, DX:AX represents a 32-bit integer value. The divisor — which is the cluster size — is placed into CX, and a Div instruction is issued. This leaves the quotient — equal to the number of clusters — in AX, and the remainder in DX. For the multiplication, AX is considered as a single 16-bit value so DX can be ignored. A MUL instruction puts the product into DX:AX; again as a 32-bit integer value.

ADD VALUES

All that remains is to add this value to the total of files found so far. I have coded the addition slightly differently this time, just to illustrate that there are different ways of doing the same thing. The low word of the total — which is in TotalW1 — is placed in BX, and the low word of the correct file size, AX, is added to it. This may result in a carry. The result is then replaced in TotalW1. TotalW2 is taken in the same way, and DX is added to it, this time with whatever carry may have resulted earlier. TotalW2 is then also replaced. The final step in the Add_Size routine is to add 1 to the value of Files.

The next task is to display the file name on the screen. DTA has the full name of the file that has just been found and totalled, so this can be used for the display. The layout of the file name is slightly different to the normal

TD.COM DATA FOR BASIC LOADER

Table with columns for Line, Displacement, and Hex/Decimal values. It lists 73 lines of assembly-like data.

arrangement. Instead of the familiar Name.Ext construction, the DTA will always contain 11 characters. The first eight are the file name, padded out with spaces if necessary, and the remaining three are the extension, again padded with spaces.

There are many ways to reinterpret this format, but I decided that to keep the code simple I would just add a single full stop between the eighth and ninth characters of the file specification. This splits the name from the extension, leaving the spaces in place. I also decided that the simplest display would be five columns of file names along each line of the screen, rather like the format of the Dir/W listing. This means keeping a count of how many files have been displayed on the current line, and issuing a Carriage Return and a Linefeed when five have been shown.

This is all done in the Show_Name routine. First the program increments the displayed file count (FCount). Then it points

to the SI register at the start of the DTA and uses the CX register to set up a loop count of 8, for the first eight characters. In this first loop at SNO, SI is incremented to point to the required character, move it into the DL register and call the Display function. You can now see how equating the word "display" to function 2 makes the program easier to read.

NAME DISPLAY

Processing continues looping until the CX count is exhausted, thus displaying the first eight characters in the file name. The full-stop character is then put into DL and displayed. The loop routine is repeated at SN1, this time for the three characters of the extension to the file name. Three spaces are then needed to position the cursor ready for the next file name. Finally a check is made to see if five file names have been displayed on this line. If they have not, the routine is exited; otherwise it displays a Carriage Return and a Linefeed to move the cursor

down to the beginning of the next line, and the value in FCount is reset to zero.

The Get_Files routine continues finding, totalling and displaying until there are no more files. Assuming that files were found, processing continues at ST2 in the main code. At this point, the corrected total of the sizes of all files found have been accumulated in TotalW1 and TotalW2, while the total number of files involved is held in Files.

These answers along with the relevant messages must now be displayed on the screen. The first process is to call the Show_Size routine. It starts by loading the file size in 32-bit binary form into DX:AX and the destination pointer for the ASCII answer into DI. The program can then call the Ahex2Asc routine. The arithmetic in this routine takes the 32-bit number in DX:AX and converts it into ASCII characters representing the decimal equivalent of the number. The Ahex2Asc routine can in fact be used whenever binary to decimal/ASCII conversion is required.

REPEATED DIVISION

Though the maximum number that can be stored in 32 binary bits is something in excess of 4,000 million, the largest number you are likely to encounter when dealing with file sizes is around 20 million. The decimal number 13,742,568 represents one 10-million, plus three million, plus seven hundred-thousands, plus four 10-thousands and so on. So by taking the file-size total and dividing it by 10 million you get a quotient that corresponds to the first decimal digit; similarly, dividing the remainder by one million, the quotient becomes the second decimal digit. By repeating this process and dividing the remainders by reducing powers of 10 each time you eventually get all the decimal digits. The only snag with this is that the 8086 processor only allows a maximum divisor of 16 bits or 65,535 decimal. This makes it necessary to divide twice on the initial step — first by 10,000 and then by 1,000, making 10,000,000 in all.

The program enters the Ahex2Asc routine with the required number in DX:AX and the destination pointer for the answer in DI. First it saves the DI pointer on the stack, and then it completes the division by 10,000. The remainder, DX, is saved on the stack, and the program performs a further division by 1,000. AX now has the number of 10-millions; since it will always be less than 15 only the low-byte AL

portion will be of interest. It is converted to an ASCII code by the OR AL,30H instruction and then sent to the destination using Stosb.

The remainder from the second division, which is still in DX, is moved into AX and DX is cleared to zero. SI is then pointed to the next divisor — in this case 100. Since the number in AX is a remainder from dividing by 1,000, it must itself be less than 1,000. Dividing by 100 therefore gives the first digit, which is converted and sent to the destination.

The remainder now is less than 100, and can be converted to a two-digit decimal number by using the AAM instruction and then Oring both bytes with 30hex. The AH and AL portions have to be switched so that the Stosw instruction can be used to send both bytes to the destination. The destination now has the first five decimal digits of the eventual number.

The program continues by restoring the first remainder off the stack and setting up the CX register to count three times around a divide loop. The loop takes the number in DX, moves it to AX, divides it by the divisor indicated in SI, corrects the answer and sends it to the destination.

This is done three times, sending successively the 1,000, 100s and 10s digits of the decimal number. The final remainder — which is in DL, since it must be less than 10 — is corrected and sent to the destination. There is now an eight-digit decimal number in ASCII format at the destination. The pointer is restored from the stack, and CX is set to count to 7.

STRIPS ZEROS

The next series of instructions is at Hexloop2. It checks each digit in turn to see if it is an ASCII zero (30hex), and if so replaces it by a space. If it is not a zero, processing exits the loop, leaving the rest of the destination buffer intact. This effectively removes all leading zeros except the last one, to give a neat buffer capable of immediate display. The destination has been set to the Asc_Tot section of the message, so when the whole message is displayed the numbers are already filled in.

The same process is completed in the Filnum routine, with the exception that only three digits are checked for zero suppression. There is one extra instruction that swaps the contents of the DI and DX registers. It has no effect during Filnum, but is used by the Divide routine to indicate the

position in the destination buffer where the decimal point will be placed. Each time that the Filnum routine is completed, on exit DX contains the position reached in the destination buffer.

The Divide routine produces a number with two decimal places indicating the number of floppy discs required. This is achieved in a similar way, except that this time it is necessary to divide by the capacity of a floppy disc, which is way above the 16-bit limit: the actual number in hexadecimal would be 058800. In this case, it is convenient to shift the divisor right by eight bits, and then to shift the quotient by the same amount. The arithmetic equivalent of this is division by 1/256th of a floppy, and then division by a further 256. There is no need to do an explicit division here though. All you have to do is access the high byte in AH and convert it to ASCII via Filnumo.

HOW MANY FLOPPIES?

Once the integer section of the answer from AH has been shown, the position in the destination buffer must be restored to DI and then used to send a decimal-point character. The final arithmetic operation recovers the complete quotient of the previous division,

zeros the AH portion of it and the whole of DX, remultiplies it and adds back the previous remainder to give the number of bytes required on the remaining floppy disc. This figure is divided by 100 decimal, giving the number of hundredths of a floppy for conversion to ASCII and eventual display.

When it returns from the Divide routine, the program displays the completed final message and puts things back as it found them by resetting the original DTA. Function 4Chex is used to exit instead of interrupt 20hex. It is the MS-DOS approved way to end a program, since it completes a certain amount of tidying up and can also be used to return an error code to the calling program. If you have version 1 of MS-DOS you should use interrupt 20hex. **[P]**

All the programs in this series are available on IBM-formatted discs at a cost of £5 for each program. Each disc contains the assembler source code, the assembled program and a document file describing the operation of the code in detail. Please send your order to Jim Bates, c/o Practical Computing; cheques should be made payable to Jim Bates.

MicroProcessor Engineering Ltd

133 HILL STREET
SHIRLEY
SOUTHAMPTON SO1 5AF



Tel: 0703 631441

FORTHS

For IBM PC and Compatibles

Modular Forth — award winning Forth 83 £475.00
very fast, multitasking, GEM, modules, 8087 fp

WorkFORTH

- ViewTrace Debugger £45
- Software Floating Point £45
- 80x87 Floating Point £45
- Windows & Graphics £45
- Documentation Tool Kit £45

WorkFORTH Development Kit £145
includes ViewTrace, SoftFP, Doc Tools

For 680x0 Systems

- MPE-Forth/68K OS9/68K — fast £375
- MPE-Forth/68K CPM/68K — fast £375
- GEM-Forth/ST Atari ST — GEM i/f, fast £65
- MVP — Forth Amiga £150
- MM MasterForth Macintosh £125

Others

UniForth for RT11, RSX11, VMS
(inc micro) £175-£675



Software & Tools for Engineers

CROSS-COMPILERS

For PC DOS, MSDOS, OS9/68K, CPM/68K
CPM80, OS9/6809, FLEX

for generating new Forth applications, including ROM based turnkey systems fast, interactive, debuggable code, high or low level interrupts, technical support, source code, debug & download tools, cross assembler included. Practical solutions to real problems.

- Cross Compiler core £250
- Targets include source, RAM and ROM versions
- Forth-83 targets £225
- Z80, 80x86/8, 680x0
- Fig-Forth targets £175
- 6502/11Q, 8080/5, Z80/64180, 80x86/8, 1802, Z8, 6800/6303, 6809, 680x0, 99xxx
- Forth-79 targets £350
- Bryte Forth 8031/44/51

HARDWARE for PCs

- EPROM Programmer 2716-27512 £145
- PAL Programmer MMI, NS, TI 20/24 pin £325
- GAL/EPLD Programmer Lattice/Altera 20/24 pin £350
- NOVIX 5Mips co-processor — ready for NC5000 £852
- MVP Microcoded — includes microcode tools £1225

He probably didn't know a VAN from a LAN either

But Einstein had an excuse.
Fortunately you don't any longer.

The new easy to use **Breaking The Jargon** not only provides you with definitions of computer terms, it also gives you an idea of how the terms are used.

As an example, LAN stands for local area network—great you say, but what's a local area network? **Breaking The Jargon** explains it all. This new lexicon is based on a series called Background Briefing which appeared in Computer Weekly from November 1986 to March 1987, written by respected computer journalist Nicholas Enticknap. He's made it simple to find a simple definition, and simple again to understand the full meaning.

Breaking The Jargon is just the first in a new series of Computer Weekly publications designed to give practical guidance in areas of interest to readers.

This reference book is essential for all

companies using computers, for the 80's business person who comes into contact with computers, or anyone who has an interest in computers. No office or briefcase should be without one.

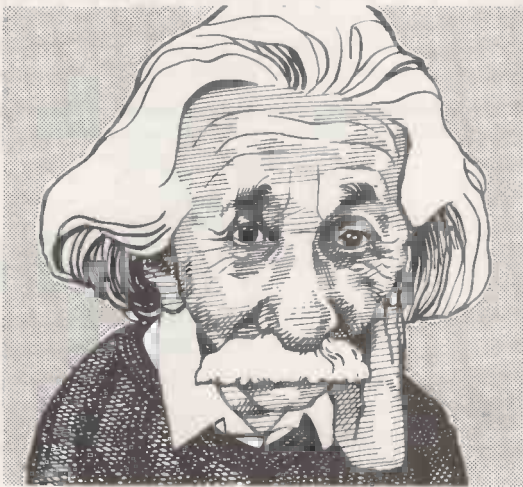

Einstein surely would have found a computer useful in his work and **Breaking The Jargon** might have been his first step. Make it yours. Order now—**Breaking The Jargon** will be available after June 1, 1987 for just £8.95 (including p&p). Reserve your copy today by returning the coupon. Send to:— Computer Posting, 120-126 Lavender Avenue, MITCHAM, Surrey CR4 3HP or place a phone order by ringing them on 01-685 9435.

Please send me _____ copy/ies of **Breaking The Jargon** at £8.95 per copy including post and packing (for despatch outside the UK, overseas prices on request.)

Choose one option:

I enclose a cheque/PO for £_____ payable to Reed Business Publishing.

Charge my credit card account £_____ to pay Reed Business Publishing.

Amex Access VISA Diners (please tick here)

My card number is

--	--	--	--	--	--	--	--	--	--	--	--	--	--	--	--	--

My card expires on _____

Signature _____

Full despatch address/credit card registered address.

Name _____

Address _____

Postcode _____

Return to Computer Posting, 120-126 Lavender Avenue, MITCHAM, Surrey CR4 3HP or ring 01-685 9435 and place your credit card order.

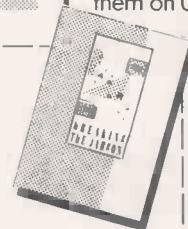

(Bulk prices available on request)

Breaking The Jargon
Available after June, 1987
Allow 28 days for delivery

Computer Weekly

Published by Reed
Business Publishing

PC

CLASSIFIED

**PRACTICAL COMPUTING,
REED BUSINESS PUBLISHING
QUADRANT HOUSE
THE QUADRANT
SUTTON SURREY SM2 5AS
TEL: 01-661 3033**

COMPUTER PROBLEMS?

WE HAVE THE SOLUTIONS

Not all data switches and converters are the same. Check these features when selecting your next purchase.

DO THEY INCLUDE:	Us	Them
*Computer and Printer Cables	✓	?
Direct from manufacturer from stock	✓	?
Attractive styling and small size	✓	?
No quibble guarantee	✓	?
Experienced technical support	✓	?
Competitive pricing	✓	?
1st class postage and packing	✓	?
Customised versions available	✓	?

WE DO!

*Converters include printer cables. Additional Cables at reduced prices. Ring us for quotation or further information about our comprehensive range of data switches, data converters and low cost computer cables; or write to (no stamp required).



TYEPRO LIMITED

Freepost, 30 Campkin Road,
Cambridge CB4 1BR
Telephone: (0223) 322394

MEDIA CONVERSIONS

DISK/DISK • TAPE/DISK • TAPE/TAPE

We can transfer your data between over 1000 different Minis, Micros and Mainframes.

Tape

1/2" - 800, 1600, 3200, 6250 BPI

3/4" - QIC-11, QIC-24, (QIC-02).

DEC 'DOS', TAR, ANSI, CPIO, IBM Labelled/Unlabelled.

Floppy

8", 5 1/4", 3 1/2", 3" CPM, CPM86, MDOS, MSDOS, PCDOS, UNIX, XENIX, IDRIS, TAR, RT11, IBM, BEF, ISIS, FLEX, OS9, APPLE, ACORN, TORCH, VICTOR-SIRIUS, ATARI etc.

WP/Typesetting

Many formats including DISPLAYWRITER, OLIVETTI, WORDPLEX, LINOTYPE etc.

Overnight - Most formats returned by next day's post.

Prices from £10 per disk.
Usual terms C.W.O.
Ring or write for a full format list.



A.I.L. DOWNLOADING SERVICES

VOYSEY HOUSE
BARLEY MOW PASSAGE
LONDON W4 4PT
01-994 5471

DISK COPYING SERVICE

Moving data and program files from one machine to another is often made difficult because different manufacturers have adopted different disk format standards.

We can copy your files to and from over 250 disk formats including CP/M, CP/M-86, MS-DOS, PC-DOS, ISIS, APPLE, SIRIUS, TORCH, APRICOT, HP150, DEC RT-11, and IBM BEF.

Disks are normally despatched on the day they are received.

Our charge is £10.00 + disk + VAT.
Special prices for quantities.

For more information call us.

GREY MATTER

4 Prigg Meadow, Ashburton, Devon TQ13 7DF.
TEL. (0364) 53499 10

COMPUTER CLEANERS

*****STOP LOCK UPS*****

Do you suffer lost data or lock-ups? Do you think mains is the cause? If so then our sockets may be the solution.

As well as cutting high voltage spikes they smooth the cut spikes and filter RF from 1-30MHz (better than 40db) and up to 130MHz. Now with Three spike filters
Adaptor (socket) (5a fuse) - £14 incl.
Adaptor (3-sockets) (5a fuse) - £18 incl.
Trailing 4-way socket (13a fuse) - £24 incl.
Simply plug in - no wiring

Telex: 265451. MONREF G (quoting BT GOLD 72: MAG90645)

Tony Firshman Services
12 Bouverie Place London W2 1RB 01-724 9053

RAIR BLACK BOX and ICL PCs (8 bit). Bought sold exchange repaired advice given. Ring 0734 668951 (Reading). 267M

SIRIUS/IBM & Compatibles Public Domain software incl. Transfer pack send large sae to M. Palaci 122 Kilburn High Road, London NW6 4HY.

IBM-PC Public Domain Software from only £3/disc. NO MEMBERSHIP FEES. Send S.A.E. for catalogue to: PC-STAR, P.O. BOX 164 Cardiff CF5 3YB.

ATARI ST OWNERS - Write now for a free copy of our latest Newsletter and Public Domain Library Catalogue: St-Club, PO Box 20, Hertford, SG13 8NN. (stamp appreciated).

SIRIUS EXPANSION: 512K RAM, £185, clock + card £65. New ROM's £32 (inclusive). ISSUE. 18 Norfolk Road, Brighton BN1 3AA. (0273) 736880. 457M.

JUKI 6100 daisywheel printer, 20cps. As new - still boxed, £130ono. BBC-B plus/disk drive/monitor/progs. All hardly used - £POA. Tel: Maidenhead (0628) 822937. Eve/weekends only. 471M

SIRIUS-1, 640K. Incl issue's latest high speed memory. Twin 1-2Mb floppies. Latest boot ROM's. MS-DOS 1.25, CP/M, micro-modeller. Kermit software and lead for PC transfer, £700ono. Call Roger 01-727 3838. Answerphone. 463M

FLOPPIES. Clearance of brand new 5 1/4", high quality, sleeved, DSDD floppy disks. £50 per 100+ p&p. Reading 701163. Evenings, 464M

PROTECT DATA EXTEND HEAD LIFE REDUCE ERRORS

WITH FLOPPY CLEANICA

THE UNIQUE
MICROWAVE-MACHINED
SOFT POLYESTER
CLEANING DISC

- Safe design containing no magnetic materials or compounds
- No messy liquids or 'one time' cleaning pads
- Simple 15 second cleaning cycle for both double or single sided drives
- Economic lifespan gives 150 operations with usage chart

FLOPPY CLEANICA is manufactured by Audio Technica, a world-wide name in precision made products, and maintains disc drive heads in optimum condition for minimum read/write error.

Order directly today by mail (cheque/p.o.) or credit card telexales.

FLOPPY CLEANICA £19.95 INC. P&P
Please state 5.25" (ATC-205) or 3.5" (ATC-203) DRIVE



audio-technica

Technica House, Lockwood Close, LEEDS LS11 5UU.
TELESALES (0532) 771441

AMIGA DEVELOPERS System. Twin drives, 512K RAM. Full set, ROM/Hware, manuals, development software. Best offer. Around £1,100 secures. All excellent condition. Will deliver. Tel; Steve 0752-346555 (day-time). 459M.

ZENITH Z-181. IBM/Compat. Portable, 4 months old. Superb screen. Cig/llghter lead, mains adaptor, bag. £1,340. (£2,129 new). Boxed w/manuals. 01-444 8344. 460M

IBMPC 10 MEG, 640K, Hercules, 2 ser/par, Multimate, Lotus, dBase, Samna4. Super project, framework2, Datamaster, Xchange, smart term 220. Turbo-P, Wordstar, Norton, Peachtree + more. No split, £1,950ono. 01-543 6585. 461M.

dBASE II/III Custom Software Development. Easy telecommunications for speedy file transfer. Low rates, quick application development. EasyLink 6290 9922. KN Associates, 114-8th Street, Ann Arbor, Michigan 48103. 462M

CANON PJ1080A colour ink jet. Printer, brand new, IBM-PC compatible. New, price £500 +. For sale at £350ono. Tel: 01-836 8751 ext 252 office. 0932-226786. Evenings. 465M

BERNOULLI BOX cartridges by Iomega. Tri-Paks 3 x 10MB £129; 3 x 20MB £164. SGLS 10MB £48, £20MB £59. All plus VAT, p&p. Frithwood Computing Ltd, 13 Cullera Close, Northwood, HA6 3SE. Tel: 09274 21942. 467M

IBM PC with 8086 board, 4.77/10Mbz clock, 640K RAM, twin floppies plus 20/20 Mbyte, hard disk/tape, streamer monitor, keyboard and manuals, £995. Tel: 01-886 4200. 468M

RICHO 1600Q 55cps, daisywheel printer as new, £495. FACIT 40cps daisy wheel with sheetfedder, £4545. QUME 11/40 printer £450. Tel: 01-886 4200. 469M

FRAMEWORK-2. Version 1.1. (IBM PC). Hardly used, in makers box, £200. Tel: 0297 23072. 470M

PC/AT COMPATIBLES

BREAKING THE PRICE BARRIER!!!!!!
 MANUFACTURED IN THE UNITED KINGDOM
 USING HIGHEST QUALITY JAPANESE PRODUCTS

PC/XT £380
PC/XT, 20MB,
MONITOR TTL £780

★ 8088/V20 ★ 640k
 ★ "NEC" FLOPPY DRIVE ★ "SERIAL/PARALLEL" PRINTER PORT
 ★ HERCULES GRAPHICS DISPLAY ADAPTOR ★ KEYBOARD NUMS +
 CAPS LOCK ★ 8 SLOTS ★ FLAT SCREEN MONITOR

AT/TURBO £949
WITH 20MB
MONITOR £1280

★ DYNAMIC SPEED CONTROL ★
 ★ 80286 6/8/12 MHZ ★ 512K RAM EXPANDABLE TO 1M
 ★ LEGAL BIOS ★ FLOPPY DRIVE 1.2M
 ★ PRINTER PORT ★ GRAPHICS DISPLAY ADAPTOR ★ AT STYLE KEYBOARD
 WITH SEPARATE CURSOR PAD

★ **NEW 386 TURBO £2900** ★
 MONITOR, 20MB HARD DISK, 640K RAM, 1.2MB FLOPPY KEYBOARD, DOS 3.2
 ALL SYSTEMS ARE TOTALLY COMPATIBLE
 ★ REST TTL MONITOR 659 20MB HARD DISK £299
 BILINGUAL SYSTEMS EXPORT ORDERS WELCOME
 12 MONTHS WARRANTY AND SUPPORT EXCLUDED PRICES EXCLUDING VAT
 FOR ORDERS AND ENQUIRIES PLEASE CONTACT

C.A.S. COMPUTER POINT LTD
TEL 01-708 3775/01-708 2734
TLX 8952387 ANSWER G

→ circle 158 on enquiry card ←

dClock II

The Original Slotless Clock/Calendar

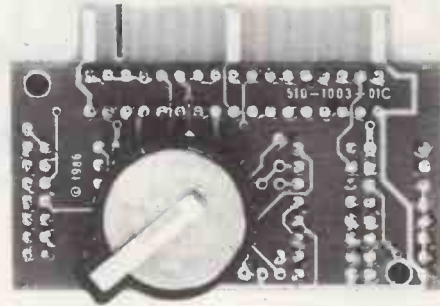

*Actual size

- * No expansion slot required.
- * Precision made.
- * Extremely accurate.
- * Full feature time piece.
- * 100 years calendar.
- * Easy to install.
- * Plugs onto disk drive.
- * Can be installed in less than 5 minutes.
- * Designed for professionals.
- * Used by Major organisations & Government Departments.

dCLOCK II is suitable for most PC's ie: PC, AT, Texas Instrument and Turbo types, so long as they run DOS 2 or later and have at least one standard disk drive.

£69.95 (for postal deliveries please add £1.50 p&p) exc VAT.

Telephone or credit card orders, phone 03526 61991 or 03526 4559 or write: **Bentley (Computers) Limited**, Unit 23, Manor Industrial Estate, Flint, Clwyd CH6 5UY.

*If dCLOCK II proves unsuitable for use with your computer you may return it within 14 days for a full refund.



→ circle 159 on enquiry card ←

PRACTICAL COMPUTING

Advertisement Index

A					
ABC Systems Ltd	54	Epson (UK) Ltd	20/21	O	
ACE Micro Systems	86	F		Opus Supplies Ltd	52/53
AC Interactive	28	Fraser Associates	58	P	
Alltech	102	G		Plus 5	68
AMA	65	Gultronics Computer Centre	74	Polanka Video Ltd	86
Apple Computers	30/31	H		Q	
Apricot UK	32/33	Hewlett Packard Ltd	10/11	Qume UK	66
Aslan Computer Services	86	Hitachi	19	R	
Atari UK Ltd	38/39, 41	Homestead Data Products	62	Ringdale Peripherals	9
B		HM Systems Ltd	4	Rotherham Computer Centre	28
Bentley Computer Ltd	114	I		S	
Bits Per Second	98	IBM (UK) Ltd	16/17	Sentinel Software Ltd	37
Borland International	2/3	ISD International	64	Silica Shop	51
British Olivetti	8	ITT Marketing	73	Sirton Computer Systems	72
Brom Com Computers Ltd	75	K		SK Microsystems	34
C		KCP	35	Star Micronics (UK) Ltd	15
Cambridge Computer Solutions	103	L		T	
CAS Computer Point	114	Laboratory Software	62	Taxan (UK) Ltd	25
Compumart	22	M		Trisoft	50
Computer Deals	70	MCS	104	W	
Computer Express	80	MDS	85	Worldwide Ltd	59
D		Megatech Corporation	63	X	
Damson Computing	106	Microft Technology Ltd	55,85	XON Software	26
Data Marketing	98	Micro Peripherals	Back Cover	Z	
Dataplus Sales Ltd	84	MicroProcessor Engineering	111	Zenith Data Systems	6
Diamond Computers	28	Micro Rent	24		
E		Microcosim Research	98		
Elite Computer Systems	64	Moorhouse Marketing	62		
Elonex (UK) Ltd	Inside back cover	Mountandene	85		

XT-Compatible 20 Megabytes 4.77/8 MHz

£795

"All prices excluding VAT"

- The PC88 Turbo
- Legal BIOS
- NEC V-20 Super Processor
- Switchable 4.77/8 MHz Clock
- 640K RAM
- 20MB Half Height Hard Disk
- 360K Half Height Floppy
- Parallel Printer + RS232 Serial Ports
- Clock/Calendar with Battery Back-up.
- Monographic/Printer card
- 130W Power Supply
- Professional Keyboard
- "Hi-Res 12"" Green Monitor
- MS-DOS 3.2
- Full Set of Manuals
- 8 Expansion Slots
- 12 Months Warranty

AT-Compatible 20 Megabytes 6/8/10 MHz

£1295

0 or 1 Wait States

"All prices excluding VAT"

- The PC-286 Turbo
- Legal Bios
- Switchable 6/8/10 MHz
- 640K RAM
- 20 MB Half Height Hard Disk
- 1.2 MB Half Height Floppy
- Parallel Printer + Two RS232 Serial Ports
- Clock/Calendar with Battery Back-up
- Monographic/Printer card
- 200W Power Supply
- Professional Keyboard
- "Hi Res 14"" Green Monitor
- MS-DOS 3.2
- Full Set of Manuals
- 8 Expansion Slots
- 12 Months Warranty

OPTIONS

- 30 MB Hard Disk Drive Upgrade £265
- 40MB Hard Disk Drive Upgrade £365
- 14" Colour Monitor Upgrade £175
- 14" Hi Res Colour Monitor and EGA Card Upgrade £395
- EGA Card £165

'ON SITE MAINTENANCE AVAILABLE'

"All prices excluding VAT"



ELONEX (UK) Ltd.

Please feel free to visit our showroom for demonstration

**RAYS HOUSE, NORTH CIRCULAR ROAD, STONEBRIDGE PARK,
LONDON NW10 7XB TELEPHONE: 01-965 3225**



MP 165 DOT MATRIX

This proven best selling NLQ printer offers the user the very best in low cost matrix printing.

Speed: 160cps (Draft), 35cps (NLQ). Columns: 80. Compatibility: IBM/Epson. Price: £229.

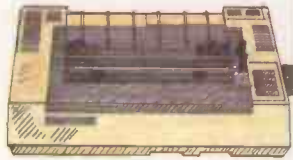

MP 200 DOT MATRIX

A fast NLQ quality printer, using the latest state of the art technology - IC Font Cards.

Speed: 200cps (Draft), 40cps (NLQ). Columns: 80. Compatibility: IBM/Epson. Price: £329.



MP 201 DOT MATRIX

This 136 column, 200cps, NLQ printer offers the best value in the market place - you can't buy better. A range of Font Cards are available.

Speed: 200cps (Draft), 40cps (NLQ). Columns: 136. Compatibility: IBM/Epson. Price: £349.

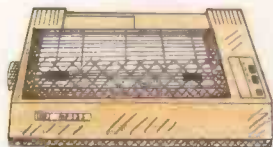

MP 135 DOT MATRIX

A low cost, high performance printer using the latest technology to produce print that makes draft quality look like NLQ.

Speed: 135cps (Draft), 27cps (NLQ). Columns: 80. Compatibility: IBM/Epson. Price: £169.

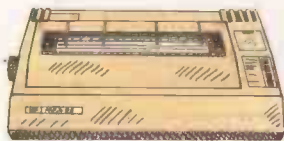

MP 480 DOT MATRIX

Another prime example of Micro Peripherals bringing fantastic value for money in a 480cps dot matrix printer at less than a pound per character per second.

Speed: 480cps (Draft), 74cps (NLQ). Columns: 80. Compatibility: IBM/Epson. Price: £369.



MP 26 DAISYWHEEL

A feature rich very quiet (57dB) printer. Universal compatibility with almost all personal computers at an unbeatable price.

Speed: 26cps. Columns: 132. Compatibility: Diablo 630 Interface: Parallel + serial. Price: £259.



MP 40 DAISYWHEEL

A very fast, quiet printer packed with features and compatible with virtually all computers and at a fantastic price.

Speed: 40cps. Columns: 132. Compatibility: Diablo 630 Interface: Parallel + serial. Price: £379.



Our printer's produce words faster than you can say them (at prices we like to shout about).

Producing words isn't the only thing Micro Peripherals printers do fast. With quality features you'd normally find on more expensive machines, they sell fast as well.

Whether you want high speed performance, high resolution graphics or a choice of type styles to make you look good on paper, the Micro Peripherals range has the printer to suit your needs and your pocket, as well as a full 2 year warranty*.

Micro Peripherals printers are compatible with most micros, including Amstrad, IBM, Acorn and Compaq. For more information call us for free on 0800 521111 now.



Intec 2, Wade Road, Basingstoke, Hampshire RG24 0NE.
Telephone: 0256 473232.
Telex: 859669 MICRO P G Facsimile: 0256 461570.

Units 5 & 6, Newhallhey Road, Rawtenstall,
Rossendale, Lancashire BB4 6HL.
Telephone: 0706 211526 Facsimile: 0706 228166.

* The 2 year warranty excludes printheads and ribbons.

All prices are RRP Ex. VAT.

IBM, Epson & Diablo are trade marks and are recognised